

**OBSOLETE PRODUCT
NO RECOMMENDED REPLACEMENT**
contact our Technical Support Center at
1-888-INTERSIL or www.intersil.com/tsc

September 26, 2001

FN7150

**400MHz GBWP Gain-of-2 Stable
Operational Amplifier**



The EL2074 is a precision voltage-feedback amplifier featuring a 400MHz gain-bandwidth product, fast settling

time, excellent differential gain and differential phase performance, and a minimum of 50mA output current drive over temperature.

The EL2074 is gain-of-2 stable with a -3dB bandwidth of 400MHz at $A_V = +2$. It has a very low 200µV of input offset voltage, only 2µA of input bias current, and a fully symmetrical differential input. Like all voltage-feedback operational amplifiers, the EL2074 allows the use of reactive or non-linear components in the feedback loop. This combination of speed and versatility makes the EL2074 the ideal choice for all op-amp applications at a noise gain of 2 or greater requiring high speed and precision, including active filters, integrators, sample-and-holds, and log amps. The low distortion, high output current, and fast settling makes the EL2074 an ideal amplifier for signal-processing and digitizing systems.

Pinout

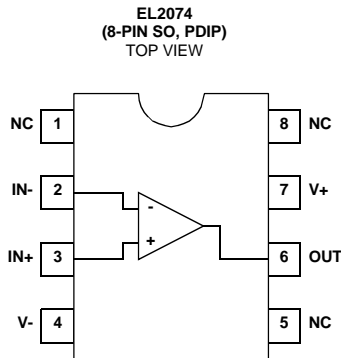

Features

- 400MHz gain-bandwidth product
- Gain-of-2 stable
- Ultra low video distortion = 0.01%/0.015° @NTSC/PAL
- Conventional voltage-feedback topology
- Low offset voltage = 200µV
- Low bias current = 2µA
- Low offset current = 0.1µA
- Output current = 50mA over temperature
- Fast settling = 13ns to 0.1%
- Low distortion = -55dB HD2, -70dB HD3 @20MHz, 2V_{pp}, $A_V = +2$

Applications

- High resolution video
- Active filters/integrators
- High-speed signal processing
- ADC/DAC buffers
- Pulse/RF amplifiers
- Pin diode receivers
- Log amplifiers
- Photo multiplier amplifiers
- High speed sample-and-holds

Ordering Information

PART NUMBER	PACKAGE	TAPE & REEL	PKG. NO.
EL2074CN	8-Pin PDIP	-	MDP0031
EL2074CS	8-Pin SO	-	MDP0027
EL2074CS-T7	8-Pin SO	7"	MDP0027
EL2074CS-T13	8-Pin SO	13"	MDP0027

Absolute Maximum Ratings ($T_A = 25^\circ\text{C}$)

Supply Voltage (V_S) $\pm 7\text{V}$
 Output Current Output is short-circuit protected to ground, however,
 maximum reliability is obtained if I_{OUT} does not exceed 70mA.
 Common-Mode Input $\pm V_S$
 Differential Input Voltage 5V
 Thermal Resistance (PDIP) $\theta_{JA} = 95^\circ\text{C/W}$

Thermal Resistance (PDIP) $\theta_{JA} = 175^\circ\text{C/W}$
 Maximum Die Temperature $+125^\circ\text{C}$
 Storage Temperature -65°C to $+150^\circ\text{C}$
 Lead Temperature 260°C
 Power Dissipation See Curves

CAUTION: Stresses above those listed in "Absolute Maximum Ratings" may cause permanent damage to the device. This is a stress only rating and operation of the device at these or any other conditions above those indicated in the operational sections of this specification is not implied.

IMPORTANT NOTE: All parameters having Min/Max specifications are guaranteed. Typical values are for information purposes only. Unless otherwise noted, all tests are at the specified temperature and are pulsed tests, therefore: $T_J = T_C = T_A$

Open-Loop DC Electrical Specifications

$V_S = \pm 5\text{V}$, $R_L = 100\Omega$, unless otherwise specified.

PARAMETER	DESCRIPTION	TEST CONDITIONS	TEMP	MIN	TYP	MAX	UNIT
V_{OS}	Input Offset Voltage	$V_{CM} = 0\text{V}$	25°C		0.2	1.5	mV
			T_{MIN}, T_{MAX}			3	mV
TCV_{OS}	Average Offset Voltage Drift	(Note 1)	All		8		$\mu\text{V}/^\circ\text{C}$
I_B	Input Bias Current	$V_{CM} = 0\text{V}$	All		2	6	μA
I_{OS}	Input Offset Current	$V_{CM} = 0\text{V}$	25°C		0.1	1	μA
			T_{MIN}, T_{MAX}			2	μA
PSRR	Power Supply Rejection Ratio	(Note 2)	All	60	80		dB
CMRR	Common Mode Rejection Ratio	(Note 3)	All	65	90		dB
I_S	Supply Current - Quiescent	No Load	25°C		21	25	mA
			T_{MIN}, T_{MAX}			25	mA
R_{IN} (diff)	R_{IN} (Differential)	Open-Loop	25°C		15		k Ω
C_{IN} (diff)	C_{IN} (Differential)	Open-Loop	25°C		1		pF
R_{IN} (cm)	R_{IN} (Common-Mode)		25°C		1		M Ω
C_{IN} (cm)	C_{IN} (Common-Mode)		25°C		1		pF
R_{OUT}	Output Resistance		25°C		20		m Ω
CMIR	Common-Mode Input Range		25°C	± 3	± 3.5		V
			T_{MIN}, T_{MAX}	± 2.5			V
I_{OUT}	Output Current		All	50	70		mA
V_{OUT}	Output Voltage Swing	No Load	All	± 3.5	± 4		V
$V_{OUT 100}$	Output Voltage Swing	100 Ω	All	± 3	± 3.6		V
$V_{OUT 50}$	Output Voltage Swing	50 Ω	All	± 2.5	± 3.4		V
$A_{VOL 100}$	Open-Loop Gain	100 Ω	25°C	500	1000		V/V
			T_{MIN}, T_{MAX}	400			V/V
$A_{VOL 50}$	Open-Loop Gain	50 Ω	25°C	400	800		V/V
			T_{MIN}, T_{MAX}	300			V/V
$e_N@ > 1\text{MHz}$	Noise Voltage 1MHz to 100MHz		25°C		2.3		nV/ $\sqrt{\text{Hz}}$
$i_N@ > 100\text{kHz}$	Noise Current 100kHz to 100MHz		25°C		3.2		pA/ $\sqrt{\text{Hz}}$

NOTES:

1. Measured from T_{MIN}, T_{MAX}
2. $\pm V_{CC} = \pm 4.5\text{V}$ to 5.5V
3. $\pm V_{IN} = \pm 2.5\text{V}$, $V_{OUT} = 0\text{V}$

Closed-Loop AC Electrical Specifications $V_S = \pm 5V$, $A_V = +2$, $R_F = R_G = 250\Omega$, $C_F = 3pF$, $R_L = 100\Omega$ unless otherwise specified.

PARAMETER	DESCRIPTION	TEST CONDITIONS	TEMP	MIN	TYP	MAX	UNIT
SSBW	-3dB Bandwidth ($V_{OUT} = 0.4V_{PP}$)	$A_V = -1$	25°C		400		MHz
		$A_V = +2$	25°C	250	400		MHz
			T_{MIN}, T_{MAX}	250			MHz
		$A_V = +5$	25°C		100		MHz
		$A_V = +10$	25°C		40		MHz
GBWP	Gain-Bandwidth Product	$A_V = +10$	25°C		400		MHz
LSBWa	-3dB Bandwidth	$V_{OUT} = 2V_{PP}$ (Note 1)	All	43	63		MHz
LSBWb	-3dB Bandwidth	$V_{OUT} = 5V_{PP}$ (Note 1)	All	17	25		MHz
GFPL	Peaking (< 50MHz)	$V_{OUT} = 0.4V_{PP}$	25°C		0	1	dB
			T_{MIN}, T_{MAX}			1	dB
GFPH	Peaking (> 50MHz)	$V_{OUT} = 0.4V_{PP}$	25°C		0	2	dB
			T_{MIN}, T_{MAX}			2	dB
GFR	Rolloff (< 100MHz)	$V_{OUT} = 0.4V_{PP}$	25°C		0.1	0.5	dB
			T_{MIN}, T_{MAX}			0.5	dB
LPD	Linear Phase Deviation (< 100MHz)	$V_{OUT} = 0.4V_{PP}$	All		1	1.8	°
PM	Phase Margin	$A_V = +2$	25°C		50		°
tr1, tf1	Rise Time, Fall Time	0.4V Step, $A_V = +2$	25°C		1.8		ns
tr2, tf2	Rise Time, Fall Time	5V Step, $A_V = +2$	25°C		8		ns
ts1	Settling to 0.1% ($A_V = -1$)	2V Step	25°C		13		ns
ts2	Settling to 0.01% ($A_V = -1$)	2V Step	25°C		25		ns
OS	Overshoot	2V Step	25°C		5		%
SR	Slew Rate	2V Step	All	275	400		V/ μ s
DISTORTION							
HD2a	2nd Harmonic Distortion	@ 10MHz, $A_V = +2$	25°C		-65	-55	dBc
HD2c	2nd Harmonic Distortion	@ 20MHz, $A_V = +2$	25°C		-55	-45	dBc
			T_{MIN}, T_{MAX}			-45	dBc
HD3a	3rd Harmonic Distortion	@ 10MHz, $A_V = +2$	25°C		-72	-60	dBc
HD3c	3rd Harmonic Distortion	@ 20MHz, $A_V = +2$	25°C		-70	-60	dBc
			T_{MIN}, T_{MAX}			-60	dBc
VIDEO PERFORMANCE (Note 3)							
dG	Differential Gain	NTSC	25°C		0.01	0.05	% _{PP}
dP	Differential Phase	NTSC	25°C		0.015	0.05	° _{PP}
dG	Differential Gain	30MHz	25°C		0.1		% _{PP}
dP	Differential Phase	30MHz	25°C		0.1		° _{PP}
VBW	± 0.1 dB Bandwidth Flatness		25°C	25	50		MHz

NOTES:

1. Large-signal bandwidth calculated using $LSBW = Slew\ Rate / 2\pi V_{PEAK}$.
2. All distortion measurements are made with $V_{OUT} = 2V_{PP}$, $R_L = 100\Omega$.
3. Video performance measured at $A_V = +2$ with 2 times normal video level across $R_L = 100\Omega$. This corresponds to standard video levels across a back-terminated 50 Ω load, i.e., 0–100IRE, 40IRE_{pp} giving a 1V_{PP} video signal across the 50 Ω load. For other values of R_L , see curves.

Typical Performance Curves

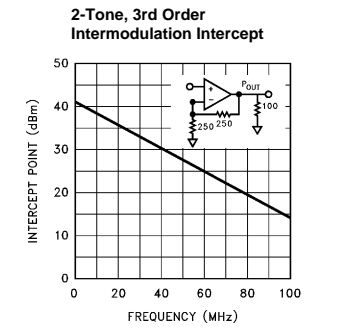
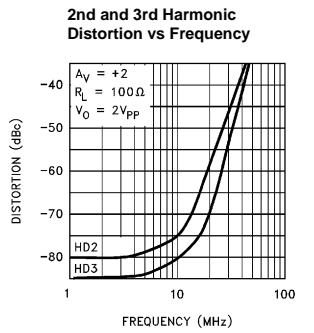
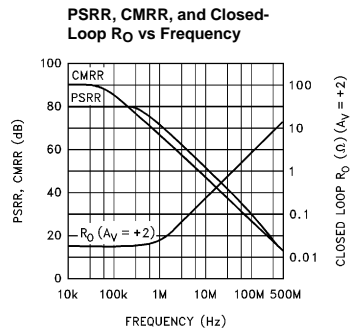
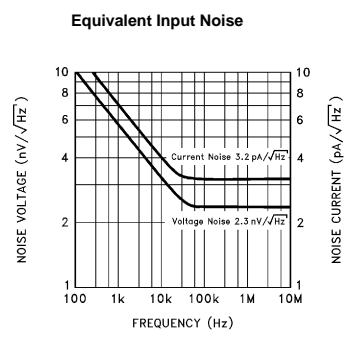
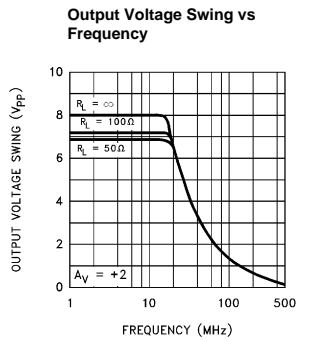
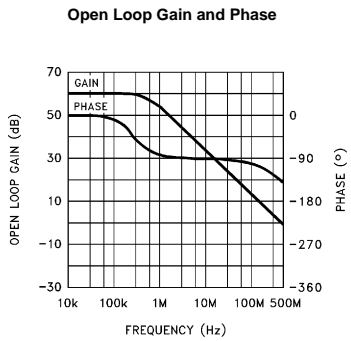
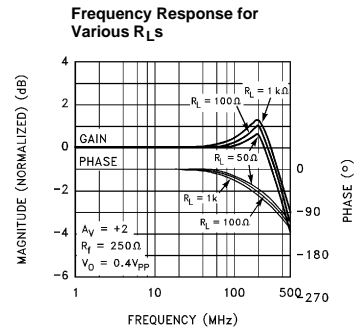
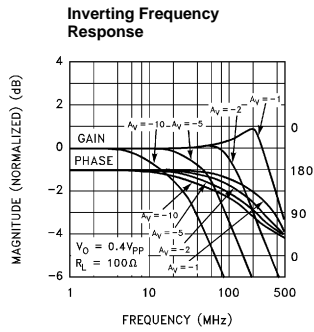
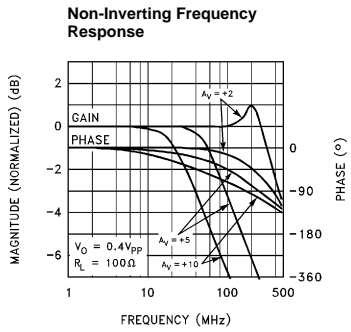

Typical Performance Curves (Continued)

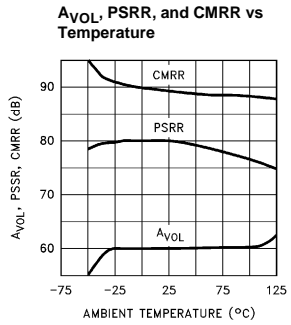
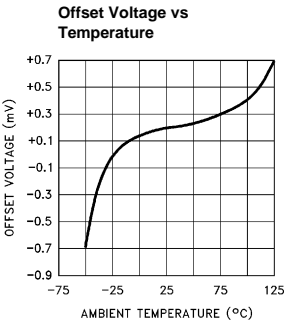
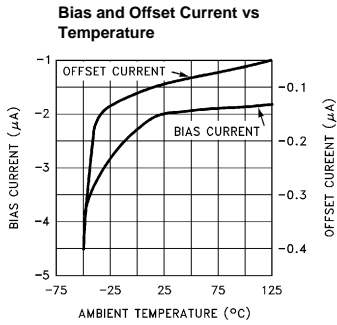
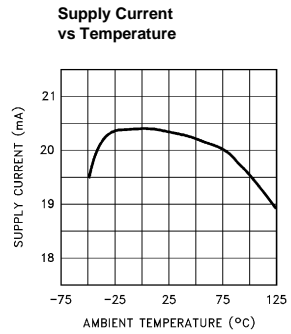
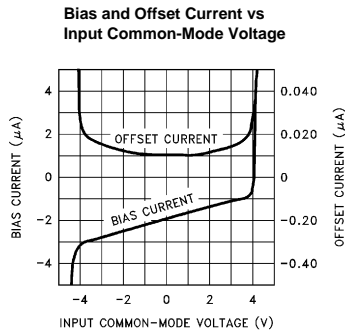
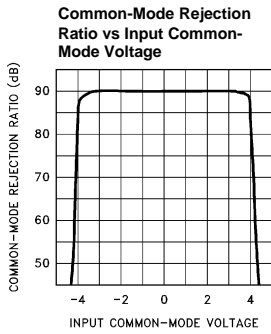
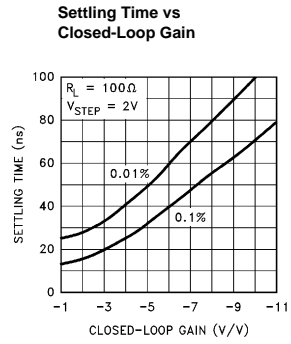
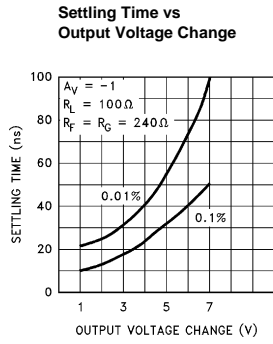
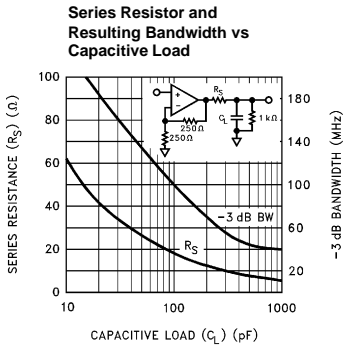

Typical Performance Curves (Continued)

Small Signal Transient Response

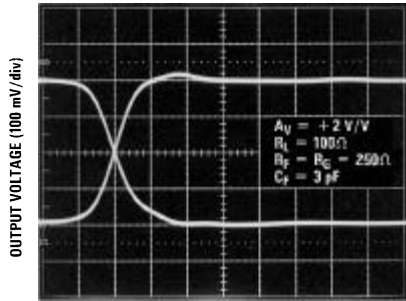

TIME (1 ns/div)

Large Signal Transient Response

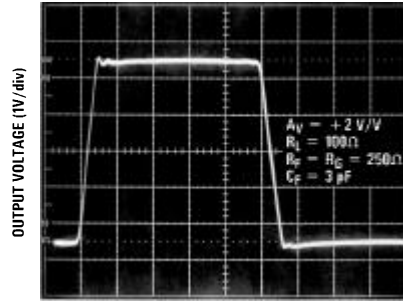

TIME (20 ns/div)

Differential Gain and Phase vs DC Input Offset at 3.58MHz

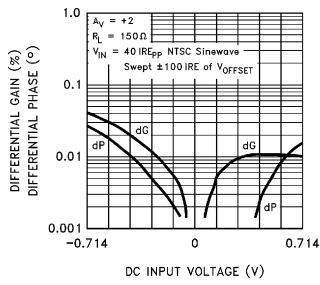

Differential Gain and Phase vs DC Input Offset at 4.43MHz

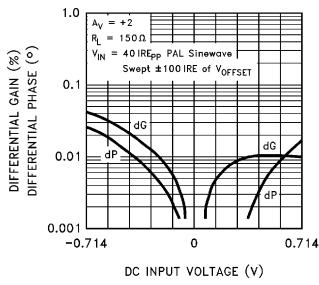

Differential Gain and Phase vs DC Input Offset at 30MHz

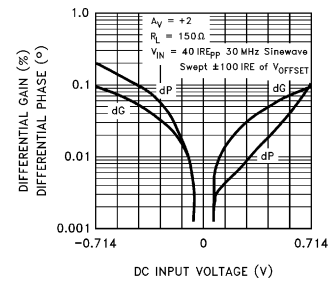

Differential Gain and Phase vs Number of 150Ω Loads at 3.58MHz

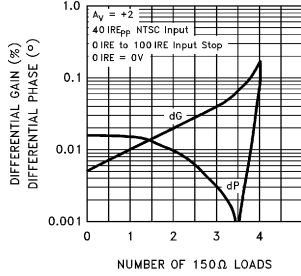

Differential Gain and Phase vs Number of 150Ω Loads at 4.43MHz

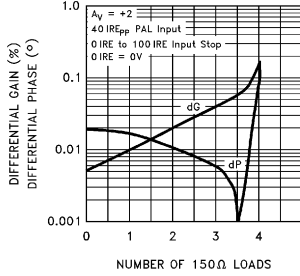

Differential Gain and Phase vs Number of 150Ω Loads at 30MHz

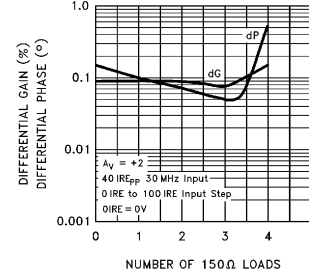

Equivalent Circuit

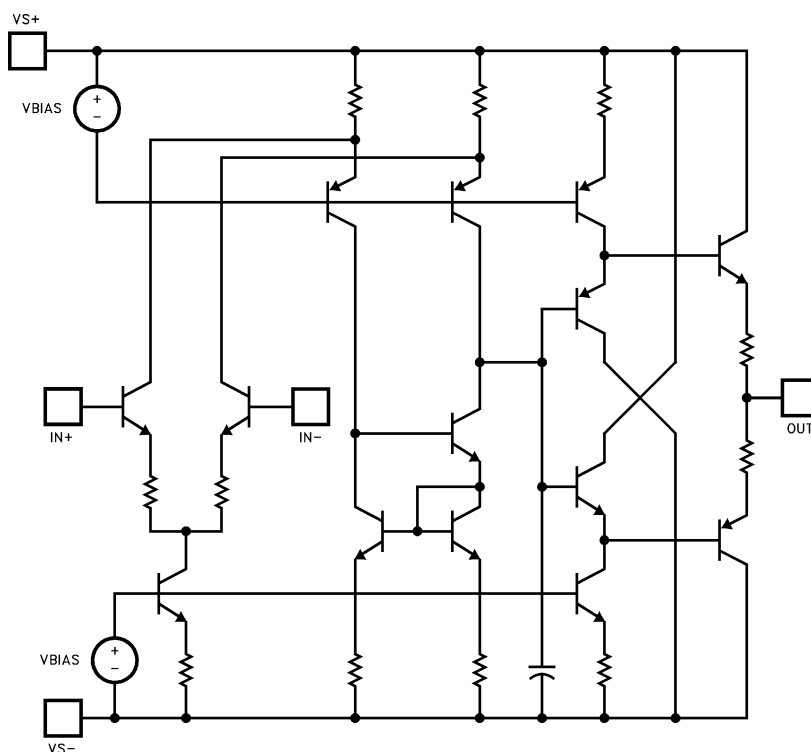

Burn-In Circuit

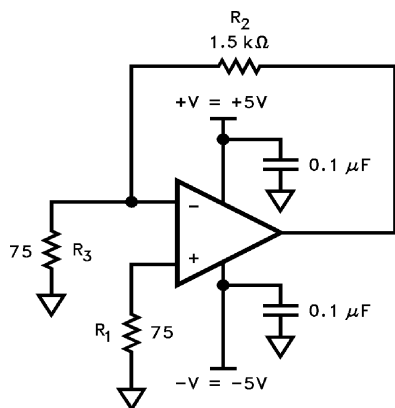

All Packages Use The Same Schematic

Applications Information

Product Description

The EL2074 is a wideband monolithic operational amplifier built on a high-speed complementary bipolar process. The EL2074 uses a classical voltage-feedback topology which allows it to be used in a variety of applications requiring a noise gain ≥ 2 where current-feedback amplifiers are not appropriate because of restrictions placed upon the feedback element used with the amplifier. The conventional topology of the EL2074 allows, for example, a capacitor to be

placed in the feedback path, making it an excellent choice for applications such as active filters, sample-and-holds, or integrators. Similarly, because of the ability to use diodes in the feedback network, the EL2074 is an excellent choice for applications such as log amplifiers.

The EL2074 also has excellent DC specifications: $200\mu\text{V}$, V_{OS} , $2\mu\text{A}$ I_{B} , $0.1\mu\text{A}$ I_{OS} , and 90dB of CMRR. These specifications allow the EL2074 to be used in DC-sensitive applications such as difference amplifiers. Furthermore, the current noise of the EL2074 is only $3.2\text{pA}/\sqrt{\text{Hz}}$, making it an excellent choice for high-sensitivity transimpedance amplifier configurations.

Gain-Bandwidth Product

The EL2074 has a gain-bandwidth product of 400MHz. For gains greater than 8, its closed-loop -3dB bandwidth is approximately equal to the gain-bandwidth product divided by the noise gain of the circuit. For gains less than 8, higher-order poles in the amplifier's transfer function contribute to even higher closed loop bandwidths. For example, the EL2074 has a -3dB bandwidth of 400MHz at a gain of +2, dropping to 200MHz at a gain of +4. It is important to note that the EL2074 has been designed so that this "extra" bandwidth in low-gain applications does not come at the expense of stability. As seen in the typical performance curves, the EL2074 in a gain of +2 only exhibits 1dB of peaking with a 100Ω load.

Parasitic Capacitances and Stability

When used in positive-gain configurations, the EL2074 can be quite sensitive to parasitic capacitances at the inverting input, especially with values $\geq 250\Omega$ for the gain resistor. The problem stems from the feedback and gain resistance in conjunction with the approximately 3pF of board-related parasitic capacitance from the inverting input to ground. Assuming a gain-of-2 configuration with $R_F = R_G = 250\Omega$, a feedback pole occurs at 424MHz, which is equivalent to a zero in the forward path at the same frequency. This zero reduces stability by reducing the effective phase-margin from about 50° to about 30° .

A common solution to this problem is to add an additional capacitor from the inverting input to the output. This capacitor, in conjunction with the parasitic capacitance, maintains a constant voltage-divider between the output and the inverting input. This technique is used for AC testing of the EL2074. A 3pF capacitor is placed in parallel with the feedback resistor for all AC tests. When this capacitor is used, it is also possible to increase the resistance values of the feedback and gain resistors without loss of stability, resulting in less loading of the EL2074 from the feedback network.

Video Performance

An industry-standard method of measuring the video distortion of a component such as the EL2074 is to measure the amount of differential gain (dG) and differential phase (dP) that it introduces. To make these measurements, a 0.286V_{PP} (40IRE) signal is applied to the device with 0V DC offset (0IRE) at either 3.58MHz for NTSC, 4.43MHz for PAL, or 30MHz for HDTV. A second measurement is then made at 0.714V DC offset (100IRE). Differential gain is a measure of the change in amplitude of the sine wave, and is measured in percent. Differential phase is a measure of the change in phase, and is measured in degrees.

For signal transmission and distribution, a back-terminated cable (75 Ω in series at the drive end, and 75 Ω to ground at the receiving end) is preferred since the impedance match at both ends will absorb any reflections. However, when double termination is used, the received signal is halved; therefore a gain of 2 configuration is typically used to compensate for the attenuation.

The EL2074 has been designed to be among the best video amplifiers in the marketplace today. It has been thoroughly characterized for video performance in the topology described above, and the results have been included as minimum dG and dP specifications and as typical performance curves. In a gain of +2, driving 150 Ω , with standard video test levels at the input, the EL2074 exhibits dG and dP of only 0.01% and 0.015 $^\circ$ at NTSC and PAL. Because dG and dP vary with different DC offsets, the superior video performance of the EL2074 has been characterized over the entire DC offset range from -0.714V to +0.714V. For more information, refer to the curves of dG and dP vs DC Input Offset.

The excellent output drive capability of the EL2074 allows it to drive up to 4 back-terminated loads with excellent video performance. With 4, 150 Ω loads, dG and dP are only 0.15% and 0.08 $^\circ$ at NTSC and PAL. For more information, refer to the curves for Video Performance vs Number of 150 Ω Loads.

Output Drive Capability

The EL2074 has been optimized to drive 50 Ω and 75 Ω loads. It can easily drive 6V_{PP} into a 50 Ω load. This high output drive capability makes the EL2074 an ideal choice for RF, IF and video applications. Furthermore, the current drive of the EL2074 remains a minimum of 50mA at low temperatures. The EL2074 is current-limited at the output, allowing it to withstand momentary shorts to ground. However, power dissipation with the output shorted can be in excess of the power-dissipation capabilities of the package.

Capacitive Loads

Although the EL2074 has been optimized to drive resistive loads as low as 50 Ω , capacitive loads will decrease the amplifier's phase margin which may result in peaking, overshoot, and possible oscillation. For optimum AC performance, capacitive loads should be reduced as much as possible or isolated via a series output resistor. Coax lines can be driven, as long as they are terminated with their characteristic impedance. When properly terminated, the capacitance of coaxial cable will not add to the capacitive load seen by the amplifier. Capacitive loads greater than 10pF should be buffered with a series resistor (R_S) to isolate the load capacitance from the amplifier output. A curve of recommended R_S vs Cload has been included for reference. Values of R_S were chosen to maximize resulting bandwidth without peaking.

Printed-Circuit Layout

As with any high-frequency device, good PCB layout is necessary for optimum performance. Ground-plane construction is highly recommended, as is good power supply bypassing. A 1 μ F–10 μ F tantalum capacitor is recommended in parallel with a 0.01 μ F ceramic capacitor. All pin lengths should be as short as possible, and all bypass capacitors should be as close to the device pins as possible. Parasitic capacitances should be kept to an absolute minimum at both inputs and at the output. Resistor values should be kept under 1000 Ω to 2000 Ω because of the RC time constants associated with the parasitic capacitance. Metal-film and carbon resistors are both acceptable, use of wire-wound resistors is not recommended because of parasitic inductance. Similarly, capacitors should be low-inductance for best performance. If possible, solder the EL2074 directly to the PC board without a socket. Even high quality sockets add parasitic capacitance and inductance which can potentially degrade performance. Because of the degradation of AC performance due to parasitics, the use of surface-mount components (resistors, capacitors, etc.) is also recommended.

EL2074 Macromodel

```

*
* Connections: input
*      | -input
*      | | +Vsupply
*      | | | -Vsupply
*      | | | | output
*      | | | | |
.subckt M2074 3 2 7 4 6
*
*Input Stage
*
ie 37 4 1 mA
r6 36 37 125
r7 38 37 125
rc1 7 30 200
rc2 7 39 200
q1 30 3 36 qn
q2 39 2 38 qna
ediff 33 0 39 30 1
rdiff 33 0 1 Meg
*
* Compensation Section
*
ga 0 34 33 0 2m
rh 34 0 500K
ch 34 0 0.8 pF
rc 34 40 50
cc 40 0 0.05 pF
*
* Poles
*
ep 41 0 40 0 1
rpa 41 42 150
cpa 42 0 0.5 pF
rpb 42 43 50
cpb 43 0 0.5 pF
*
* Output Stage
*
ios1 7 50 3.0 mA
ios2 51 4 3.0 mA
q3 4 43 50 qp
q4 7 43 51 qn
q5 7 50 52 qn
q6 4 51 53 qp
ros1 52 6 2
ros2 6 53 2
*
Power Supply Current
*
ips 7 4 11.4 mA
*
Models
*
.model qna npn(is800e-18 bf170 tf0.2 ns)
.model qn npn(is810e-18 bf200 tf0.2 ns)
.model qp pnp(is800e-18 bf200 tf0.2 ns)
.ends

```

EL2074 Macromodel (Continued)

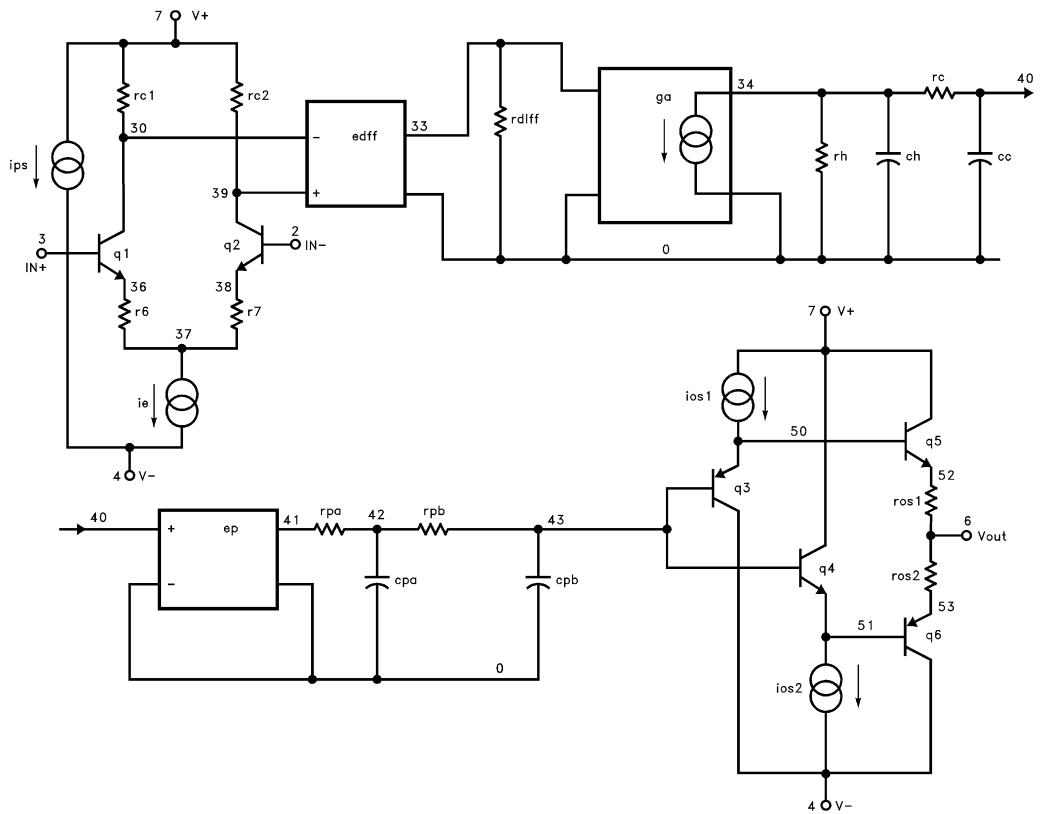

All Intersil U.S. products are manufactured, assembled and tested utilizing ISO9000 quality systems.
 Intersil Corporation's quality certifications can be viewed at www.intersil.com/design/quality

Intersil products are sold by description only. Intersil Corporation reserves the right to make changes in circuit design, software and/or specifications at any time without notice. Accordingly, the reader is cautioned to verify that data sheets are current before placing orders. Information furnished by Intersil is believed to be accurate and reliable. However, no responsibility is assumed by Intersil or its subsidiaries for its use; nor for any infringements of patents or other rights of third parties which may result from its use. No license is granted by implication or otherwise under any patent or patent rights of Intersil or its subsidiaries.

For information regarding Intersil Corporation and its products, see www.intersil.com