

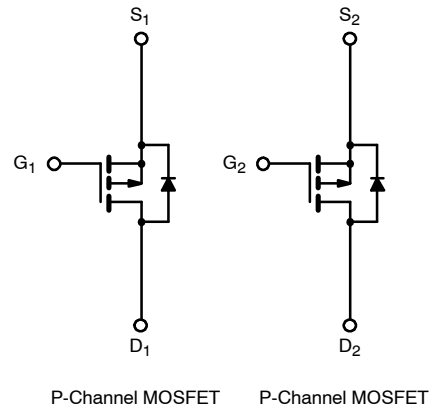

Dual P-Channel 2.5-V (G-S) MOSFET

PRODUCT SUMMARY		
V_{DS} (V)	$r_{DS(on)}$ (Ω)	I_D (A)
-20	0.155 @ $V_{GS} = -4.5$ V	± 2.9
	0.180 @ $V_{GS} = -3.6$ V	± 2.7
	0.260 @ $V_{GS} = -2.5$ V	± 2.2

TrenchFET[®]
Power MOSFETS
2.5-V Rated

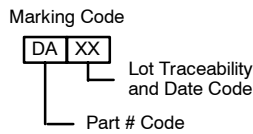
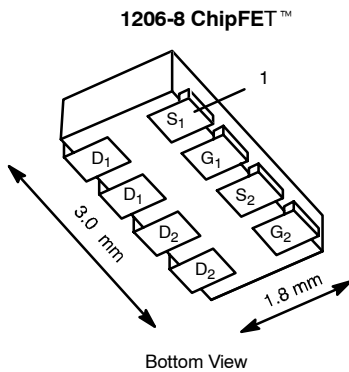

Ordering Information: Si5903DC-T1

ABSOLUTE MAXIMUM RATINGS ($T_A = 25^\circ\text{C}$ UNLESS OTHERWISE NOTED)				
Parameter	Symbol	5 secs	Steady State	Unit
Drain-Source Voltage	V_{DS}	-20		V
Gate-Source Voltage	V_{GS}	± 12		
Continuous Drain Current ($T_J = 150^\circ\text{C}$) ^a	I_D	$T_A = 25^\circ\text{C}$	± 2.9	± 2.1
		$T_A = 85^\circ\text{C}$	± 2.1	± 1.5
Pulsed Drain Current	I_{DM}	± 10		A
Continuous Source Current (Diode Conduction) ^a	I_S	-1.8	-0.9	
Maximum Power Dissipation ^a	P_D	$T_A = 25^\circ\text{C}$	2.1	1.1
		$T_A = 85^\circ\text{C}$	1.1	0.6
Operating Junction and Storage Temperature Range	T_J, T_{stg}	-55 to 150		$^\circ\text{C}$
Soldering Recommendations (Peak Temperature) ^{b, c}		260		

THERMAL RESISTANCE RATINGS					
Parameter		Symbol	Typical	Maximum	Unit
Maximum Junction-to-Ambient ^a	$t \leq 5$ sec	R_{thJA}	50	60	$^\circ\text{C/W}$
	Steady State		90	110	
Maximum Junction-to-Foot (Drain)	Steady State	R_{thJF}	30	40	

Notes

- Surface Mounted on 1" x 1" FR4 Board.
- See Reliability Manual for profile. The ChipFET is a leadless package. The end of the lead terminal is exposed copper (not plated) as a result of the singulation process in manufacturing. A solder fillet at the exposed copper tip cannot be guaranteed and is not required to ensure adequate bottom side solder interconnection.
- Rework Conditions: manual soldering with a soldering iron is not recommended for leadless components.



SPECIFICATIONS (T _J = 25 °C UNLESS OTHERWISE NOTED)						
Parameter	Symbol	Test Condition	Min	Typ	Max	Unit
Static						
Gate Threshold Voltage	V _{GS(th)}	V _{DS} = V _{GS} , I _D = -250 μA	-0.6			V
Gate-Body Leakage	I _{GSS}	V _{DS} = 0 V, V _{GS} = ±12 V			±100	nA
Zero Gate Voltage Drain Current	I _{DSS}	V _{DS} = -16 V, V _{GS} = 0 V			-1	μA
		V _{DS} = -16 V, V _{GS} = 0 V, T _J = 85 °C			-5	
On-State Drain Current ^a	I _{D(on)}	V _{DS} ≤ -5 V, V _{GS} = -4.5 V	-10			A
Drain-Source On-State Resistance ^a	r _{DS(on)}	V _{GS} = -4.5 V, I _D = -2.1 A		0.130	0.155	Ω
		V _{GS} = -3.6 V, I _D = -2.0 A		0.150	0.180	
		V _{GS} = -2.5 V, I _D = -1.7 A		0.215	0.260	
Forward Transconductance ^a	g _{fs}	V _{DS} = -10 V, I _D = -2.1 A		5		S
Diode Forward Voltage ^a	V _{SD}	I _S = -0.9 A, V _{GS} = 0 V		-0.8	-1.2	V
Dynamic^b						
Total Gate Charge	Q _g	V _{DS} = -10 V, V _{GS} = -4.5 V, I _D = -2.1 A		3	6	nC
Gate-Source Charge	Q _{gs}			0.9		
Gate-Drain Charge	Q _{gd}			0.6		
Turn-On Delay Time	t _{d(on)}	V _{DD} = -10 V, R _L = 10 Ω I _D ≅ -1 A, V _{GEN} = -4.5 V, R _G = 6 Ω		13	20	ns
Rise Time	t _r			35	55	
Turn-Off Delay Time	t _{d(off)}			25	40	
Fall Time	t _f			25	40	
Source-Drain Reverse Recovery Time	t _{rr}		I _F = -0.9 A, di/dt = 100 A/μs		40	

Notes

- a. Pulse test; pulse width ≤ 300 μs, duty cycle ≤ 2%.
- b. Guaranteed by design, not subject to production testing.

TYPICAL CHARACTERISTICS (25 °C UNLESS NOTED)

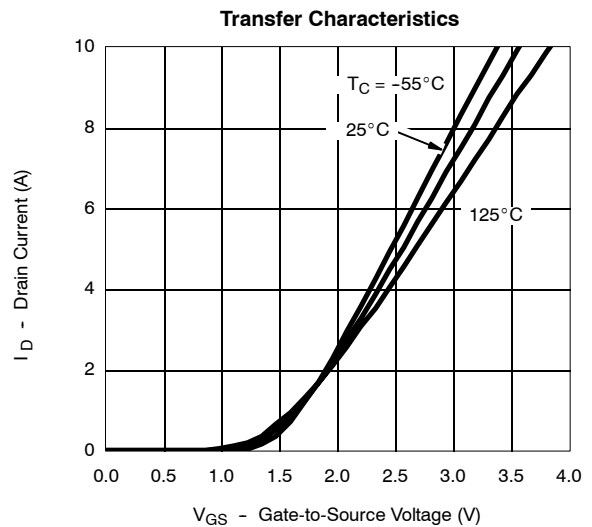
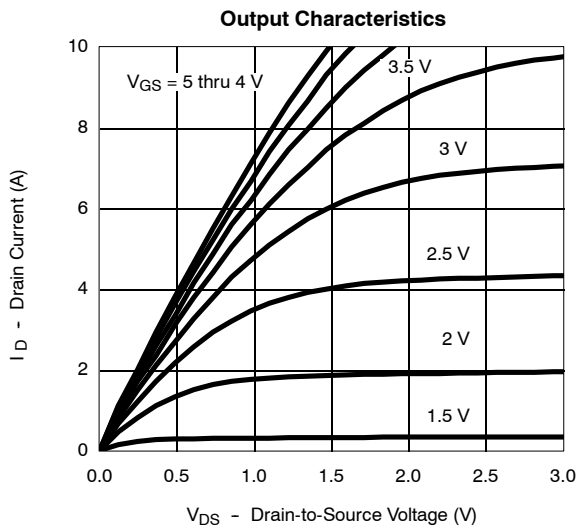



TYPICAL CHARACTERISTICS (25°C UNLESS NOTED)

On-Resistance vs. Drain Current

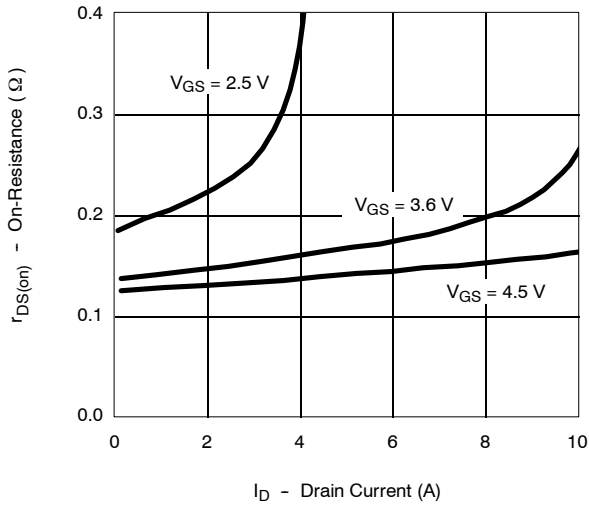

Capacitance

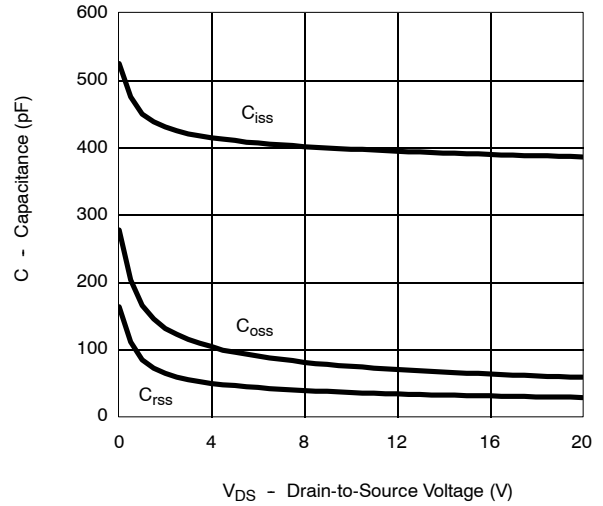

Gate Charge

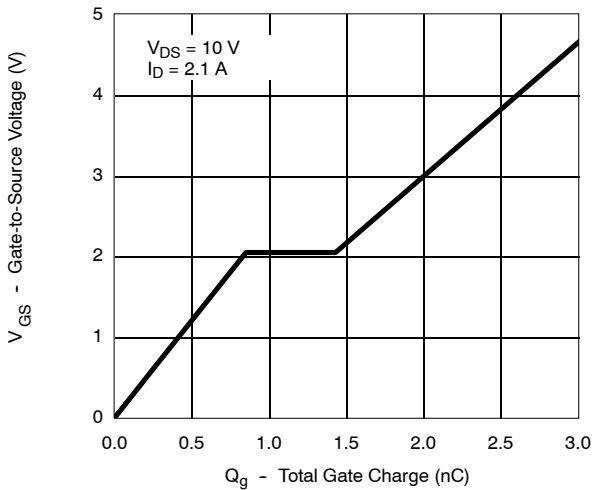

On-Resistance vs. Junction Temperature

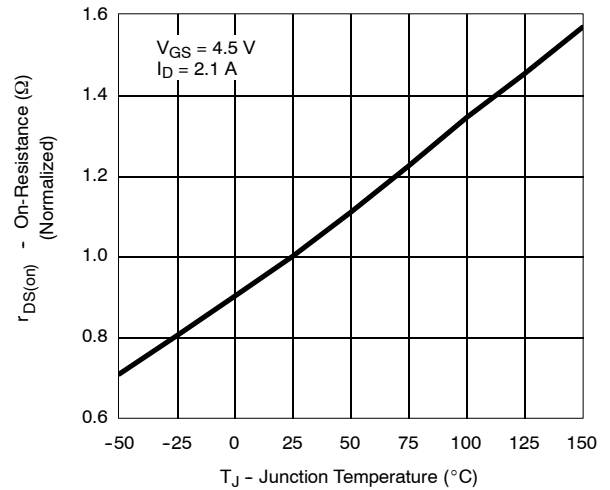

Source-Drain Diode Forward Voltage

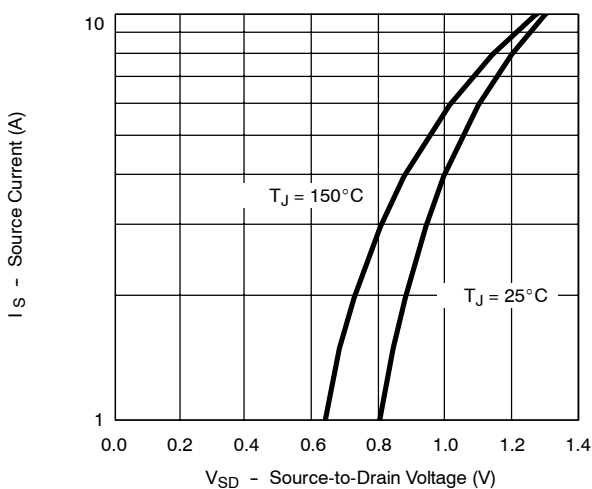

On-Resistance vs. Gate-to-Source Voltage

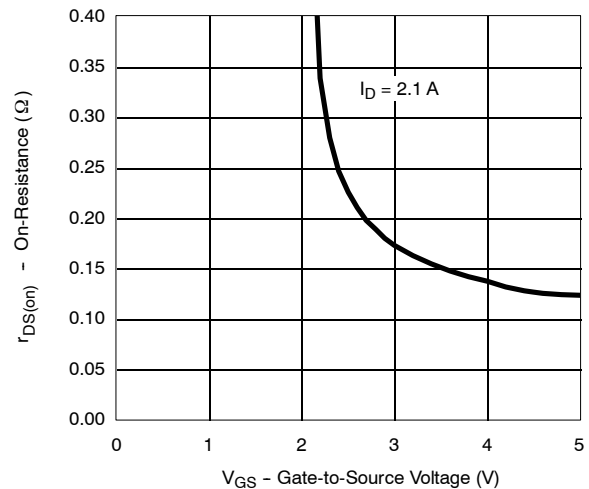

TYPICAL CHARACTERISTICS (25 °C UNLESS NOTED)

