

# DATA SHEET



## **TEF6890H**

Car radio integrated signal  
processor

Product specification

2003 Oct 21

## Car radio integrated signal processor

## TEF6890H

<b>CONTENTS</b>			
1	FEATURES	11.1	Read mode
1.1	General	11.1.1	Data byte 1; STATUS
1.2	I <sup>2</sup> C-bus	11.1.2	Data byte 2; LEVEL
1.3	Stereo decoder	11.1.3	Data byte 3; USN and WAM
1.4	Noise blanking	11.2	Write mode
1.5	Weak signal processing	11.2.1	Subaddress 2H; RDSCLK
1.6	RDS demodulator	11.2.2	Subaddress 4H; CONTROL
1.7	Tone/volume part	11.2.3	Subaddress 5H; CSALIGN
2	GENERAL DESCRIPTION	11.2.4	Subaddress 6H; MULTIPATH
3	ORDERING INFORMATION	11.2.5	Subaddress 7H; SNC
4	QUICK REFERENCE DATA	11.2.6	Subaddress 8H; HIGHCUT
5	BLOCK DIAGRAM	11.2.7	Subaddress 9H; SOFTMUTE
6	PINNING	11.2.8	Subaddress AH; RADIO
7	FUNCTIONAL DESCRIPTION	11.2.9	Subaddress BH; INPUT and ASI
7.1	Stereo decoder	11.2.10	Subaddress CH; LOUDNESS
7.2	FM and AM noise blanker	11.2.11	Subaddress DH; VOLUME
7.3	High cut control and de-emphasis	11.2.12	Subaddress EH; TREBLE
7.4	Noise detector	11.2.13	Subaddress FH; BASS
7.4.1	FM noise detector	11.2.14	Subaddress 10H; FADER
7.4.2	AM noise detector	11.2.15	Subaddress 11H; BALANCE
7.5	Multipath/weak signal processing	11.2.16	Subaddress 12H; MIX
7.6	Tone/volume control	11.2.17	Subaddress 13H; BEEP
7.6.1	Input selector	11.2.18	Subaddress 1FH; AUTOGATE
7.6.2	Loudness	12	TEST AND APPLICATION INFORMATION
7.6.3	Volume/balance	13	PACKAGE OUTLINE
7.6.4	Treble	14	SOLDERING
7.6.5	Bass	14.1	Introduction to soldering surface mount packages
7.6.6	Fader/mute	14.2	Reflow soldering
7.6.7	Beep generator and NAV input with output mixer	14.3	Wave soldering
7.7	RDS demodulator	14.4	Manual soldering
8	LIMITING VALUES	14.5	Suitability of surface mount IC packages for wave and reflow soldering methods
9	THERMAL CHARACTERISTICS	15	DATA SHEET STATUS
10	CHARACTERISTICS	16	DEFINITIONS
11	I <sup>2</sup> C-BUS PROTOCOL	17	DISCLAIMERS
		18	PURCHASE OF PHILIPS I <sup>2</sup> C COMPONENTS

# Car radio integrated signal processor

TEF6890H

## 1 FEATURES

### 1.1 General

- High integration
- No external components except coupling capacitors for signal inputs and outputs
- QFP44 package with small Printed-Circuit Board (PCB) footprint.

### 1.2 I<sup>2</sup>C-bus

- Fast mode 400 kHz I<sup>2</sup>C-bus, interfaces to logic levels ranging from 2.5 to 5 V
- Gated I<sup>2</sup>C-bus loop through to tuner IC
  - Eases PCB layout (crosstalk)
  - Allows mix of 400 kHz and 100 kHz busses
  - Low bus load reduces crosstalk
  - Buffered I/O circuit
  - Supply voltage shift between both buses allowed.
- Shortgate function offers easy control with automatic gating of a single transmission; suited for TEA684x
- Autogate function offers transparent microcontroller control with automatic on/off gating (programmable address).

### 1.3 Stereo decoder

- FM stereo decoder with high immunity to birdy noise and excellent pilot cancellation
- Integrated IF roll-off correction controlled via I<sup>2</sup>C-bus
- De-emphasis selectable between 75 and 50  $\mu$ s via I<sup>2</sup>C-bus.

### 1.4 Noise blanking

- New fully integrated AM noise blanker with excellent performance
- Fully integrated FM noise blanker with superior performance.



### 1.5 Weak signal processing

- FM weak signal processing with detectors for RF level, Ultrasonic Noise (USN) and Wideband AM (WAM) information
- AM weak signal processing with detectors for level information
- AM processing with soft mute and High Cut Control (HCC)
- FM processing with soft mute, stereo blend and HCC
- Setting of the sensitivity of the detectors and start and slope of the control functions via I<sup>2</sup>C-bus
- Weather band de-emphasis
- Level, USN and WAM read-out via I<sup>2</sup>C-bus (signal quality detectors)
- Full support of tuner AF update functions with TEA684x tuner ICs, FM audio processing holds the detectors for the FM weak signal processing in their present state during RDS updating.

### 1.6 RDS demodulator

- RDS/RBDS demodulator uses TEA684x reference frequency, no external crystal necessary.

## Car radio integrated signal processor

TEF6890H

**1.7 Tone/volume part**

- Input selector for four inputs:
  - Two external stereo inputs (CD and TAPE)
  - One mono input (PHONE)
  - One internal stereo input (AM or FM).
- Integrated tone control and audio filters without external components
- Volume control from +20 to –79 dB in 1 dB steps; programmable 20 dB loudness control included
- Programmable loudness control with bass boost or as bass and treble boost
- Treble control from –14 to +14 dB in 2 dB steps
- Bass control from –14 to +14 dB in 2 dB steps with selectable characteristics
- Good undistorted performance for any step size, including mute
- Audio Step Interpolation (ASI) available for the following audio controls:
  - Mute
  - Loudness
  - Volume/balance
  - Bass
  - Fader.
- ASI also realizes Alternative Frequency (AF) mute for inaudible RDS update
- Integrated beep generator
- Navigation (NAV) input
- Output mixer circuit for beep or NAV signal at output stages.

**2 GENERAL DESCRIPTION**

The TEF6890H is a monolithic BiMOS integrated circuit comprising the stereo decoder function, weak signal processing and ignition noise blanking facility for AM and FM combined with input selector and tone/volume control for AM and FM car radio applications. The RDS/RBDS demodulator function is included. The device operates with a supply voltage of 8 to 9 V.

**3 ORDERING INFORMATION**

TYPE NUMBER	PACKAGE		
	NAME	DESCRIPTION	VERSION
TEF6890H	QFP44	plastic quad flat package; 44 leads (lead length 1.3 mm); body 10 × 10 × 1.75 mm	SOT307-2

## Car radio integrated signal processor

TEF6890H

## 4 QUICK REFERENCE DATA

SYMBOL	PARAMETER	CONDITIONS	MIN.	TYP.	MAX.	UNIT
$V_{CC}$	supply voltage		8.0	8.5	9.0	V
$I_{CC}$	supply current	normal mode	–	28	–	mA
		standby RDS; audio on	–	24	–	mA
		standby audio; RDS on	–	19	–	mA
		standby	–	15	–	mA
<b>Stereo decoder path</b>						
$\alpha_{CS}$	channel separation	$f_{FMMPX} = 1 \text{ kHz}$	40	–	–	dB
S/N	signal-to-noise ratio	$f_{FMMPX} = 20 \text{ Hz to } 15 \text{ kHz}$	75	–	–	dB
THD	total harmonic distortion	FM mode; $f_{FMMPX} = 1 \text{ kHz}$	–	–	0.3	%
<b>Tone/volume control</b>						
$V_{i(max)(rms)}$	maximum input voltage level at pins TAPEL, TAPER, CDL, CDR, CDCM, PHONE and PHCM (RMS value)	THD = 0.1%; $G_{vol} = -6 \text{ dB}$	2	–	–	V
$V_{i(NAV)(max)(rms)}$	maximum input voltage level at pin NAV (RMS value)	THD = 1%; $f_{NAV} = 1 \text{ kHz}$	0.3	–	–	V
THD	total harmonic distortion	TAPE and CD inputs; $f_{audio} = 20 \text{ Hz to } 20 \text{ kHz}$ ; $V_i = 1 \text{ V (RMS)}$	–	0.01	0.1	%
$G_{vol}$	volume/balance gain control	maximum setting	–	20	–	dB
		minimum setting	–	–59	–	dB
$G_{step(vol)}$	step resolution gain (volume)		–	1	–	dB
$G_{loudness}$	loudness gain control	$f_{loudness(low)} = 50 \text{ Hz}$ ; high boost on maximum setting; 1 kHz tone	–	0	–	dB
		minimum setting; 1 kHz tone	–	–20	–	dB
$G_{treble}$	treble gain control	maximum setting	–	14	–	dB
		minimum setting	–	–14	–	dB
$G_{step(treble)}$	step resolution gain (treble)		–	2	–	dB
$G_{bass}$	bass gain control	maximum setting; symmetrical boost	–	14	–	dB
		minimum setting; asymmetrical cut	–	–14	–	dB
$G_{step(bass)}$	step resolution gain (bass)		–	2	–	dB

# Car radio integrated signal processor

## TEF6890H

### 5 BLOCK DIAGRAM

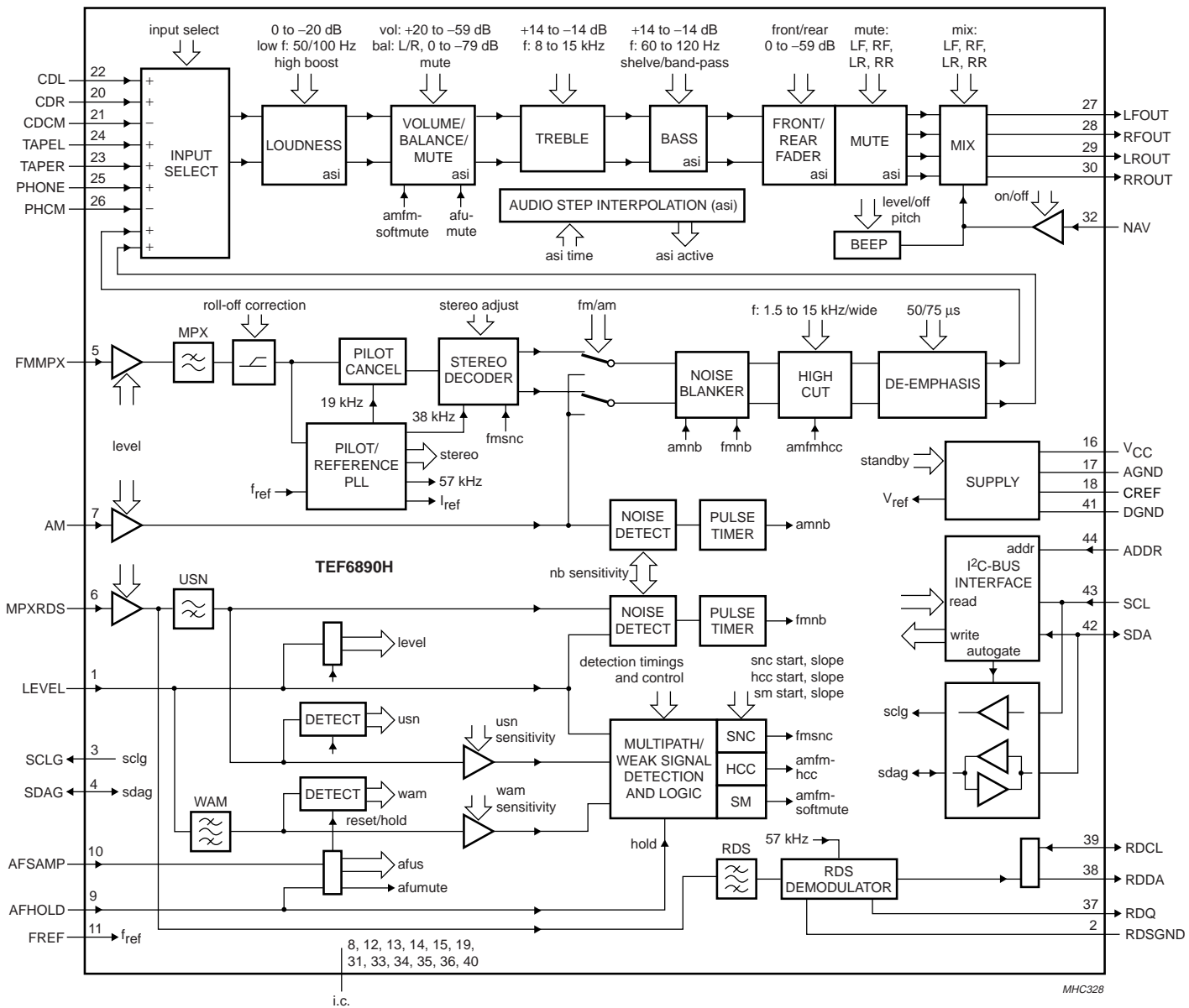

Fig.1 Block diagram.

## Car radio integrated signal processor

TEF6890H

## 6 PINNING

SYMBOL	PIN	DESCRIPTION
LEVEL	1	level detector input
RDSGND	2	RDS ground
SCLG	3	gated I <sup>2</sup> C-bus clock port
SDAG	4	gated I <sup>2</sup> C-bus data port
FMMPX	5	FM-MPX input for audio processing
MPXRDS	6	FM-MPX input for weak signal processing, noise blanker and RDS demodulator
AM	7	AM audio input
i.c.	8	internally connected
AFHOLD	9	FM weak signal processing hold input
AFSAMP	10	trigger signal input for quality measurement
FREF	11	reference frequency input 75.4 kHz
i.c.	12	internally connected
i.c.	13	internally connected
i.c.	14	internally connected
i.c.	15	internally connected
V <sub>CC</sub>	16	supply voltage
AGND	17	analog ground
CREF	18	reference voltage capacitor
i.c.	19	internally connected
CDR	20	CD right input
CDCM	21	CD common input
CDL	22	CD left input
TAPER	23	tape right input
TAPEL	24	tape left input
PHONE	25	phone input
PHCM	26	phone common input
LFOUT	27	left front output
RFOUT	28	right front output
LROUT	29	left rear output
RROUT	30	right rear output
i.c.	31	internally connected
NAV	32	audio input for navigation voice signal
i.c.	33	internally connected
i.c.	34	internally connected
i.c.	35	internally connected
i.c.	36	internally connected
RDQ	37	RDS/RBDS demodulator quality information output
RDDA	38	RDS/RBDS demodulator data output
RDCL	39	RDS/RBDS demodulator clock input or output
i.c.	40	internally connected

Car radio integrated signal processor

TEF6890H

SYMBOL	PIN	DESCRIPTION
DGND	41	digital ground
SDA	42	I <sup>2</sup> C-bus data input or output
SCL	43	I <sup>2</sup> C-bus clock input
ADDR	44	address select input

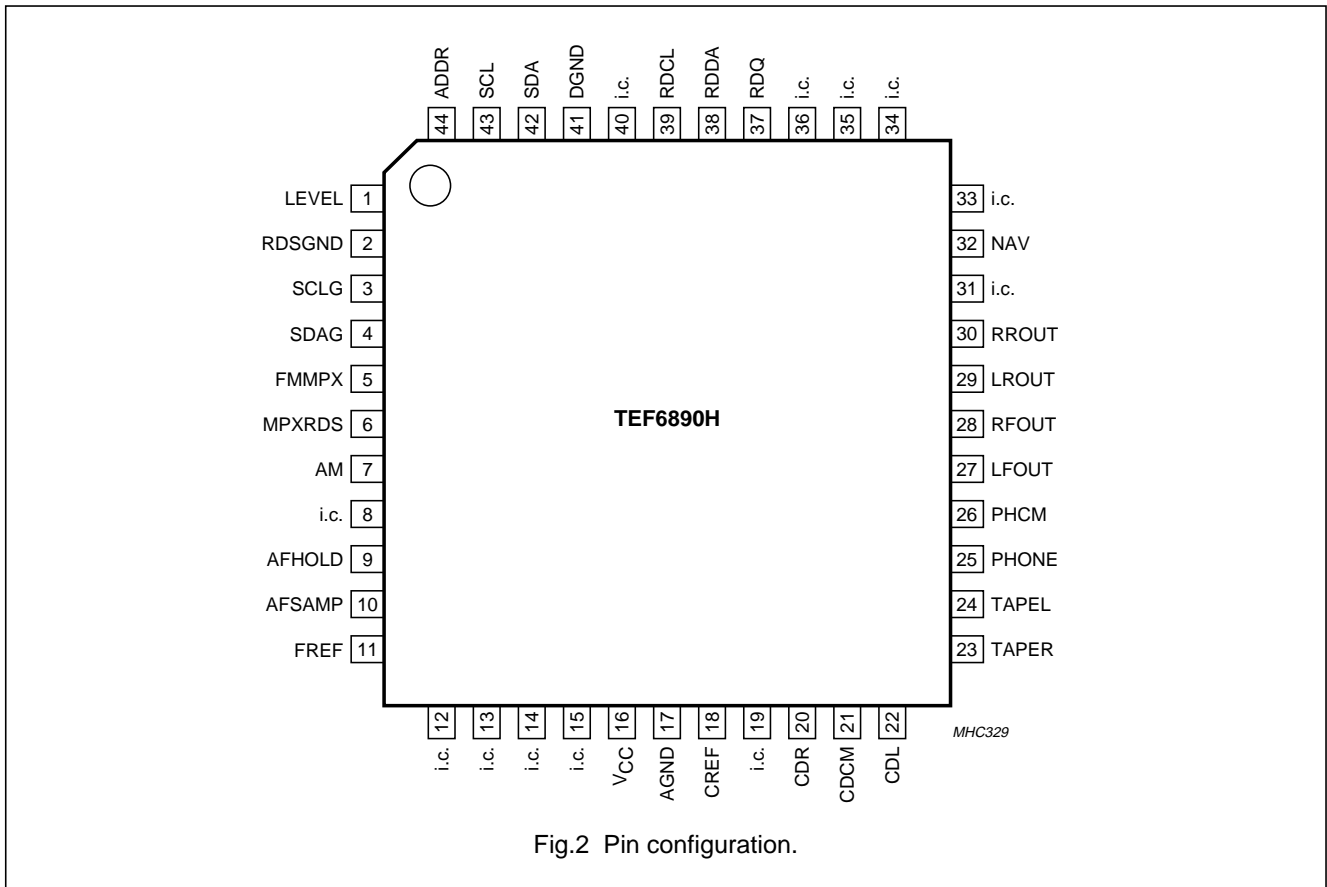

Fig.2 Pin configuration.

7 FUNCTIONAL DESCRIPTION

7.1 Stereo decoder

The FMMPX input is the input for the MPX signal from the tuner. The input gain can be selected in three settings to match the input to the RF front-end circuit. A fourth setting is used for weather band mode, which may require a gain of 23.5 dB.

A low-pass filter provides the necessary signal delay for FM noise blanking and suppression of high frequency interferences into the stereo decoder input. The output signal of this filter is fed to the roll-off correction circuit. This circuit compensates the frequency response caused by the low-pass characteristic of the tuner circuit with its IF filters. The roll-off correction circuit is adjustable in four

settings to compensate different frequency responses of the tuner part.

The MPX signal is decoded in the stereo decoder part. A PLL is used for the regeneration of the 38 kHz subcarrier. The fully integrated oscillator is adjusted by a digital auxiliary PLL into the capture range of the main PLL. The auxiliary PLL needs an external reference frequency (75.4 kHz) which is provided by the tuner ICs of the NICE family (TEA684x). The required 19 and 38 kHz signals are generated by division of the oscillator output signal in a logic circuit. The 19 kHz quadrature phase signal is fed to the 19 kHz phase detector, where it is compared with the incoming pilot tone. The DC output signal of the phase detector controls the oscillator (PLL).



## Car radio integrated signal processor

## TEF6890H

The pilot detector is driven by an internally generated in-phase 19 kHz signal. Its pilot dependent voltage activates the stereo indicator bit and sets the stereo decoder to stereo mode. The same voltage is used to control the amplitude of an anti-phase internally generated 19 kHz signal. In the pilot canceller, the pilot tone is compensated by this anti-phase 19 kHz signal.

The signal is then decoded in the decoder part. The side signal is demodulated and combined with the main signal to the left and right audio channels. A fine adjustment of the roll-off compensation is done by adjusting the gain of the L-R signal in 16 steps. A smooth mono to stereo takeover is achieved by controlling the efficiency of the matrix by the FMSNC signal from the weak signal processing block.

### 7.2 FM and AM noise blanker

The FM/AM switch selects the output signal of the stereo decoder (FM mode) or the signal from the AM input for the noise blanker block. In FM mode the noise blanker operates as a sample and hold circuit, while in AM mode it mutes the audio signal during the interference pulse. The blanking pulse which triggers the noise blanker is generated in the noise detector block.

### 7.3 High cut control and de-emphasis

The High Cut Control (HCC) part is a low-pass filter circuit with eight different static roll-off response curves. The cut-off frequencies of these filter curves can be selected by I<sup>2</sup>C-bus to match different application requirements. The HCC circuit also provides a dynamic control of the filter response. This function is controlled by the AMFMHCC signal from the weak signal processing.

The signal passes the de-emphasis block with two de-emphasis values (50 and 75  $\mu$ s), which can be selected via I<sup>2</sup>C-bus, and is fed to the input selector.

### 7.4 Noise detector

#### 7.4.1 FM NOISE DETECTOR

The trigger signal for the FM noise detector is derived from the MPXRDS input signal and the LEVEL signal. In the MPXRDS path a four pole high-pass filter (100 kHz) separates the noise spikes from the wanted MPX signal. Another detector circuit triggers on noise spikes on the level voltage. The signals of both detectors are combined to achieve a reliable trigger signal for the noise blanker. AGC circuits in the detector part control the gain depending on the average noise in the signals to prevent false triggering. The sensitivity of the triggering from the

MPXRDS signal can be adjusted in four steps, the triggering from the LEVEL signal in three steps.

#### 7.4.2 AM NOISE DETECTOR

The trigger pulse for the AM noise blanker is derived from the AM audio signal. The noise spikes are detected by a slew rate detector, which detects excessive slew rates which do not occur in normal audio signals. The sensitivity of the AM noise blanker can be adjusted in four steps.

### 7.5 Multipath/weak signal processing

The multipath (MPH)/weak signal processing block detects quality degradations in the incoming FM signal and controls the processing of the audio signal accordingly. There are three different quality criteria:

- The average value of the level voltage
- The AM components on the level voltage [Wideband AM (WAM)]
- The high frequency components in the MPX signal [Ultrasonic Noise (USN)].

The level voltage is converted to a digital value by an 8-bit analog-to-digital converter. A digital filter circuit (WAM filter) derives the wideband AM components from the level signal. The high frequency components in the MPX signals are measured with an analog-to-digital converter (USN ADC) at the output of the 100 kHz high-pass filter in the MPXRDS path.

The values of these three signals are externally available via the I<sup>2</sup>C-bus.

In the weak signal processing block the three digital signals are combined in a specific way and used for the generation of control signals for soft mute, stereo blend (stereo noise control, FMSNC) and high cut control (AMFMHCC).

The sensitivities of the detector circuits (WAM and USN) are adjustable via the I<sup>2</sup>C-bus.

Also the start values and the slopes of the control functions soft mute, stereo blend and high cut control can be set via the I<sup>2</sup>C-bus.

Soft mute, stereo blend and HCC are set on hold during the AF updating (quality check of alternative frequency) to avoid an influence of the tuning procedure on the weak signal processing conditions.

In AM mode the soft mute and high cut control are available too, the weak signal block is controlled by the average value of the level voltage.

## Car radio integrated signal processor

TEF6890H

### 7.6 Tone/volume control

The tone/volume control part consists of the following stages:

- Input selector
- Loudness control
- Volume/balance control with muting
- Treble control
- Bass control
- Fader and output mute
- Beep generator
- NAV input
- Output mixer.

The settings of all stages are controlled via the I<sup>2</sup>C-bus.

The stages input selector, loudness, volume/balance, bass, and fader/output mute include the Audio Step Interpolation (ASI) function. This minimizes pops by smoothing the transitions in the audio signal during the switching of the controls. The transition time of the ASI function is programmable by I<sup>2</sup>C-bus in four steps.

#### 7.6.1 INPUT SELECTOR

The input selector selects one of four input sources:

- Two external stereo inputs (CD and TAPE)
- One external mono input (PHONE)
- One internal stereo input (AM/FM).

#### 7.6.2 LOUDNESS

The output of the input selector is fed into the loudness circuit. Four different loudness curves can be selected via the I<sup>2</sup>C-bus. The control range is between 0 and –20 dB with a step size of 1 dB; see Figs 16 to 19.

#### 7.6.3 VOLUME/BALANCE

The volume/balance control is used for volume setting and also for balance adjustment. The control range of the volume/balance control is between +20 and –59 dB in steps of 1 dB.

The combination of loudness and volume/balance realizes an overall control range of +20 to –79 dB.

#### 7.6.4 TREBLE

The signal is then fed to the treble control stage. The control range is between +14 and –14 dB in steps of 2 dB. Figure 20 shows the control characteristic. Four different filter frequencies can be selected.

#### 7.6.5 BASS

The characteristic of the bass attenuation curves can be set to shelve or band-pass. Four different frequencies can be selected as centre frequency of the band-pass curve. Figures 21 and 22 show the bass curves with a band-pass filter frequency of 60 Hz. The control range is between +14 and –14 dB in steps of 2 dB.

#### 7.6.6 FADER/MUTE

The four fader/mute blocks are located at the end of the tone/volume chain. The control range of these attenuators is 0 to –59 dB. The step size is:

- 1 dB between 0 and –15 dB
- 2.5 dB between –15 and –45 dB
- 3 dB between –45 and –51 dB
- 4 dB between –51 and –59 dB.

#### 7.6.7 BEEP GENERATOR AND NAV INPUT WITH OUTPUT MIXER

The output mixer circuit can add an additional audio signal to any of the four outputs together with the main signal or instead of the main signal.

The additional signal can be generated internally by the beep generator with four different audio frequencies or applied to the NAV input, for instance a navigation voice signal.

### 7.7 RDS demodulator

The RDS demodulator recovers and regenerates the continuously transmitted RDS or RBDS data stream of the multiplex signal (MPXRDS) and provides the signals clock (RDCL), data (RDDA) and quality (RDQ) for external use. The RDS demodulator uses the reference frequency (75.4 kHz) from the tuner IC and does not need a crystal.

## Car radio integrated signal processor

TEF6890H

**8 LIMITING VALUES**

In accordance with the Absolute Maximum Rating System (IEC 60134).

SYMBOL	PARAMETER	CONDITIONS	MIN.	MAX.	UNIT
$V_{CC}$	supply voltage		-0.3	+10	V
$V_i$	input voltage for any pin		-0.3	$V_{CC} + 0.3$	V
$T_{stg}$	storage temperature		-65	+150	°C
$T_{amb}$	ambient temperature		-40	+85	°C
$V_{esd}$	electrostatic discharge voltage	note 1	-200	+200	V
		note 2	-2000	+2000	V

**Notes**

- Machine model ( $R = 0 \Omega$ ,  $C = 200 \text{ pF}$ ).
- Human body model ( $R = 1.5 \text{ k}\Omega$ ,  $C = 100 \text{ pF}$ ).

**9 THERMAL CHARACTERISTICS**

SYMBOL	PARAMETER	CONDITIONS	VALUE	UNIT
$R_{th(j-a)}$	thermal resistance from junction to ambient	in free air	61	K/W

**10 CHARACTERISTICS**

FM part:  $f_{FMMPX} = 1 \text{ kHz}$  at  $V_{FMMPX} = 767 \text{ mV}$  (RMS); pilot off (100% FM). AM part:  $f_{AM} = 1 \text{ kHz}$  at  $V_{AM} = 967 \text{ mV}$  (RMS) (100% AM). Treble: 10 kHz filter frequency. Bass: 60 Hz filter frequency. Loudness: 50 Hz filter frequency; treble loudness on.  $V_{CC} = 8.5 \text{ V}$ ;  $T_{amb} = 25 \text{ °C}$ ; see Fig.23; unless otherwise specified.

SYMBOL	PARAMETER	CONDITIONS	MIN.	TYP.	MAX.	UNIT
$V_{CC}$	supply voltage		8.0	8.5	9.0	V
$I_{CC}$	supply current	normal mode	-	28	-	mA
		standby RDS; audio on	-	24	-	mA
		standby audio; RDS on	-	19	-	mA
		standby	-	15	-	mA
<b>Logic pins</b>						
$V_{IH}$	HIGH-level input voltage	pins SDA, SCL, ADDR, SDAG and RDCL	1.75	-	5.5	V
		pins AFHOLD and AFSAMP	1.75	-	5.5	V
$V_{IL}$	LOW-level input voltage	pins SDA, SCL, ADDR, SDAG and RDCL	-0.2	-	+1.0	V
		pins AFHOLD and AFSAMP	-0.2	-	+1.0	V
$V_{OH}$	HIGH-level output voltage	pins RDCL and RDDA; $I_{OH} = 2.5 \mu\text{A}$	2.6	-	-	V
$V_{OL}$	LOW-level output voltage	pins SCLG, RDCL and RDDA; $I_{OL} = 3 \text{ mA}$ ; note 1	-	-	0.4	V
		pin SDA; $I_{OL} = 3 \text{ mA}$	-	-	0.4	V

## Car radio integrated signal processor

## TEF6890H

SYMBOL	PARAMETER	CONDITIONS	MIN.	TYP.	MAX.	UNIT
<b>Stereo decoder and AM path</b>						
$V_{o(FM)(rms)}$	FM mono output voltage (RMS value) on pins LFOUT and RFOUT	$f_{FMMPX} = 1 \text{ kHz}$ ; 91% FM modulation without pilot ( $V_{FMMPX} = 698 \text{ mV}$ )	750	950	1200	mV
$V_{o(AM)(rms)}$	AM output voltage (RMS value) on pins LFOUT and RFOUT	$f_{AM} = 1 \text{ kHz}$ ; $V_{AM} = 870 \text{ mV}$ ; 90% AM modulation	800	1080	1360	mV
$G_i$	input gain on pins FMMPX, MPXRDS and AM	see Table 37 ING[1:0] = 00; all inputs ING[1:0] = 01; all inputs ING[1:0] = 10; all inputs ING[1:0] = 11; FMMPX ING[1:0] = 11; MPXRDS and AM	–	0 3 6 23.5 0	–	dB dB dB dB dB
$\alpha_{cs}$	channel separation	$f_{FMMPX} = 1 \text{ kHz}$	40	–	–	dB
$g_{c(L-R)}$	roll-off correction for coarse adjustment of separation	see Table 21; measure 1 kHz level for L – R modulation; compare to 1 kHz level for L + R modulation CSR[1:0] = 00 CSR[1:0] = 01 CSR[1:0] = 10 CSR[1:0] = 11	–	0 0.4 0.8 1.2	–	dB dB dB dB
$g_{f(L-R)}$	stereo adjust for fine adjustment of separation	see Table 22; measure 1 kHz level for L – R modulation; compare to 1 kHz level for L + R modulation CSA[3:0] = 0000 CSA[3:0] = 0001 : CSA[3:0] = 1110 CSA[3:0] = 1111	–	0 0.2 : 2.8 3.0	–	dB dB dB dB dB
S/N	signal-to-noise ratio	$f_{FMMPX} = 20 \text{ Hz to } 15 \text{ kHz}$ ; referenced to 1 kHz at 91% FM modulation; DEMP = 1 ( $\tau_{de-em} = 50 \mu\text{s}$ )	75	–	–	dB
THD	total harmonic distortion	FM mode $f_{FMMPX} = 1 \text{ kHz}$ $V_{FMMPX} = 50\%$ ; L; pilot on $V_{FMMPX} = 50\%$ ; R; pilot on	–	–	0.3 0.3 0.3	% % %
$V_{o(bal)}$	mono channel balance $\frac{V_{oL}}{V_{oR}}$	FM mode	–1	–	+1	dB
$\alpha_{19}$	pilot signal suppression	9% pilot; $f_{pilot} = 19 \text{ kHz}$ ; referenced to 1 kHz at 91% FM modulation; DEMP = 1 ( $\tau_{de-em} = 50 \mu\text{s}$ )	40	50	–	dB

## Car radio integrated signal processor

## TEF6890H

SYMBOL	PARAMETER	CONDITIONS	MIN.	TYP.	MAX.	UNIT
$\alpha$	subcarrier suppression	modulation off; referenced to 1 kHz at 91% FM modulation				
		$f_{sc} = 38$ kHz	35	50	–	dB
		$f_{sc} = 57$ kHz	40	–	–	dB
		$f_{sc} = 76$ kHz	50	60	–	dB
PSRR	power supply ripple rejection	FM mode; $f_{ripple} = 100$ Hz; $V_{CC(AC)} = V_{ripple} = 100$ mV (RMS)	24	–	–	dB
$\Delta V_{out}$	frequency response	FM mode				
		$f_{FMMPX} = 20$ Hz	–0.5	–	+0.5	dB
		$f_{FMMPX} = 15$ kHz	–0.5	–	+0.5	dB
$f_{cut-off(de-em)}$	cut-off frequency of de-emphasis filter	–3 dB point; see Fig.15				
		DEMP = 1 ( $\tau_{de-em} = 50$ $\mu$ s)	–	3.18	–	kHz
		DEMP = 0 ( $\tau_{de-em} = 75$ $\mu$ s)	–	2.12	–	kHz
$m_{i(pilot)(rms)}$	pilot threshold modulation for automatic switching by pilot input voltage (RMS value)	stereo				
		on	–	4.0	5.5	%
		off	1.3	2.7	–	%
$hys_{pilot}$	hysteresis of pilot threshold voltage		–	2	–	dB
$V_{ref(min)}$	minimum reference input voltage		–	–	30	mV
$f_{ref}$	reference frequency for stereo PLL and RDS demodulator		75361	75368	75375	Hz
<b>Noise blanker</b>						
FM PART						
$t_{sup(min)}$	minimum suppression time		–	15	–	$\mu$ s
$V_{MPXRDS(M)}$	noise blanker sensitivity at MPXRDS input (peak value of noise pulses)	see Table 38; $t_{pulse} = 10$ $\mu$ s; $f_{pulse} = 300$ Hz				
		NBS[1:0] = 00	–	90	–	mV
		NBS[1:0] = 01	–	150	–	mV
		NBS[1:0] = 10	–	210	–	mV
		NBS[1:0] = 11	–	270	–	mV
$V_{LEVEL(M)}$	noise blanker sensitivity at LEVEL input (peak value of noise pulses)	see Table 41; $t_{pulse} = 10$ $\mu$ s; $f_{pulse} = 300$ Hz				
		NBL[1:0] = 00	–	9	–	mV
		NBL[1:0] = 01	–	18	–	mV
		NBL[1:0] = 10	–	28	–	mV

## Car radio integrated signal processor

TEF6890H

SYMBOL	PARAMETER	CONDITIONS	MIN.	TYP.	MAX.	UNIT
<b>AM PART</b>						
$t_{\text{sup(min)}}$	minimum suppression time		–	200	–	$\mu\text{s}$
$M_{\text{AM}}$	noise blanker sensitivity	see Table 38; $f_{\text{audio}} = 2 \text{ kHz}$ NBS[1:0] = 00 NBS[1:0] = 01 NBS[1:0] = 10 NBS[1:0] = 11	– – – –	110 140 175 220	– – – –	% % % %
<b>Weak signal processing</b>						
<b>DETECTORS</b>						
$V_{\text{eq(USN)}}$	USN sensitivity equivalent level voltage	see Fig.5; $f_{\text{MPXRDS}} = 150 \text{ kHz}$ ; $V_{\text{MPXRDS}} = 250 \text{ mV (RMS)}$ ; HCMP = 1; note 2 USS[1:0] = 00 USS[1:0] = 01 USS[1:0] = 10 USS[1:0] = 11	– – – –	2.5 2 1.5 0.5	– – – –	V V V V
$V_{\text{eq(WAM)}}$	WAM sensitivity equivalent level voltage	see Fig.6; $V_{\text{LEVEL}} = 200 \text{ mV (p-p)}$ at $f = 21 \text{ kHz}$ on the level voltage; HCMP = 1; note 2 WAS[1:0] = 00 WAS[1:0] = 01 WAS[1:0] = 10 WAS[1:0] = 11	– – – –	2.5 2 1.5 0.5	– – – –	V V V V
$t_{\text{LEVEL(attack)}}$	level detector attack time (soft mute and HCC)	see Table 25; LETF = 0; SEAR = 0 LET[1:0] = 00 LET[1:0] = 01 LET[1:0] = 10 LET[1:0] = 11 see Table 25; LETF = 1; SEAR = 0 LET[1:0] = 00 LET[1:0] = 01 LET[1:0] = 10 LET[1:0] = 11 search mode; SEAR = 1	– – – – – – – – –	3 3 1.5 0.5 0.5 0.17 0.06 0.06 60	– – – – – – – – –	s s s s s s s s ms

## Car radio integrated signal processor

## TEF6890H

SYMBOL	PARAMETER	CONDITIONS	MIN.	TYP.	MAX.	UNIT	
$t_{\text{LEVEL(decay)}}$	level detector decay time (soft mute and HCC)	see Table 25; LETF = 0; SEAR = 0					
		LET[1:0] = 00	–	3	–	s	
		LET[1:0] = 01	–	6	–	s	
		LET[1:0] = 10	–	1.5	–	s	
		LET[1:0] = 11	–	1.5	–	s	
		see Table 25; LETF = 1; SEAR = 0					
		LET[1:0] = 00	–	0.5	–	s	
		LET[1:0] = 01	–	0.5	–	s	
LET[1:0] = 10	–	0.17	–	s			
LET[1:0] = 11	–	0.06	–	s			
		search mode; SEAR = 1	–	60	–	ms	
$t_{\text{MPH(attack)}}$	multipath detector attack time (SNC)	see Table 26; SEAR = 0					
		MPT[1:0] = 00	–	0.5	–	s	
		MPT[1:0] = 01	–	0.5	–	s	
		MPT[1:0] = 10	–	0.5	–	s	
		MPT[1:0] = 11	–	0.25	–	s	
		search mode; SEAR = 1	–	60	–	ms	
$t_{\text{MPH(decay)}}$	multipath detector decay time (SNC)	see Table 26; SEAR = 0					
		MPT[1:0] = 00	–	12	–	s	
		MPT[1:0] = 01	–	24	–	s	
		MPT[1:0] = 10	–	6	–	s	
		MPT[1:0] = 11	–	6	–	s	
		search mode; SEAR = 1	–	60	–	ms	
$t_{\text{USN(attack)}}$	USN detector attack time (soft mute and SNC)		–	1	–	ms	
$t_{\text{USN(decay)}}$	USN detector decay time (soft mute and SNC)		–	1	–	ms	
$\Delta\text{USS}$	USN detector desensitization	USN sensitivity setting (USS) versus level voltage (USN sensitivity setting is automatically reduced as level voltage decreases)					
		$V_{\text{LEVEL}} > 1.25 \text{ V}$	–	–	3	–	
		$1.25 \text{ V} > V_{\text{LEVEL}} > 1.125 \text{ V}$	–	–	2	–	
		$1.125 \text{ V} > V_{\text{LEVEL}} > 1.0 \text{ V}$	–	–	1	–	
		$1.0 \text{ V} > V_{\text{LEVEL}}$	–	–	0	–	
$t_{\text{WAM(attack)}}$	WAM detector attack time (SNC)		–	1	–	ms	
$t_{\text{WAM(decay)}}$	WAM detector decay time (SNC)		–	1	–	ms	
$t_{\text{peak(USN)(attack)}}$	peak detector for USN attack time for read-out via I <sup>2</sup> C-bus		–	1	–	ms	

## Car radio integrated signal processor

TEF6890H

SYMBOL	PARAMETER	CONDITIONS	MIN.	TYP.	MAX.	UNIT
$t_{\text{peak(USN)(decay)}}$	peak detector for USN decay time for read-out via I <sup>2</sup> C-bus		–	10	–	ms
$t_{\text{peak(WAM)(attack)}}$	peak detector for WAM attack time for read-out via I <sup>2</sup> C-bus		–	1	–	ms
$t_{\text{peak(WAM)(decay)}}$	peak detector for WAM decay time for read-out via I <sup>2</sup> C-bus		–	10	–	ms
<b>CONTROL FUNCTIONS</b>						
$V_{\text{start(mute)}}$	soft mute start voltage	see Fig.12; voltage at pin LEVEL that causes $\alpha_{\text{mute}} = 3 \text{ dB}$ ; MSL[1:0] = 11 MST[2:0] = 000 MST[2:0] = 001 MST[2:0] = 010 MST[2:0] = 011 MST[2:0] = 100 MST[2:0] = 101 MST[2:0] = 110 MST[2:0] = 111	– – – – – – – –	0.75 0.88 1 1.12 1.25 1.5 1.75 2	– – – – – – – –	V V V V V V V V
$C_{\text{mute}}$	soft mute slope $C_{\text{mute}} = \frac{\Delta\alpha_{\text{mute}}}{\Delta V_{\text{eq}}}$	see Fig.13; slope of soft mute attenuation with respect to level voltage; MST[2:0] = 000 MSL[1:0] = 00 MSL[1:0] = 01 MSL[1:0] = 10 MSL[1:0] = 11	– – – –	8 16 24 32	– – – –	dB/V dB/V dB/V dB/V
$\alpha_{\text{mute(max)}}$	maximum soft mute attenuation by USN	see Fig.14; $f_{\text{MPXRDS}} = 150 \text{ kHz}$ ; $V_{\text{MPXRDS}} = 0.6 \text{ V (RMS)}$ ; USS[1:0] = 11 UMD[1:0] = 00 UMD[1:0] = 01 UMD[1:0] = 10 UMD[1:0] = 11	– – – –	3 6 9 12	– – – –	dB dB dB dB
$V_{\text{start(SNC)}}$	SNC stereo blend start voltage	see Fig.7; voltage at pin LEVEL that causes channel separation = 10 dB; SSL[1:0] = 10 SST[3:0] = 0000 : SST[3:0] = 1000 : SST[3:0] = 1111	– – – – –	1.5 : 2.0 : 2.45	– – – – –	V V V V V



Car radio integrated signal processor

TEF6890H

SYMBOL	PARAMETER	CONDITIONS	MIN.	TYP.	MAX.	UNIT
C <sub>SNC</sub>	SNC slope $C_{SNC} = \frac{\Delta\alpha_{cs}}{\Delta V_{eq}}$	see Fig.8; slope of channel separation between 30 dB and 10 dB with respect to level voltage; SST[3:0] = 1010				
		SSL[1:0] = 00	–	38	–	dB/V
		SSL[1:0] = 01	–	51	–	dB/V
		SSL[1:0] = 10	–	63	–	dB/V
		SSL[1:0] = 11	–	72	–	dB/V
V <sub>start(HCC)</sub>	HCC start voltage	see Fig.9; f <sub>audio</sub> = 10 kHz; voltage at pin LEVEL that causes α <sub>HCC</sub> = 3 dB; HSL[1:0] = 10				
		HST[2:0] = 000	–	1.17	–	V
		HST[2:0] = 001	–	1.42	–	V
		HST[2:0] = 010	–	1.67	–	V
		HST[2:0] = 011	–	1.92	–	V
		HST[2:0] = 100	–	2.17	–	V
		HST[2:0] = 101	–	2.67	–	V
		HST[2:0] = 110	–	3.17	–	V
		HST[2:0] = 111	–	3.67	–	V
C <sub>HCC</sub>	HCC slope $C_{HCC} = \frac{\Delta\alpha_{HCC}}{\Delta V_{eq}}$	see Fig.10; f <sub>audio</sub> = 10 kHz; HST[2:0] = 010				
		HSL[1:0] = 00	–	9	–	dB/V
		HSL[1:0] = 01	–	11	–	dB/V
		HSL[1:0] = 10	–	14	–	dB/V
		HSL[1:0] = 11	–	18	–	dB/V
α <sub>HCC(max)</sub>	maximum HCC attenuation	see Fig.10; f <sub>audio</sub> = 10 kHz				
		HCSF = 1	–	10	–	dB
		HCSF = 0	–	14	–	dB
f <sub>cut-off</sub>	cut-off frequency of fixed HCC	see Table 32; –3 dB point (first order filter)				
		HCF[2:0] = 000	–	1.5	–	kHz
		HCF[2:0] = 001	–	2.2	–	kHz
		HCF[2:0] = 010	–	3.3	–	kHz
		HCF[2:0] = 011	–	4.7	–	kHz
		HCF[2:0] = 100	–	6.8	–	kHz
		HCF[2:0] = 101	–	10	–	kHz
		HCF[2:0] = 110	–	wide	–	–
		HCF[2:0] = 111	–	unlimited	–	–
<b>Analog-to-digital converters for I<sup>2</sup>C-bus</b>						
LEVEL ANALOG-TO-DIGITAL CONVERTER (8-BIT); see Fig.4						
V <sub>LEVEL(min)</sub>	lower voltage limit of conversion range		–	0.25	–	V

## Car radio integrated signal processor

## TEF6890H

SYMBOL	PARAMETER	CONDITIONS	MIN.	TYP.	MAX.	UNIT
$V_{LEVEL(max)}$	upper voltage limit of conversion range		–	4.25	–	V
$\Delta V_{LEVEL}$	bit resolution voltage		–	15.7	–	mV
<b>ULTRASONIC NOISE ANALOG-TO-DIGITAL CONVERTER (4-BIT); see Fig.5</b>						
$V_{USN(min)(rms)}$	conversion range lower voltage limit (RMS value)	$f_{FMMPX} = 150 \text{ kHz}$	–	0	–	V
$V_{USN(max)(rms)}$	conversion range upper voltage limit (RMS value)	$f_{FMMPX} = 150 \text{ kHz}$	–	0.75	–	V
$\Delta V_{USN(rms)}$	bit resolution voltage (RMS value)		–	50	–	mV
<b>WIDEBAND AM ANALOG-TO-DIGITAL CONVERTER (4-BIT); see Fig.6</b>						
$V_{WAM(min)(p-p)}$	lower voltage limit of conversion range (peak-to-peak value)	$f_{LEVEL} = 21 \text{ kHz}$	–	0	–	mV
$V_{WAM(max)(p-p)}$	upper voltage limit of conversion range (peak-to-peak value)	$f_{LEVEL} = 21 \text{ kHz}$	–	800	–	mV
$\Delta V_{WAM(p-p)}$	bit resolution voltage (peak-to-peak value)		–	53.3	–	mV
<b>Tone/volume control</b>						
$Z_i$	input impedance at pins TAPEL, TAPER, CDL and CDR		80	–	–	$k\Omega$
	input impedance at pin PHONE		50	–	–	$k\Omega$
$Z_o$	output impedance at pins LFOUT, RFOUT, LROUT and RROUT		–	–	100	$\Omega$
$G_{s(main)}$	signal gain from main source input to LFOUT, RFOUT, LROUT and RROUT outputs		–1	–	+1	dB
$G_{s(NAV)}$	signal gain from NAV input to LFOUT, RFOUT, LROUT and RROUT outputs		–1.5	0	+1.5	dB
$V_{i(max)(rms)}$	maximum input voltage level at pins TAPEL, TAPER, CDL, CDR and PHONE (RMS value)	THD = 0.1%; $G_{vol} = -6 \text{ dB}$	2	–	–	V
$V_{i(NAV)(max)(rms)}$	maximum input voltage level at pin NAV (RMS value)	THD = 1%	0.3	–	–	V

## Car radio integrated signal processor

## TEF6890H

SYMBOL	PARAMETER	CONDITIONS	MIN.	TYP.	MAX.	UNIT
$V_{o(max)(rms)}$	maximum output voltage (RMS value)	THD = 0.1%; $G_{vol} = +6$ dB	2	–	–	V
		worst case load: $R_L = 2$ k $\Omega$ , $C_L = 10$ nF, THD = 1%	2	–	–	V
$f_{max}$	frequency response (pins TAPER, TAPEL, CDR and CDL)	upper –0.5 dB point; referenced to 1 kHz	20	–	–	kHz
CMRR	common mode rejection ratio	$f_{audio} = 20$ Hz to 20 kHz on CD and PHONE inputs				
		$G_{vol} = 0$ dB	40	–	–	dB
		$G_{vol} = -15$ dB	55	–	–	dB
$\alpha_{cs}$	channel separation	$f_{audio} = 20$ Hz to 20 kHz	60	80	–	dB
$\alpha_S$	input isolation of one selected source to any other input	$f_{audio} = 1$ kHz	90	105	–	dB
		$f_{audio} = 20$ Hz to 10 kHz	75	90	–	dB
		$f_{audio} = 20$ kHz	70	–	–	dB
THD	total harmonic distortion	TAPE and CD inputs				
		$f_{audio} = 20$ Hz to 10 kHz; $V_i = 1$ V (RMS)	–	0.01	0.1	%
		$f_{audio} = 1$ kHz; $V_i = 2$ V (RMS); $G_{vol} = 0$ dB	–	0.02	0.1	%
		$f_{audio} = 20$ Hz to 10 kHz; $V_i = 2$ V (RMS); $G_{vol} = -10$ dB	–	0.02	0.2	%
		$f_{audio} = 25$ Hz; $V_i = 500$ mV (RMS); $G_{bass} = +8$ dB; $G_{vol} = 0$ dB	–	0.05	0.2	%
		$f_{audio} = 4$ kHz; $V_i = 500$ mV (RMS); $G_{treble} = +8$ dB; $G_{vol} = 0$ dB	–	0.01	0.2	%
		NAV input; $f_{audio} = 1$ kHz; $V_o = 300$ mV (RMS)	–	–	1	%
$V_{noise(rms)}$	noise voltage (RMS value)	CCIR-ARM weighted and 20 kHz 'brick wall' without input signal and shorted AF inputs				
		$G_{vol} = 0$ dB	–	12	20	$\mu$ V
		$G_{bass} = +6$ dB; $G_{treble} = +6$ dB; $G_{vol} = 0$ dB	–	24	35	$\mu$ V
		$G_{vol} = 20$ dB; TAPE input (stereo)	–	71	100	$\mu$ V
		$G_{vol} = 20$ dB; CD input (quasi-differential)	–	100	140	$\mu$ V
		$G_{vol} = -10$ dB	–	10	18	$\mu$ V
		$G_{vol} = -40$ dB; $G_{loudness} = -20$ dB	–	9.5	13.5	$\mu$ V
		outputs muted	–	5	12	$\mu$ V
		using 'A-weighting' filter and 20 kHz 'brick wall'; $G_{vol} = -10$ dB; $G_{loudness} = -10$ dB	–	6.8	10	$\mu$ V
		NAV input	–	16	40	$\mu$ V

## Car radio integrated signal processor

## TEF6890H

SYMBOL	PARAMETER	CONDITIONS	MIN.	TYP.	MAX.	UNIT	
$\Delta G_{\text{step}}$	step error (all controls) between all adjoining steps, all outputs	G = +20 to -36 dB	-	-	0.5	dB	
		G = -36 to -59 dB	-	-	1.0	dB	
$T_{\text{CASI}}$	ASI time constant (switching time from any setting to any other setting)	see Table 43	-	1	-	ms	
		AST[1:0] = 00	-	3	-	ms	
		AST[1:0] = 01	-	10	-	ms	
		AST[1:0] = 10	-	30	-	ms	
$V_{\text{offset(max)}}$	maximum DC offset	between any two settings (non-consecutive) on any one audio control or any one dynamic weak signal processing control	-	7	-	mV	
		power supply ripple rejection	$V_{\text{CC(AC)}} = V_{\text{ripple}} = 200 \text{ mV (RMS)}$	35	46	-	dB
			$f_{\text{ripple}} = 20 \text{ to } 100 \text{ Hz}$	50	75	-	dB
			$f_{\text{ripple}} = 1 \text{ kHz}$	50	65	-	dB
$\alpha_{\text{ct}}$	crosstalk between bus inputs and signal outputs	$f_{\text{clk}} = 100 \text{ kHz}$ ; note 3	-	110	-	dB	
		$t_{\text{turn-on}}$	turn-on time from $V_{\text{CC}}$ applied to 66% final DC voltage at outputs	-	100	-	ms
LOUDNESS							
$f_{\text{loudness(low)}}$	loudness low boost frequency; without influence of coupling capacitors	amplitude decrease = -3 dB	-	50	-	Hz	
		LLF = 0	-	100	-	Hz	
$f_{\text{loudness(high)}}$	loudness filter response; without influence of coupling capacitors	amplitude decrease = -1 dB; frequency referred to 100 kHz; high boost on	-	10	-	kHz	
		$G_{\text{loudness}}$	loudness gain control	$f_{\text{loudness(low)}} = 50 \text{ Hz}$ ; high boost on; see Fig.16	-	0	-
$G_{\text{loudness}}$	loudness gain control	maximum setting; 1 kHz tone	-	-20	-	dB	
		minimum setting; 1 kHz tone	-	-3	-	dB	
		minimum setting; 50 Hz tone	-	-16	-	dB	
		minimum setting; 10 kHz tone	-	-15	-	dB	
		minimum setting; 100 kHz tone	-	1	-	dB	
$G_{\text{vol}}$	volume/balance gain control	step size; 1 kHz tone	-	20	-	dB	
		see Table 49	-	-59	-	dB	
$G_{\text{vol}}$	volume/balance gain control	mute attenuation; 20 Hz to 20 kHz input	-	-80	-70	dB	
			-				
VOLUME							
$G_{\text{vol}}$	volume/balance gain control	see Table 49	-	20	-	dB	
		maximum setting	-	-59	-	dB	
$G_{\text{vol}}$	volume/balance gain control	minimum setting	-	-80	-70	dB	
		mute attenuation; 20 Hz to 20 kHz input	-				

## Car radio integrated signal processor

## TEF6890H

SYMBOL	PARAMETER	CONDITIONS	MIN.	TYP.	MAX.	UNIT
$G_{\text{step(vol)}}$	step resolution gain (volume)	see Table 49	–	1	–	dB
$\Delta G_{\text{set}}$	gain set error	$G_{\text{vol}} = +20$ to $-36$ dB	–1	0	+1	dB
		$G_{\text{vol}} = -36$ to $-59$ dB	–3	0	+3	dB
$\Delta G_{\text{track}}$	gain tracking error between left and right	$G_{\text{vol}} = +20$ to $-36$ dB	–	0	1	dB
		$G_{\text{vol}} = -36$ to $-59$ dB	–	0	3	dB
TREBLE						
$f_{\text{cut-off(treble)}}$	treble control filter cut-off frequency	see Table 53; $-3$ dB frequency referred to 100 kHz				
		TRF[1:0] = 00	–	8	–	kHz
		TRF[1:0] = 01	–	10	–	kHz
		TRF[1:0] = 10	–	12	–	kHz
		TRF[1:0] = 11	–	15	–	kHz
$G_{\text{treble}}$	treble gain control	see Table 52				
		maximum setting	–	14	–	dB
		minimum setting	–	–14	–	dB
$G_{\text{step(treble)}}$	step resolution gain (treble)	see Table 52	–	2	–	dB
BASS						
$f_{\text{c(bass)}}$	bass control filter centre frequency	see Table 57				
		BAF[1:0] = 00	–	60	–	Hz
		BAF[1:0] = 01	–	80	–	Hz
		BAF[1:0] = 10	–	100	–	Hz
		BAF[1:0] = 11	–	120	–	Hz
$Q_{\text{bass}}$	bass filter quality factor	$G_{\text{bass}} = +12$ dB	–	1.0	–	–
$EQ_{\text{bow}}$	equalizer bowing	$f_{\text{audio}} = 1$ kHz; $V_i = 500$ mV (RMS); $G_{\text{bass}} = +12$ dB; $f_{\text{c(bass)}} = 60$ Hz; $G_{\text{treble}} = +12$ dB; $f_{\text{cut-off(treble)}} = 10$ kHz; see Fig.3	–	1.8	–	dB
$G_{\text{bass}}$	bass gain control	see Table 56				
		maximum setting; symmetrical boost	–	14	–	dB
		minimum setting; asymmetrical cut	–	–14	–	dB
		minimum setting; symmetrical cut	–	–14	–	dB
$G_{\text{step(bass)}}$	step resolution gain (bass)	see Table 56	–	2	–	dB
FADER						
$G_{\text{fader}}$	fader gain control	see Table 60				
		maximum setting	–	0	–	dB
		minimum setting	–	–59	–	dB
		mute attenuation; 20 Hz to 20 kHz input	–	–80	–66	dB

## Car radio integrated signal processor

## TEF6890H

SYMBOL	PARAMETER	CONDITIONS	MIN.	TYP.	MAX.	UNIT
$G_{\text{step(fader)}}$	step resolution gain (fader)	see Table 60				
		$G_{\text{fader}} = 0$ to $-15$ dB	–	1	–	dB
		$G_{\text{fader}} = -15$ to $-45$ dB	–	2.5	–	dB
		$G_{\text{fader}} = -45$ to $-51$ dB	–	3	–	dB
		$G_{\text{fader}} = -51$ to $-59$ dB	–	4	–	dB
$\alpha_{\text{mute}}$	audio mute	volume control: mute and output muted (bits MULF, MURF, MULR and MURR)	90	–	–	dB
<b>BEEP</b>						
$f_{\text{beep}}$	beep generator frequency	see Table 69				
		BEF[1:0] = 00	–	500	–	Hz
		BEF[1:0] = 01	–	1	–	kHz
		BEF[1:0] = 10	–	2	–	kHz
		BEF[1:0] = 11	–	3	–	kHz
$V_{\text{beep(rms)}}$	beep generator audio level (RMS value)	see Table 68				
		BEL[2:0] = 000	–	0	–	mV
		BEL[2:0] = 001	–	13.3	–	mV
		BEL[2:0] = 010	–	18	–	mV
		BEL[2:0] = 011	–	28	–	mV
		BEL[2:0] = 100	–	44	–	mV
		BEL[2:0] = 101	–	60	–	mV
BEL[2:0] = 110	–	90	–	mV		
		BEL[2:0] = 111	–	150	–	mV
$\text{THD}_{\text{beep}}$	total harmonic distortion of beep generator	$f_{\text{beep}} = 1$ kHz or 2 kHz	–	–	7	%
<b>Power-on reset (all registers in default setting, outputs muted, standby mode)</b>						
$V_{\text{th(POR)}}$	threshold voltage of Power-on reset		–	6.3	–	V

**Notes**

- The LOW voltage of pin SCLG is influenced by  $V_{\text{SCL}}$ :  $V_{\text{SCLG(LOW)}} \geq V_{\text{SCL(LOW)}} + 0.22$  V.
- The equivalent level voltage is that value of the level voltage (at pin LEVEL) which results in the same weak signal control effect (for instance HCC roll-off) as the output value of the specified detector (USN, WAM and MPH).
- Crosstalk between bus inputs and signal outputs:  $\alpha_{\text{ct}} = 20 \log \frac{V_{\text{bus(p-p)}}}{V_{\text{o(rms)}}$

Car radio integrated signal processor

TEF6890H

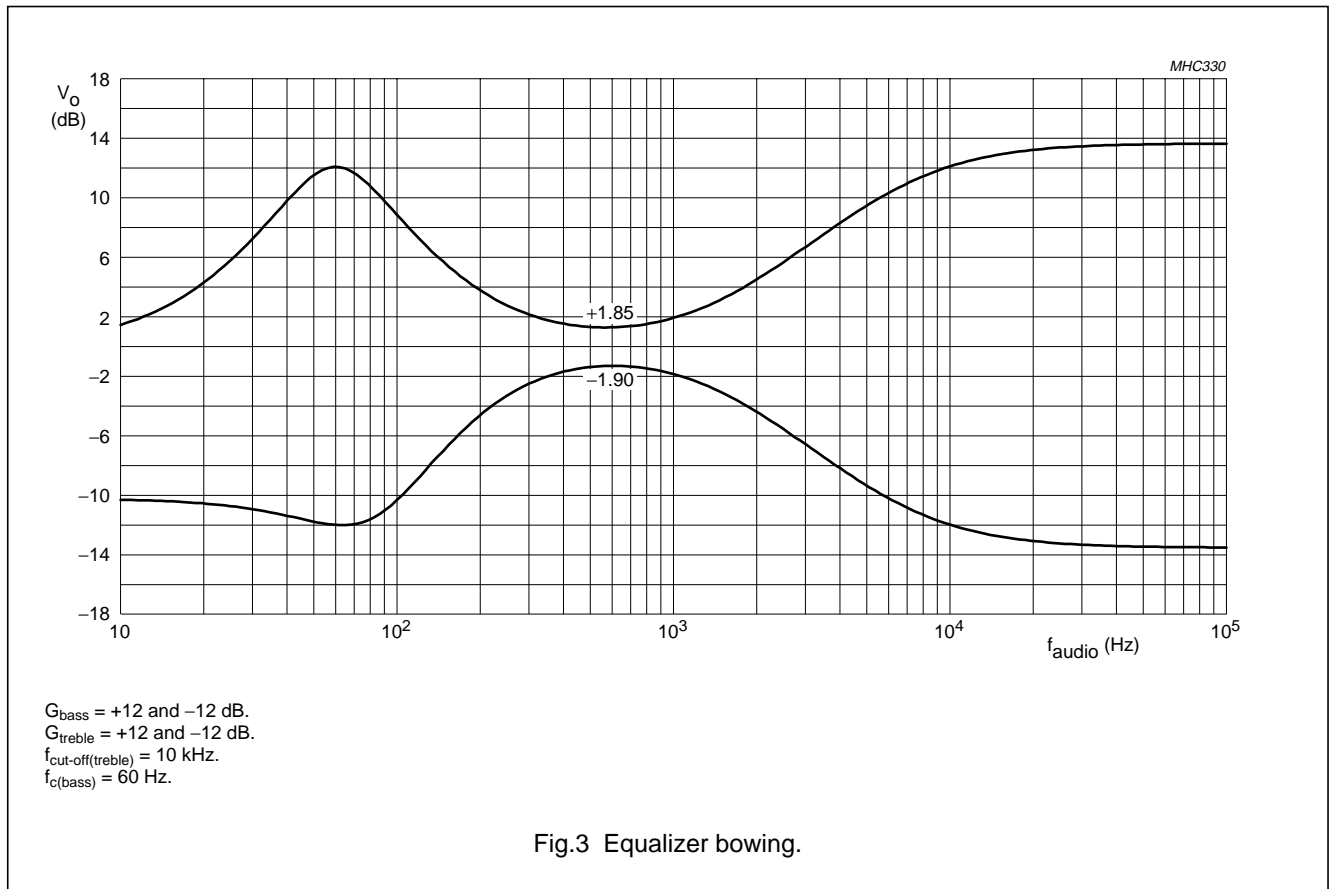

## Car radio integrated signal processor

TEF6890H

11 I<sup>2</sup>C-BUS PROTOCOL

Table 1 Write mode

S <sup>(1)</sup>	address (write)	A <sup>(2)</sup>	subaddress	A <sup>(2)</sup>	data byte(s)	A <sup>(2)</sup>	P <sup>(3)</sup>
------------------	-----------------	------------------	------------	------------------	--------------	------------------	------------------

## Notes

1. S = START condition.
2. A = acknowledge.
3. P = STOP condition.

Table 2 Read mode

S <sup>(1)</sup>	address (read)	A <sup>(2)</sup>	data byte(s)	A <sup>(2)</sup>	data byte	NA <sup>(3)</sup>	P <sup>(4)</sup>
------------------	----------------	------------------	--------------	------------------	-----------	-------------------	------------------

## Notes

1. S = START condition.
2. A = acknowledge.
3. NA = not acknowledge.
4. P = STOP condition.

Table 3 IC address byte

IC ADDRESS						MODE
0	0	1	1	0	0	ADDR
						R/ $\bar{W}$

Table 4 Description of IC address byte

BIT	SYMBOL	DESCRIPTION
7 to 2	–	001100+(ADDR) = IC address.
1	ADDR	<b>Address bit.</b> 0 = pin ADDR is grounded; 1 = pin ADDR is floating.
0	R/ $\bar{W}$	<b>Read/Write.</b> 0 = write mode; 1 = read mode.

## 11.1 Read mode

## 11.1.1 DATA BYTE 1; STATUS

Table 5 Format of data byte 1

BIT 7	BIT 6	BIT 5	BIT 4	BIT 3	BIT 2	BIT 1	BIT 0
STIN	ASIA	AFUS	POR	–	ID2	ID1	ID0



Car radio integrated signal processor

TEF6890H

**Table 6** Description of data byte 1

BIT	SYMBOL	DESCRIPTION
7	STIN	<b>Stereo indicator.</b> 0 = no pilot signal detected; 1 = pilot signal detected.
6	ASIA	<b>ASI active.</b> 0 = not active; 1 = ASI step is in progress.
5	AFUS	<b>AF update sample.</b> 0 = LEV, USN and WAM information is taken from main frequency (continuous mode); 1 = LEV, USN and WAM information is taken from alternative frequency. Continuous mode during AF update and sampled mode after AF update. Sampled mode reverts to continuous main frequency information after read.
4	POR	<b>Power-on reset.</b> 0 = standard operation (valid I <sup>2</sup> C-bus register settings); 1 = Power-on reset detected since last read cycle (I <sup>2</sup> C-bus register reset). After read the bit will reset to POR = 0.
3	–	<b>Reserved.</b>
2 to 0	ID[2:0]	<b>Identification.</b> TEF6890H device type identification; ID[2:0] = 000.

11.1.2 DATA BYTE 2; LEVEL

**Table 7** Format of data byte 2

BIT 7	BIT 6	BIT 5	BIT 4	BIT 3	BIT 2	BIT 1	BIT 0
LEV7	LEV6	LEV5	LEV4	LEV3	LEV2	LEV1	LEV0

**Table 8** Description of data byte 2

BIT	SYMBOL	DESCRIPTION
7 to 0	LEV[7:0]	<b>Level.</b> 8-bit value of level voltage from tuner; see Fig.4.

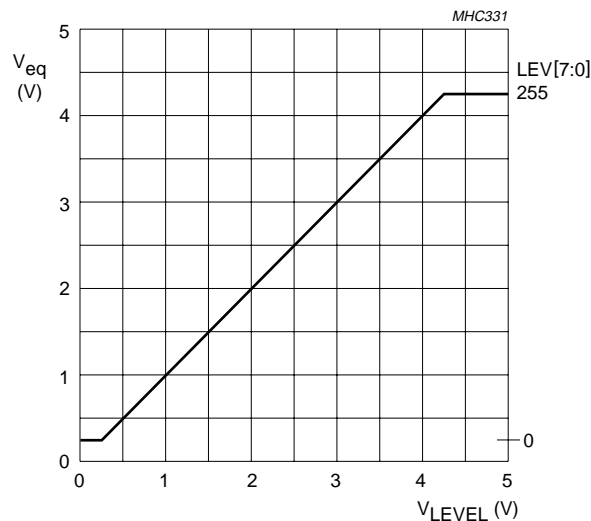

Fig.4 Equivalent level voltage  $V_{eq}$  (MPH and LEV detector) as a function of level voltage  $V_{LEVEL}$ .

## Car radio integrated signal processor

TEF6890H

## 11.1.3 DATA BYTE 3; USN AND WAM

**Table 9** Format of data byte 3

BIT 7	BIT 6	BIT 5	BIT 4	BIT 3	BIT 2	BIT 1	BIT 0
USN3	USN2	USN1	USN0	WAM3	WAM2	WAM1	WAM0

**Table 10** Description of data byte 3

BIT	SYMBOL	DESCRIPTION
7 to 4	USN[3:0]	<b>Ultrasonic noise detector.</b> USN content of the MPXRDS audio signal; see Fig.5.
3 to 0	WAM[3:0]	<b>Wideband AM detector.</b> WAM content of the LEVEL voltage; see Fig.6.

## 11.2 Write mode

**Table 11** Format for subaddress byte with default setting

BIT 7	BIT 6	BIT 5	BIT 4	BIT 3	BIT 2	BIT 1	BIT 0
AIOF	GATE	SGAT	SA4	SA3	SA2	SA1	SA0
–	0	0	–	–	–	–	–

**Table 12** Description of subaddress byte

BIT	SYMBOL	DESCRIPTION
7	AIOF	<b>Auto-increment off.</b> 0 = auto-increment enabled; 1 = auto-increment disabled.
6	GATE	<b>Gate.</b> 0 = I <sup>2</sup> C-bus outputs (SDAG and SCLG) are controllable by the shortgate or the autogate function; 1 = I <sup>2</sup> C-bus outputs are enabled.
5	SGAT	<b>Shortgate.</b> 1 = I <sup>2</sup> C-bus outputs (SDAG and SCLG) are enabled for a single transmission following this control and disabled automatically.
4 to 0	SA[4:0]	<b>Data byte select.</b> The subaddress value is auto-incremented when AIOF = 0 and will revert from SA = 30 to SA = 0. SA = 31 can only be accessed via direct subaddress selection, in which case auto-increment will revert from SA = 31 to SA = 0; see Table 13.

**Table 13** Selection of data byte

SA4	SA3	SA2	SA1	SA0	HEX <sup>(1)</sup>	MNEMONIC	ADDRESSED DATA BYTE
0	0	0	1	0	2	RDSCLK	clock of RDS/RBDS
0	0	1	0	0	4	CONTROL	control of supply and AF update
0	0	1	0	1	5	CSALIGN	alignment of stereo channel separation
0	0	1	1	0	6	MULTIPATH	control of weak signal sensitivity and timing
0	0	1	1	1	7	SNC	alignment of SNC start and slope
0	1	0	0	0	8	HIGHCUT	alignment of HCC start and slope
0	1	0	0	1	9	SOFTMUTE	alignment soft mute start and slope
0	1	0	1	0	A	RADIO	control of radio functions
0	1	0	1	1	B	INPUT/ASI	input selector and ASI settings
0	1	1	0	0	C	LOUDNESS	loudness control
0	1	1	0	1	D	VOLUME	volume control
0	1	1	1	0	E	TREBLE	treble control

## Car radio integrated signal processor

TEF6890H

SA4	SA3	SA2	SA1	SA0	HEX <sup>(1)</sup>	MNEMONIC	ADDRESSED DATA BYTE
0	1	1	1	1	F	BASS	bass control
1	0	0	0	0	10	FADER	fader control
1	0	0	0	1	11	BALANCE	balance control
1	0	0	1	0	12	MIX	control of output mixer
1	0	0	1	1	13	BEEP	beep generator settings
1	1	1	1	1	1F	AUTOGATE	autogate control

**Note**

1. Data bytes 0, 1 and 3 must not be used in the application. All bits in these bytes must be set to logic 0.

## 11.2.1 SUBADDRESS 2H; RDSCLK

**Table 14** Format of data byte 2H with default setting

BIT 7	BIT 6	BIT 5	BIT 4	BIT 3	BIT 2	BIT 1	BIT 0
–	–	TST3	TST2	TST1	TST0	CLKO	CLKI
–	–	0	0	0	0	0	1

**Table 15** Description of data byte 2H

BIT	SYMBOL	DESCRIPTION
7 and 6	–	Not used. Set to logic 0.
5 to 2	TST[3:0]	<b>Test.</b> TST[3:0] = 0000: normal operation.
1	CLKO	<b>Clock input or output and buffered or unbuffered raw RDS output.</b> See Table 16.
0	CLKI	

**Table 16** RDS clock description

CLKO	CLKI	RDS/RBDS CLOCK
0	0	reserved
0	1	RDCL is burst clock input for raw RDS read-out.
1	0	RDCL is clock output for raw RDS read-out.
1	1	reserved

## 11.2.2 SUBADDRESS 4H; CONTROL

**Table 17** Format of data byte 4H with default setting

BIT 7	BIT 6	BIT 5	BIT 4	BIT 3	BIT 2	BIT 1	BIT 0
STBR	STBA	AFUM	AFUH	RMUT	–	LETF	ATTB
1	1	0	0	0	–	0	0

## Car radio integrated signal processor

TEF6890H

**Table 18** Description of data byte 4H

BIT	SYMBOL	DESCRIPTION
7	STBR	<b>Standby mode RDS processing.</b> 0 = RDS processing active; 1 = RDS processing in standby mode (RDS off, RDS outputs LOW).
6	STBA	<b>Standby mode audio processing.</b> 0 = audio processing active; 1 = audio processing in standby mode (audio inputs and outputs at DC).
5	AFUM	<b>Enables AF update mute.</b> 0 = AF update mute disabled; 1 = AF update mute enabled (controlled by AFSAMP and AFHOLD input).
4	AFUH	<b>AF update hold function.</b> 0 = disable, the weak signal processing hold is controlled by the AFHOLD input only; 1 = hold. This is equal to taking the AFHOLD input LOW. The bit is reset to 0, when AFHOLD input is set to LOW (i.e. at AF update or preset change).
3	RMUT	<b>Radio signal mute.</b> 0 = no mute; 1 = mute with 1 ms ASI slope at start and stop.
2	–	Not used. Set to logic 0.
1	LETF	<b>Fast level detector time constants.</b> 0 = slow level detector time constants are used; 1 = fast level detector time constants are used. See Table 25.
0	ATTB	<b>Attack bound of the MPH and LEV detector.</b> 0 = detectors are unbounded; 1 = range of the MPH and LEV detector are limited in their range for immediate start of attack. In AM mode the detectors are always unbounded.

## 11.2.3 SUBADDRESS 5H; CSALIGN

**Table 19** Format of data byte 5H with default setting

BIT 7	BIT 6	BIT 5	BIT 4	BIT 3	BIT 2	BIT 1	BIT 0
CSR1	CSR0	CSA3	CSA2	CSA1	CSA0	–	–
0	1	0	1	1	1	–	–

**Table 20** Description of data byte 5H

BIT	SYMBOL	DESCRIPTION
7 and 6	CSR[1:0]	<b>FM stereo channel separation (high frequency).</b> See Table 21.
5 to 2	CSA[3:0]	<b>FM stereo channel separation and adjustment.</b> See Table 22.
1 and 0	–	Not used. Set to logic 0.

**Table 21** FM stereo channel separation

CSR1	CSR0	FM STEREO CHANNEL SEPARATION (dB)
0	0	0
0	1	0.4
1	0	0.8
1	1	1.2

## Car radio integrated signal processor

TEF6890H

**Table 22** FM stereo channel separation and adjustment

CSA3	CSA2	CSA1	CSA0	FM STEREO CHANNEL SEPARATION AND ADJUSTMENT (dB)
0	0	0	0	0
0	0	0	1	0.2
:	:	:	:	:
1	1	1	0	2.8
1	1	1	1	3.0

## 11.2.4 SUBADDRESS 6H; MULTIPATH

**Table 23** Format of data byte 6H with default setting

BIT 7	BIT 6	BIT 5	BIT 4	BIT 3	BIT 2	BIT 1	BIT 0
USS1	USS0	WAS1	WAS0	LET1	LET0	MPT1	MPT0
0	1	0	1	0	0	0	0

**Table 24** Description of data byte 6H

BIT	SYMBOL	DESCRIPTION
7 and 6	USS[1:0]	<b>USN sensitivity for weak signal processing.</b> See Fig.5.
5 and 4	WAS[1:0]	<b>WAM sensitivity for weak signal processing.</b> See Fig.6.
3 and 2	LET[1:0]	<b>LEVEL detector time constant.</b> See Table 25.
1 and 0	MPT[1:0]	<b>MPH detector time constants (level, WAM and USN).</b> See Table 26.

**Table 25** Setting of the time constants of the LEVEL detector

LETF	LET1	LET0	$t_{LEVEL}$ (s)	
			ATTACK	DECAY
0	0	0	3	3
0	0	1	3	6
0	1	0	1.5	1.5
0	1	1	0.5	1.5
1	0	0	0.5	0.5
1	0	1	0.17	0.5
1	1	0	0.06	0.17
1	1	1	0.06	0.06

**Table 26** Setting of the time constants of the MPH detector (level, WAM and USN)

MPT1	MPT0	$t_{MPH}$ (s)	
		ATTACK	DECAY
0	0	0.5	12
0	1	0.5	24
1	0	0.5	6
1	1	0.25	6

Car radio integrated signal processor

TEF6890H

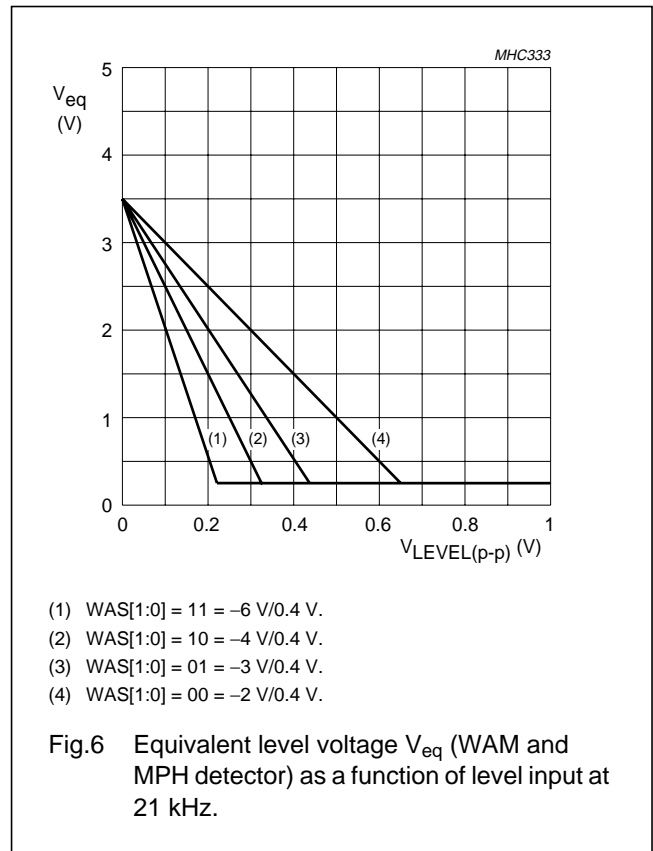
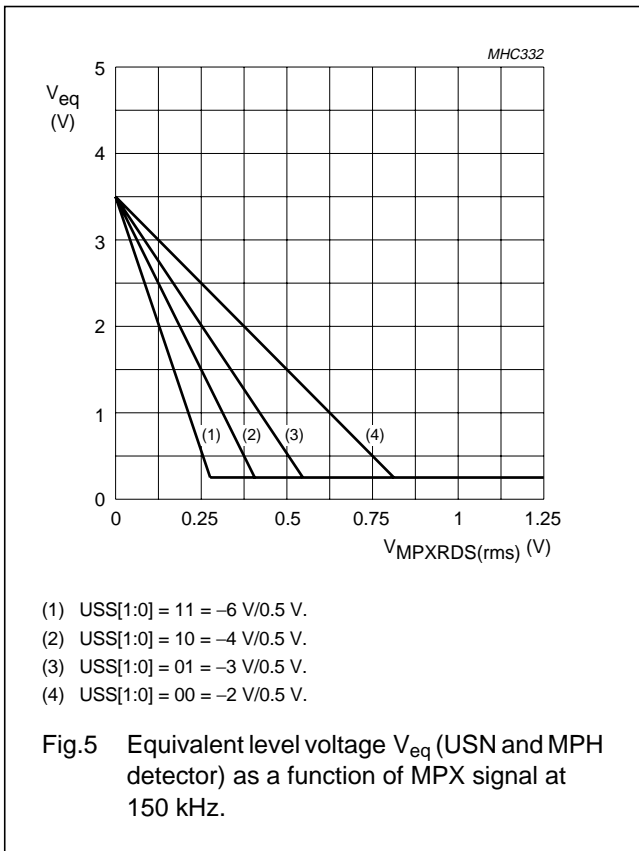

11.2.5 SUBADDRESS 7H; SNC

Table 27 Format of data byte 7H with default setting

BIT 7	BIT 6	BIT 5	BIT 4	BIT 3	BIT 2	BIT 1	BIT 0
SST3	SST2	SST1	SST0	SSL1	SSL0	HCMP	HCSF
0	1	1	1	0	1	0	0

Table 28 Description of data byte 7H

BIT	SYMBOL	DESCRIPTION
7 to 4	SST[3:0]	<b>Start of the stereo blend SNC.</b> See Table 29 and Fig.7.
3 and 2	SSL[1:0]	<b>Slope of the stereo blend SNC.</b> See Fig.8.
1	HCMP	<b>High cut control source.</b> 0 = control by the level (LEV) detector; 1 = control by the multipath (MPH) detector.
0	HCSF	<b>High cut control minimum bandwidth.</b> 0 = 2 kHz; 1 = 3 kHz.

Car radio integrated signal processor

TEF6890H

**Table 29** Start of the stereo blend SNC

SST3	SST2	SST1	SST0	STEREO NOISE CONTROL START VOLTAGE (V)
0	0	0	0	1.88
0	0	0	1	1.94
0	0	1	0	2
0	0	1	1	2.06
0	1	0	0	2.13
0	1	0	1	2.19
0	1	1	0	2.25
0	1	1	1	2.31

SST3	SST2	SST1	SST0	STEREO NOISE CONTROL START VOLTAGE (V)
1	0	0	0	2.38
1	0	0	1	2.44
1	0	1	0	2.5
1	0	1	1	2.56
1	1	0	0	2.63
1	1	0	1	2.69
1	1	1	0	2.75
1	1	1	1	2.81

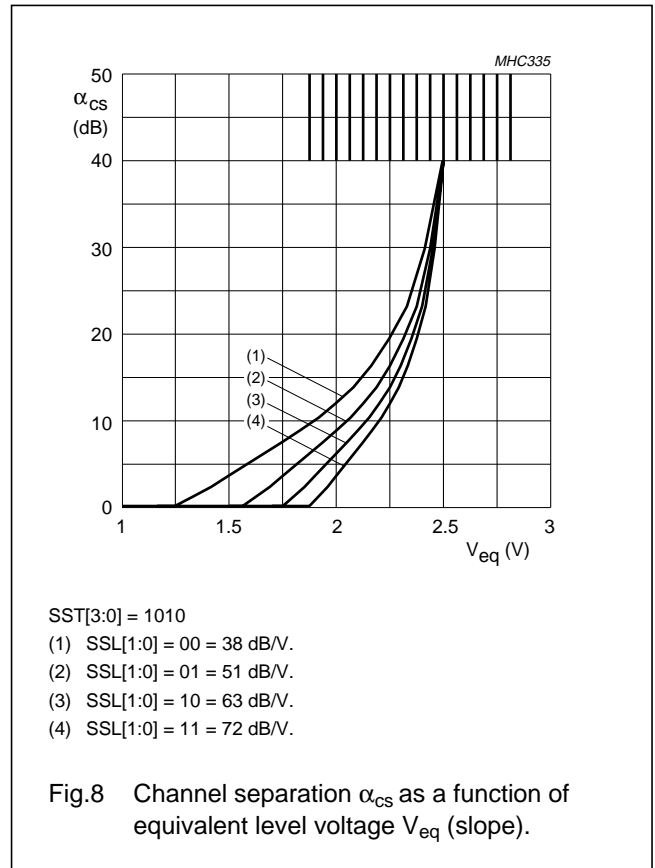
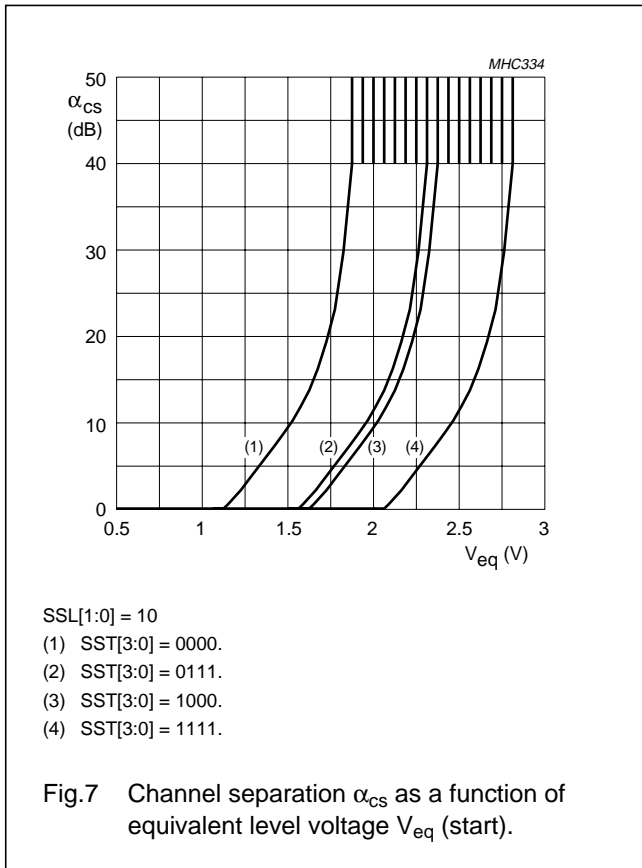

Car radio integrated signal processor

TEF6890H

11.2.6 SUBADDRESS 8H; HIGHCUT

**Table 30** Format of data byte 8H with default setting

BIT 7	BIT 6	BIT 5	BIT 4	BIT 3	BIT 2	BIT 1	BIT 0
HST2	HST1	HST0	HSL1	HSL0	HCF2	HCF1	HCF0
0	1	1	0	1	1	1	1

**Table 31** Description of data byte 8H

BIT	SYMBOL	DESCRIPTION
7 to 5	HST[2:0]	<b>High cut control start (weak signal processing).</b> See Fig.9.
4 and 3	HSL[1:0]	<b>High cut control slope (weak signal processing).</b> See Fig.10.
2 to 0	HCF[2:0]	<b>Fixed high cut control (maximum HCC bandwidth).</b> See Table 32 and Fig.11.

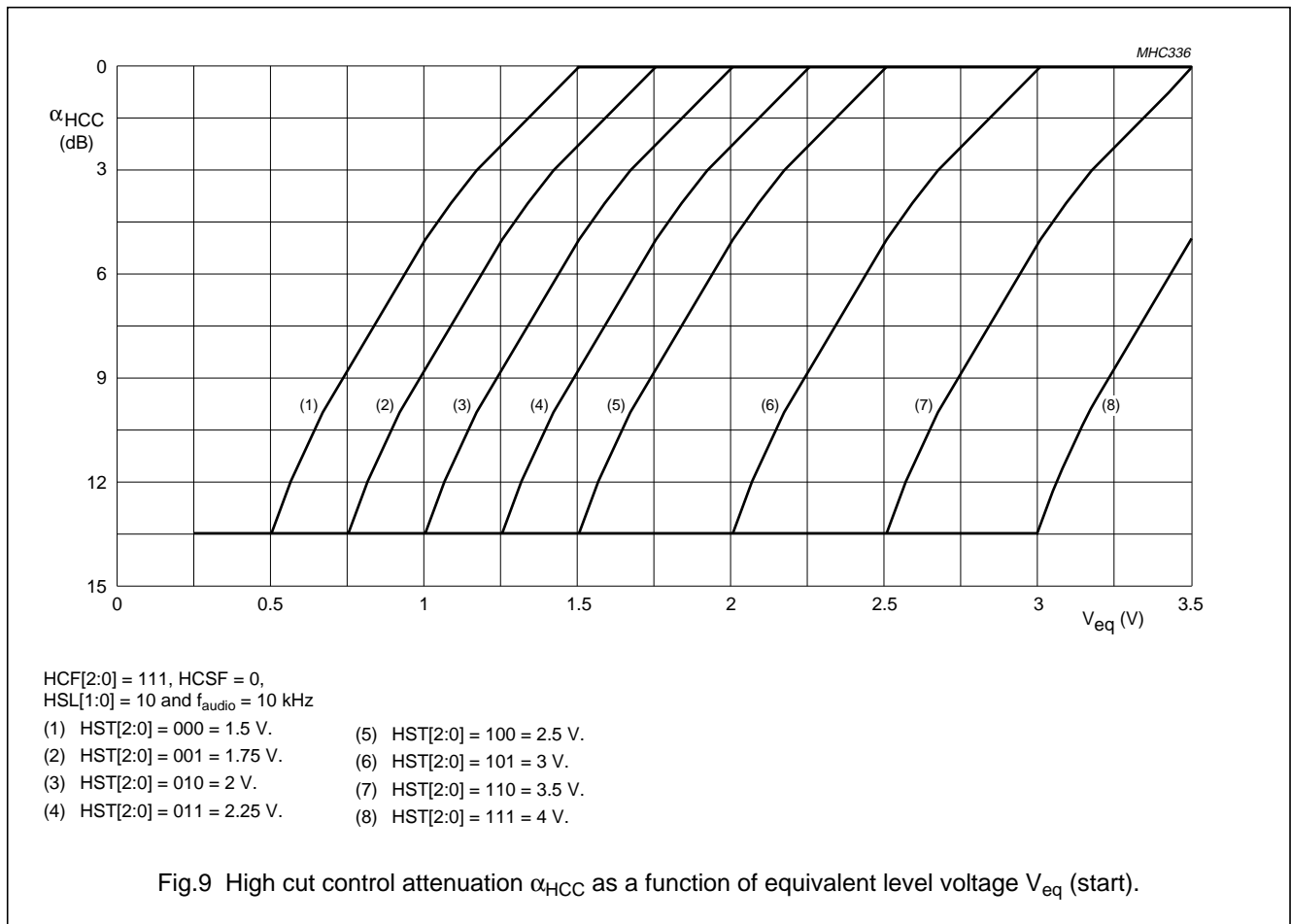



Car radio integrated signal processor

TEF6890H

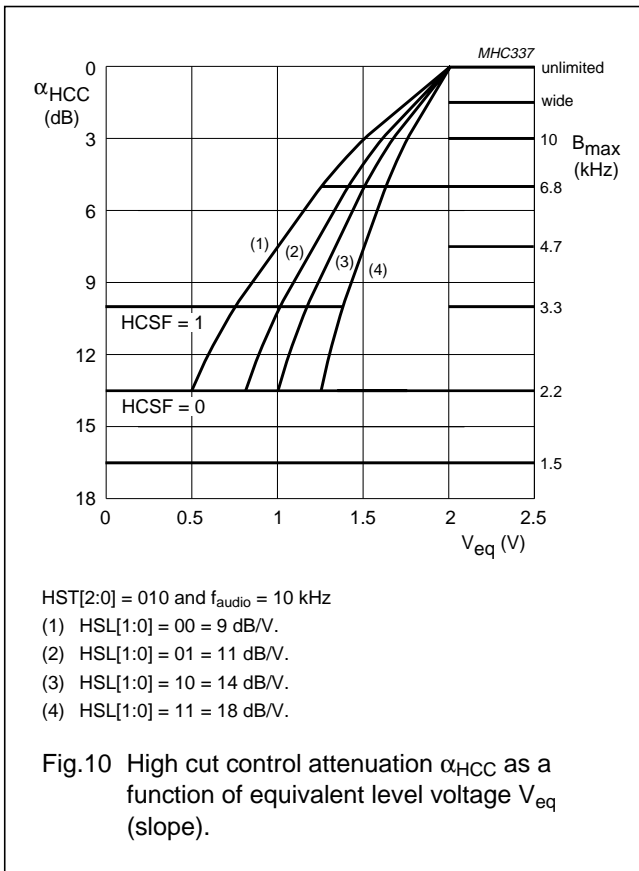

**Table 32** Fixed high cut control

HCF2	HCF1	HCF0	$B_{max}$ (kHz)
0	0	0	1.5
0	0	1	2.2
0	1	0	3.3
0	1	1	4.7
1	0	0	6.8
1	0	1	10
1	1	0	wide
1	1	1	unlimited

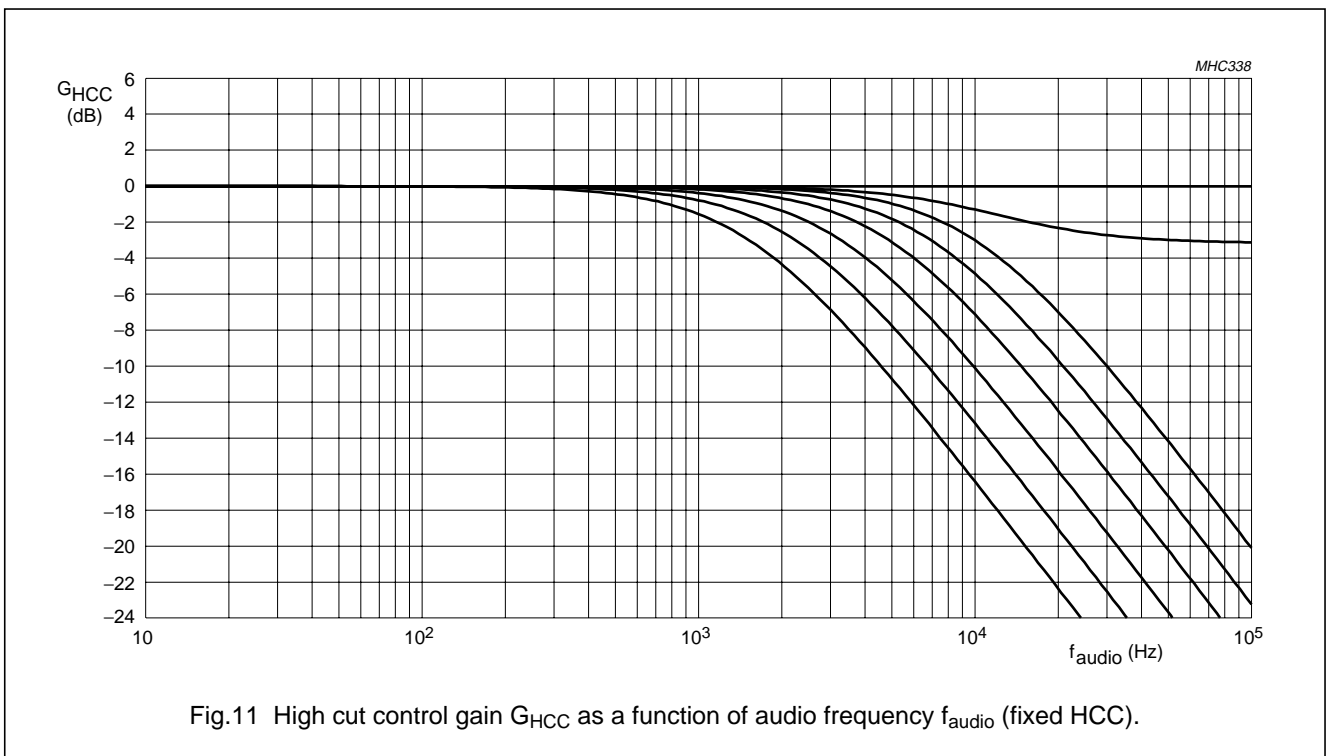

Car radio integrated signal processor

TEF6890H

11.2.7 SUBADDRESS 9H; SOFTMUTE

**Table 33** Format of data byte 9H with default setting

BIT 7	BIT 6	BIT 5	BIT 4	BIT 3	BIT 2	BIT 1	BIT 0
MST2	MST1	MST0	MSL1	MSL0	UMD1	UMD0	SMON
0	1	1	0	1	0	1	1

**Table 34** Description of data byte 9H

BIT	SYMBOL	DESCRIPTION
7 to 5	MST[2:0]	<b>Soft mute start.</b> $\alpha_{mute} = 3$ dB; see Fig.12.
4 and 3	MSL[1:0]	<b>Soft mute slope.</b> See Fig.13.
2 and 1	UMD[1:0]	<b>USN mute depth.</b> Maximum soft mute attenuation of the soft mute via USN control; see Fig.14.
0	SMON	<b>Soft mute enable.</b> 0 = disable; 1 = enable.

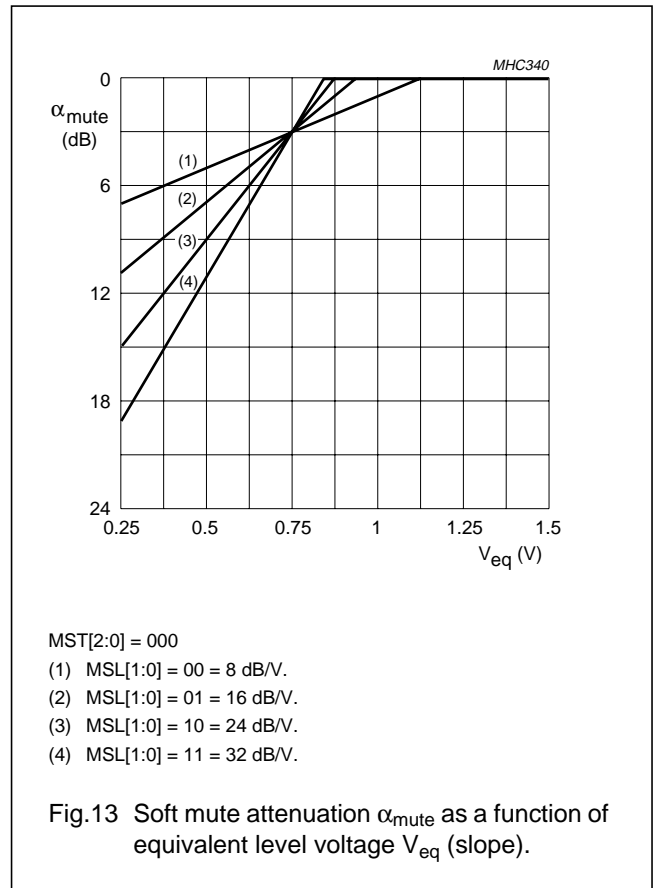
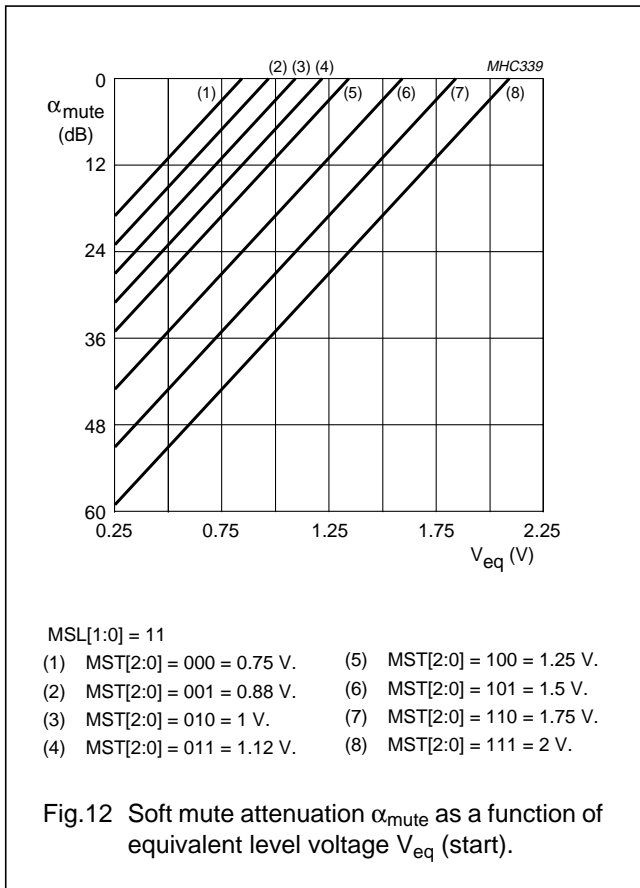

Car radio integrated signal processor

TEF6890H

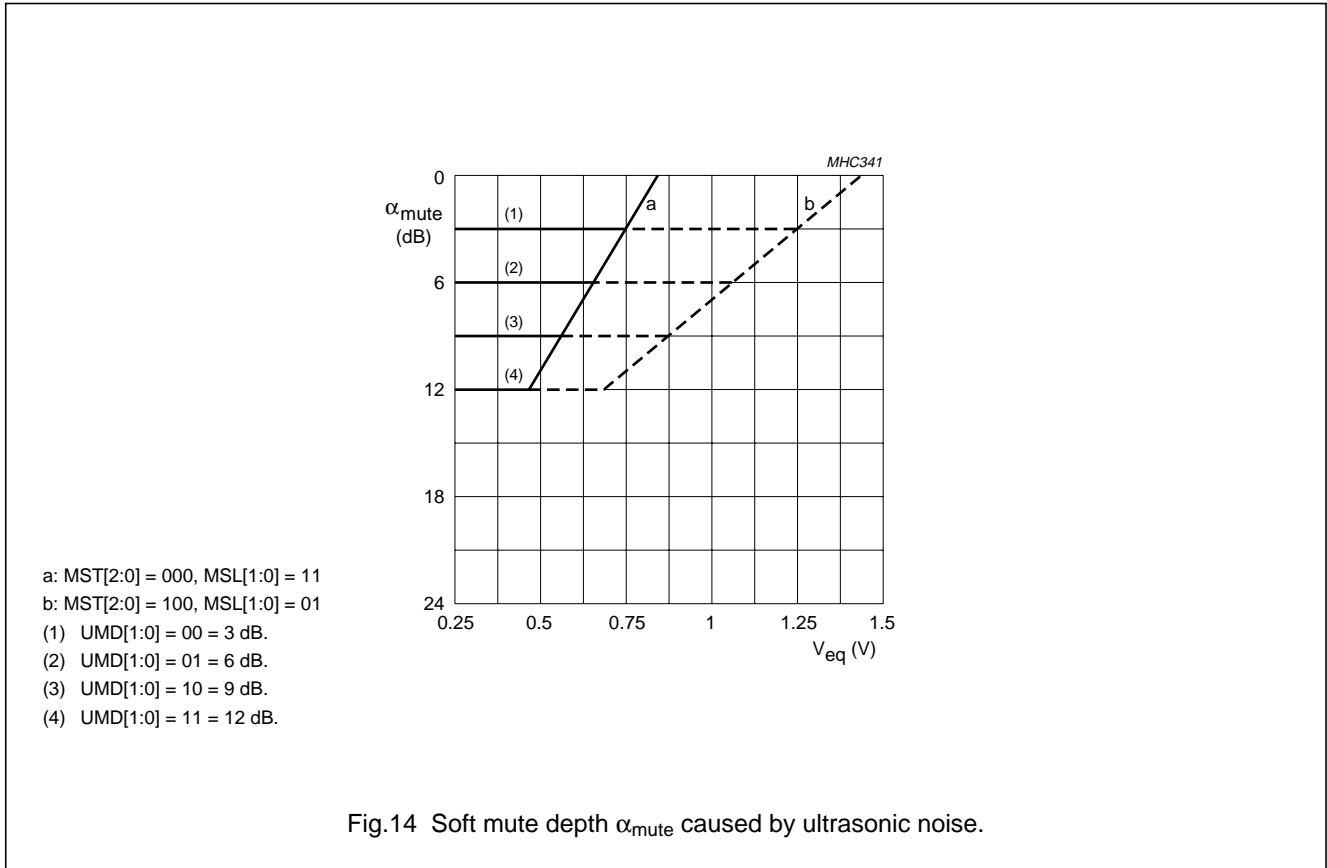

11.2.8 SUBADDRESS AH; RADIO

Table 35 Format of data byte AH with default setting

BIT 7	BIT 6	BIT 5	BIT 4	BIT 3	BIT 2	BIT 1	BIT 0
AM	MONO	DEMP	ING1	ING0	SEAR	NBS1	NBS0
0	0	1	0	0	1	1	0

Table 36 Description of data byte AH

BIT	SYMBOL	DESCRIPTION
7	AM	<b>AM selection.</b> 0 = FM mode selected; 1 = AM mode selected.
6	MONO	<b>Stereo decoder mono.</b> 0 = set to FM stereo; 1 = set to FM mono.
5	DEMP	<b>De-emphasis time constant.</b> 0 = 75 $\mu$ s; 1 = 50 $\mu$ s; see Fig.15.
4 and 3	ING[1:0]	<b>Input gain.</b> See Table 37.
2	SEAR	<b>LEVEL and MPH detector time constant.</b> 0 = standard time constant selected; 1 = fast time constant of 60 ms selected.
1 and 0	NBS[1:0]	<b>AM noise blanker and the FM noise blanker MPX sensitivity.</b> See Table 38.

Car radio integrated signal processor

TEF6890H

**Table 37** Input gain

ING1	ING0	GAIN FOR FMMPX INPUT (dB)	GAIN FOR AM AND MPXRDS INPUT (dB)
0	0	0	0
0	1	3	3
1	0	6	6
1	1	23.5	0

**Table 38** Noise blanker sensitivity

NBS1	NBS0	SENSITIVITY OF FM NOISE BLANKER AT MPXRDS INPUT (mV)	SENSITIVITY OF AM NOISE BLANKER (%)
0	0	90	110
0	1	150	140
1	0	210	175
1	1	270	220

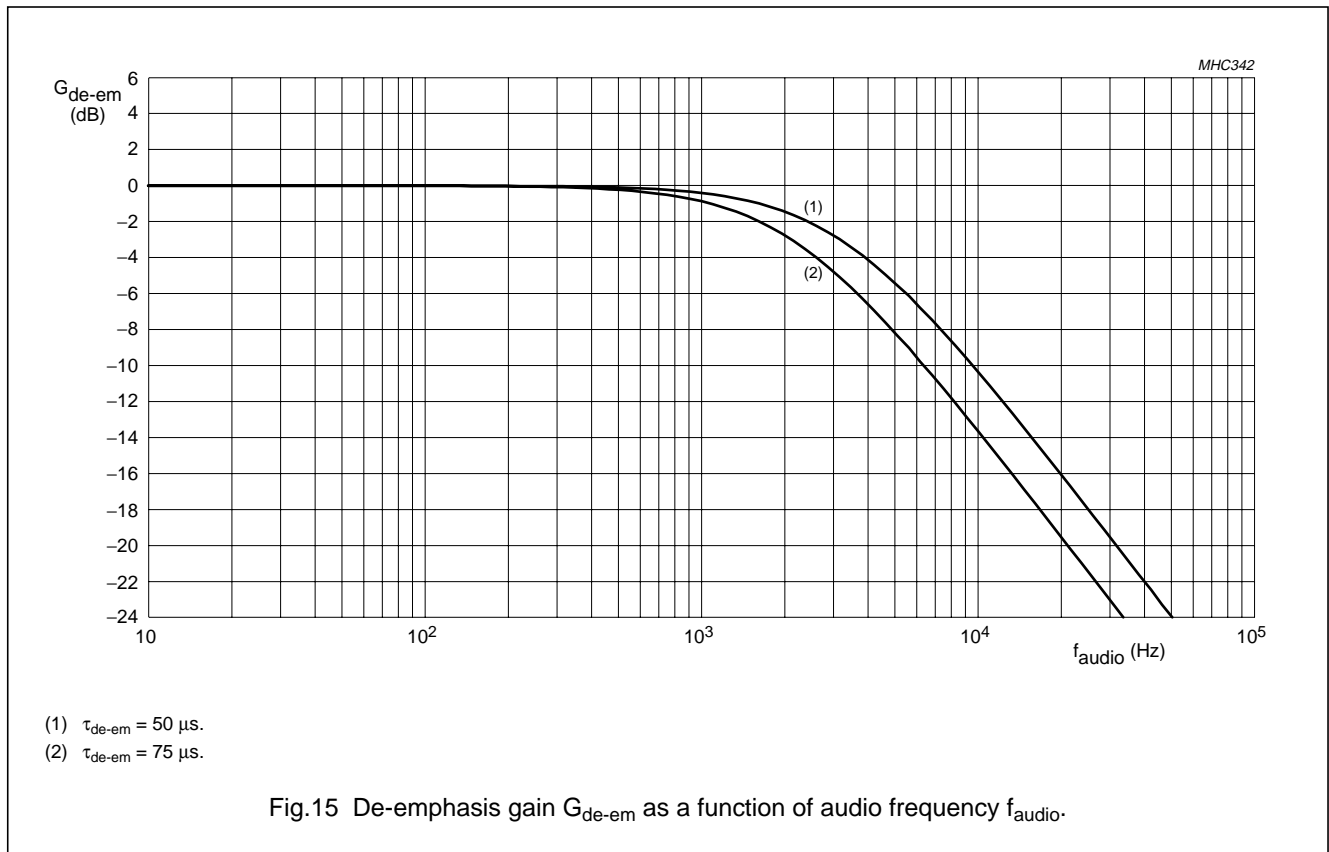

## Car radio integrated signal processor

TEF6890H

## 11.2.9 SUBADDRESS BH; INPUT AND ASI

**Table 39** Format of data byte BH with default setting

BIT 7	BIT 6	BIT 5	BIT 4	BIT 3	BIT 2	BIT 1	BIT 0
NBL1	NBL0	INP1	INP0	MUTE	ASI	AST1	AST0
1	0	0	0	1	1	0	0

**Table 40** Description of data byte BH

BIT	SYMBOL	DESCRIPTION
7 and 6	NBL[1:0]	<b>FM noise blanker level sensitivity.</b> See Table 41.
5 and 4	INP[1:0]	<b>Audio input tone/volume part.</b> See Table 42.
3	MUTE	<b>Audio mute.</b> 0 = no mute; 1 = mute.
2	ASI	<b>Audio step interpolation.</b> 0 = disable; 1 = enable.
1 and 0	AST[1:0]	<b>Audio step interpolation time constant.</b> ASI time is 0 s when ASI = 0; see Table 43.

**Table 41** FM noise blanker level sensitivity

NBL1	NBL0	SENSITIVITY OF FM NOISE BLANKER AT LEVEL INPUT (mV)
0	0	9
0	1	18
1	0	28
1	1	reserved

**Table 42** Audio input tone/volume part

INP1	INP0	AUDIO INPUT FOR TONE/VOLUME PART
0	0	radio
0	1	CD
1	0	tape
1	1	phone

**Table 43** Audio step interpolation time constant

AST1	AST0	ASI TIME (ms)
0	0	1
0	1	3
1	0	10
1	1	30

## 11.2.10 SUBADDRESS CH; LOUDNESS

**Table 44** Format of data byte CH with default setting

BIT 7	BIT 6	BIT 5	BIT 4	BIT 3	BIT 2	BIT 1	BIT 0
–	LDN4	LDN3	LDN2	LDN1	LDN0	LLF	LHB
–	0	0	0	0	0	1	1

Car radio integrated signal processor

TEF6890H

**Table 45** Description of data byte CH, see Figs 16 to 19

BIT	SYMBOL	DESCRIPTION
7	–	Not used. Set to logic 0.
6 to 2	LDN[4:0]	<b>Loudness gain.</b> See Table 46.
1	LLF	<b>Loudness low boost frequency.</b> 0 = 50 Hz; 1 = 100 Hz.
0	LHB	<b>Loudness high boost enable.</b> 0 = loudness low boost is enabled; 1 = loudness low boost and loudness high boost are enabled.

**Table 46** Loudness gain

LDN4	LDN3	LDN2	LDN1	LDN0	LOUDNESS CONTROL (dB)
0	0	0	0	0	0
0	0	0	0	1	-1
0	0	0	1	0	-2
:	:	:	:	:	:
1	0	0	1	0	-18
1	0	0	1	1	-19
1	0	1	0	0	-20

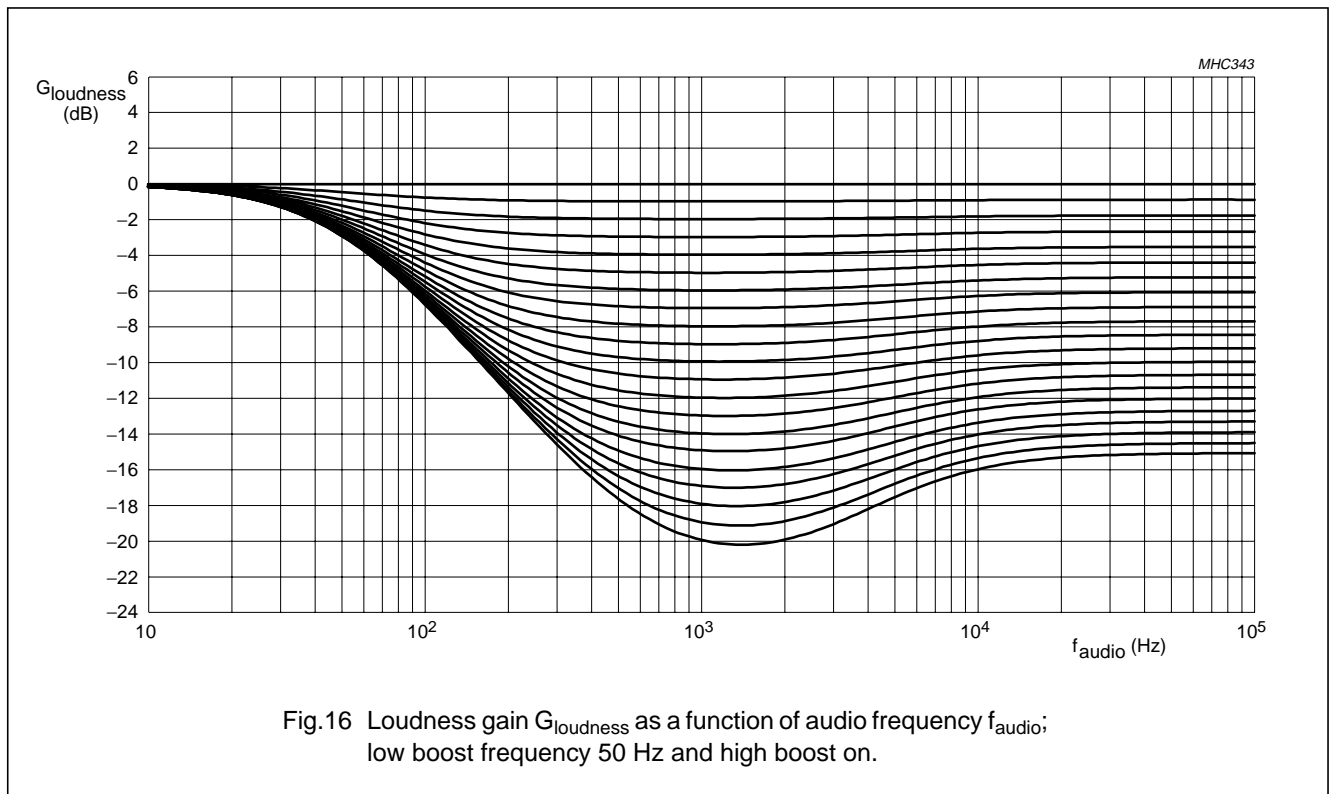

Car radio integrated signal processor

TEF6890H

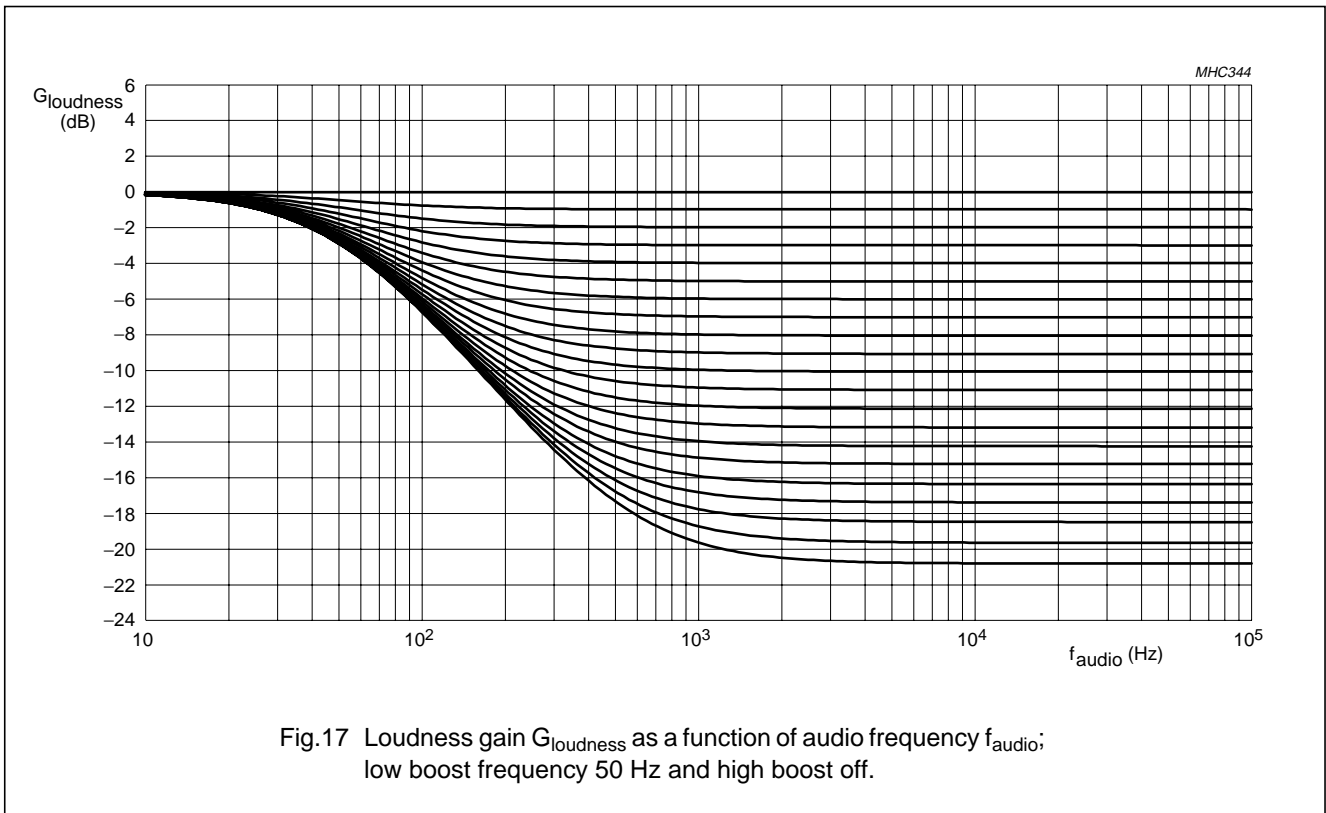

Fig.17 Loudness gain  $G_{loudness}$  as a function of audio frequency  $f_{audio}$ ; low boost frequency 50 Hz and high boost off.

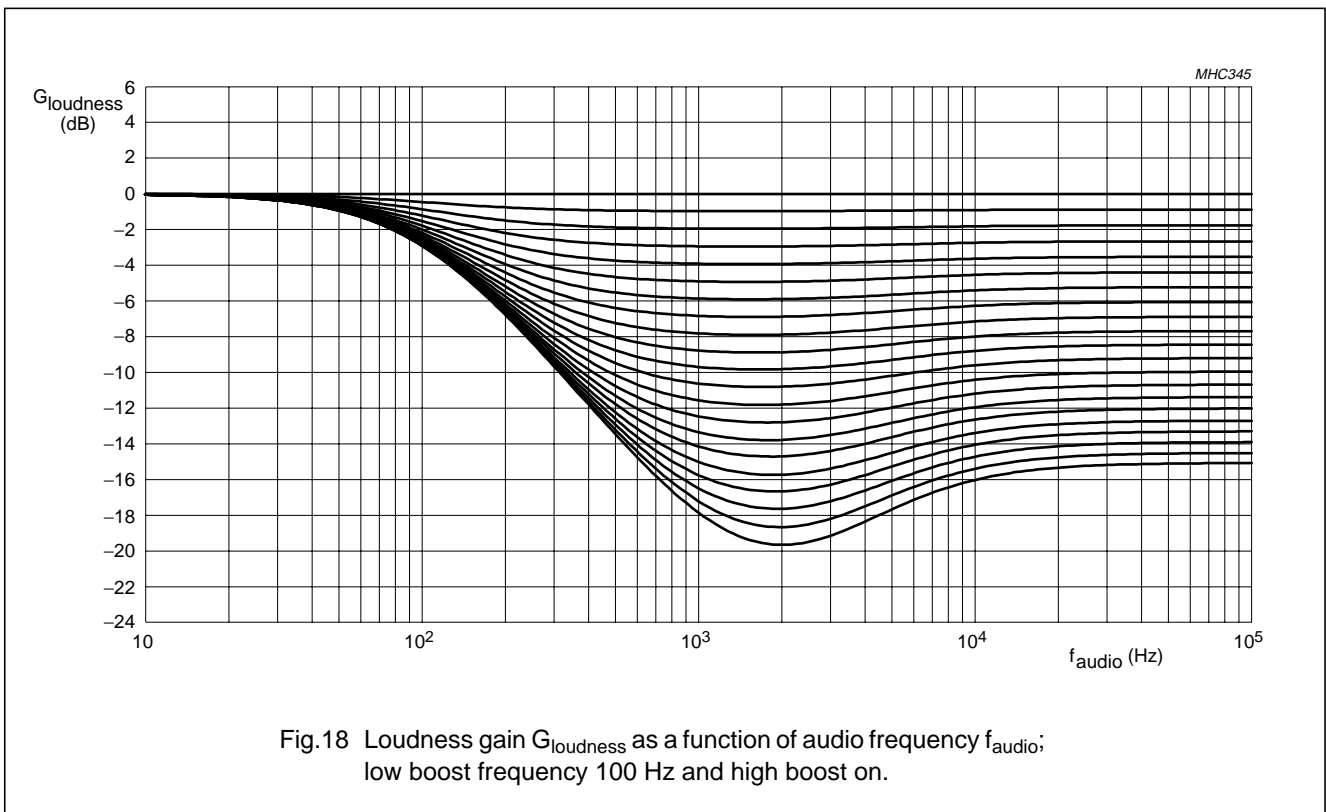
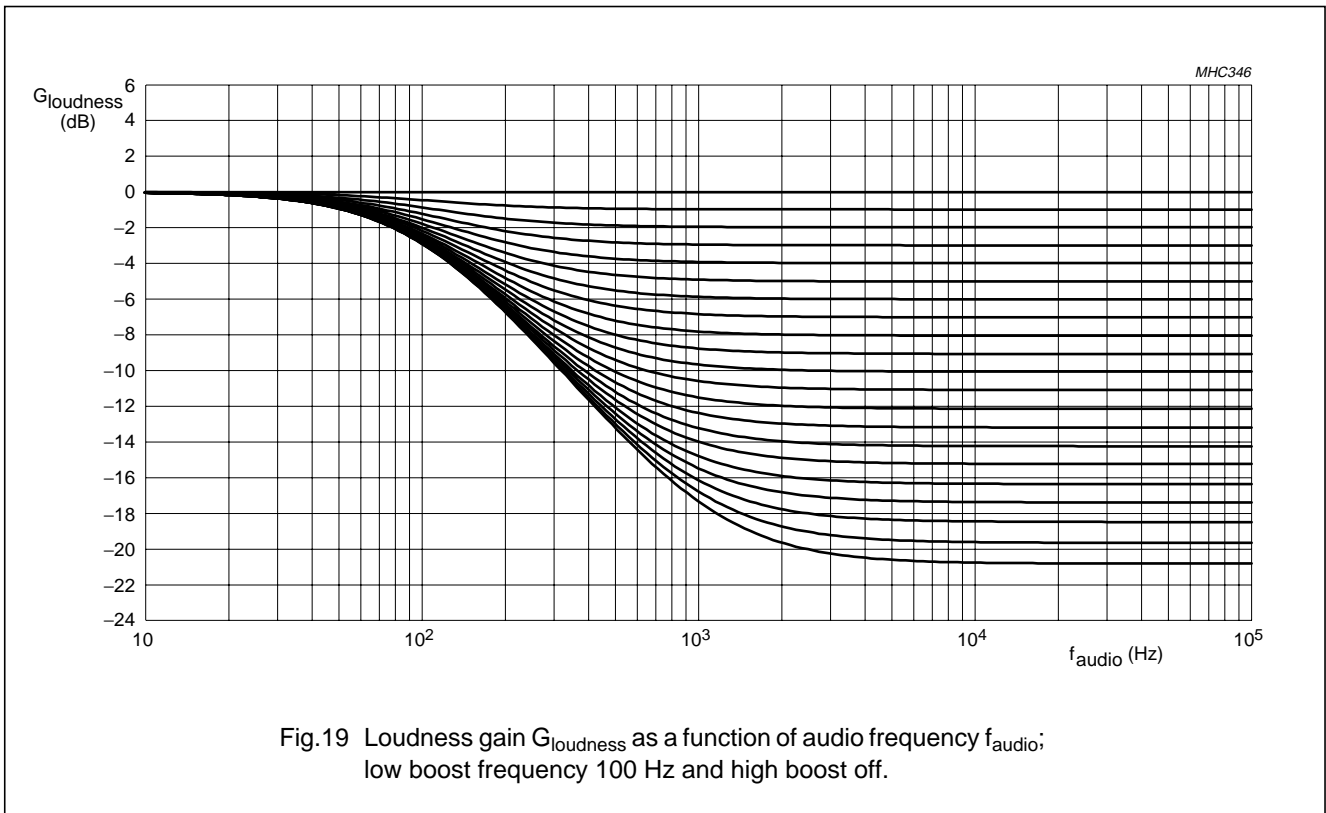

Fig.18 Loudness gain  $G_{loudness}$  as a function of audio frequency  $f_{audio}$ ; low boost frequency 100 Hz and high boost on.

Car radio integrated signal processor

TEF6890H



11.2.11 SUBADDRESS DH; VOLUME

**Table 47** Format of data byte DH with default setting

BIT 7	BIT 6	BIT 5	BIT 4	BIT 3	BIT 2	BIT 1	BIT 0
–	VOL6	VOL5	VOL4	VOL3	VOL2	VOL1	VOL0
–	0	1	0	0	0	0	0

**Table 48** Description of data byte DH

BIT	SYMBOL	DESCRIPTION
7	–	Not used. Set to logic 0.
6 to 0	VOL[6:0]	<b>Volume setting.</b> See Table 49.

**Table 49** Volume setting

VOL6	VOL5	VOL4	VOL3	VOL2	VOL1	VOL0	GAIN (dB)
0	0	0	1	1	0	0	20
0	0	0	1	1	0	1	19
0	0	0	1	1	1	0	18
:	:	:	:	:	:	:	:
0	0	1	1	1	1	0	2
0	0	1	1	1	1	1	1
0	1	0	0	0	0	0	0



## Car radio integrated signal processor

TEF6890H

VOL6	VOL5	VOL4	VOL3	VOL2	VOL1	VOL0	GAIN (dB)
0	1	0	0	0	0	1	-1
0	1	0	0	0	1	0	-2
:	:	:	:	:	:	:	:
1	0	1	1	0	1	0	-58
1	0	1	1	0	1	1	-59
1	0	1	1	1	0	0	mute

## 11.2.12 SUBADDRESS EH; TREBLE

**Table 50** Format of data byte EH with default setting

BIT 7	BIT 6	BIT 5	BIT 4	BIT 3	BIT 2	BIT 1	BIT 0
-	TRE2	TRE1	TRE0	TREM	TRF1	TRF0	-
-	0	0	0	1	0	1	-

**Table 51** Description of data byte EH, see Fig.20

BIT	SYMBOL	DESCRIPTION
7	-	Not used. Set to logic 0.
6 to 4	TRE[2:0]	<b>Treble gain.</b> See Table 52.
3	TREM	<b>Treble attenuation or gain.</b> 0 = attenuation; 1 = gain; see Table 52.
2 and 1	TRF[1:0]	<b>Treble frequency.</b> See Table 53.
0	-	Not used. Set to logic 0.

**Table 52** Treble gain

TRE2	TRE1	TRE0	TREM	TREBLE CONTROL (dB)
1	1	1	1	14
1	1	0	1	12
1	0	1	1	10
1	0	0	1	8
0	1	1	1	6
0	1	0	1	4
0	0	1	1	2
0	0	0	1	0
0	0	0	0	0
0	0	1	0	-2
0	1	0	0	-4
0	1	1	0	-6
1	0	0	0	-8
1	0	1	0	-10
1	1	0	0	-12
1	1	1	0	-14

Car radio integrated signal processor

TEF6890H

**Table 53** Treble frequency

TRF1	TRF0	TREBLE FREQUENCY (kHz)
0	0	8
0	1	10
1	0	12
1	1	15

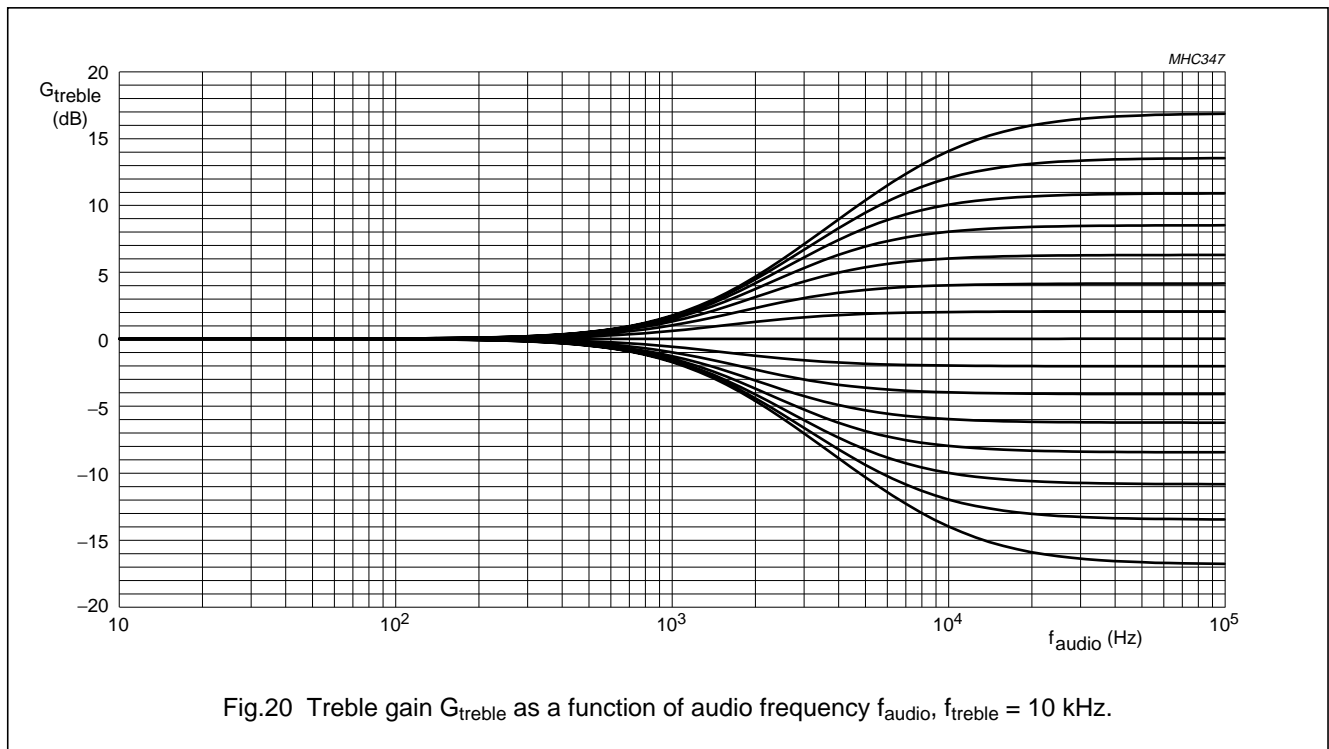

11.2.13 SUBADDRESS FH; BASS

**Table 54** Format of data byte FH with default setting

BIT 7	BIT 6	BIT 5	BIT 4	BIT 3	BIT 2	BIT 1	BIT 0
–	BAS2	BAS1	BAS0	BASM	BAF1	BAF0	BASH
–	0	0	0	1	1	0	0

**Table 55** Description of data byte FH, see Figs 21 and 22

BIT	SYMBOL	DESCRIPTION
7	–	Not used. Set to logic 0.
6 to 4	BAS[2:0]	<b>Bass gain.</b> See Table 56.
3	BASM	<b>Bass attenuation or gain.</b> 0 = attenuation; 1 = gain; see Table 56.
2 and 1	BAF[1:0]	<b>Bass frequency.</b> See Table 57.
0	BASH	<b>Bass frequency response.</b> 0 = band-pass; 1 = shelf curve (only guaranteed for BASM = 0).

Car radio integrated signal processor

TEF6890H

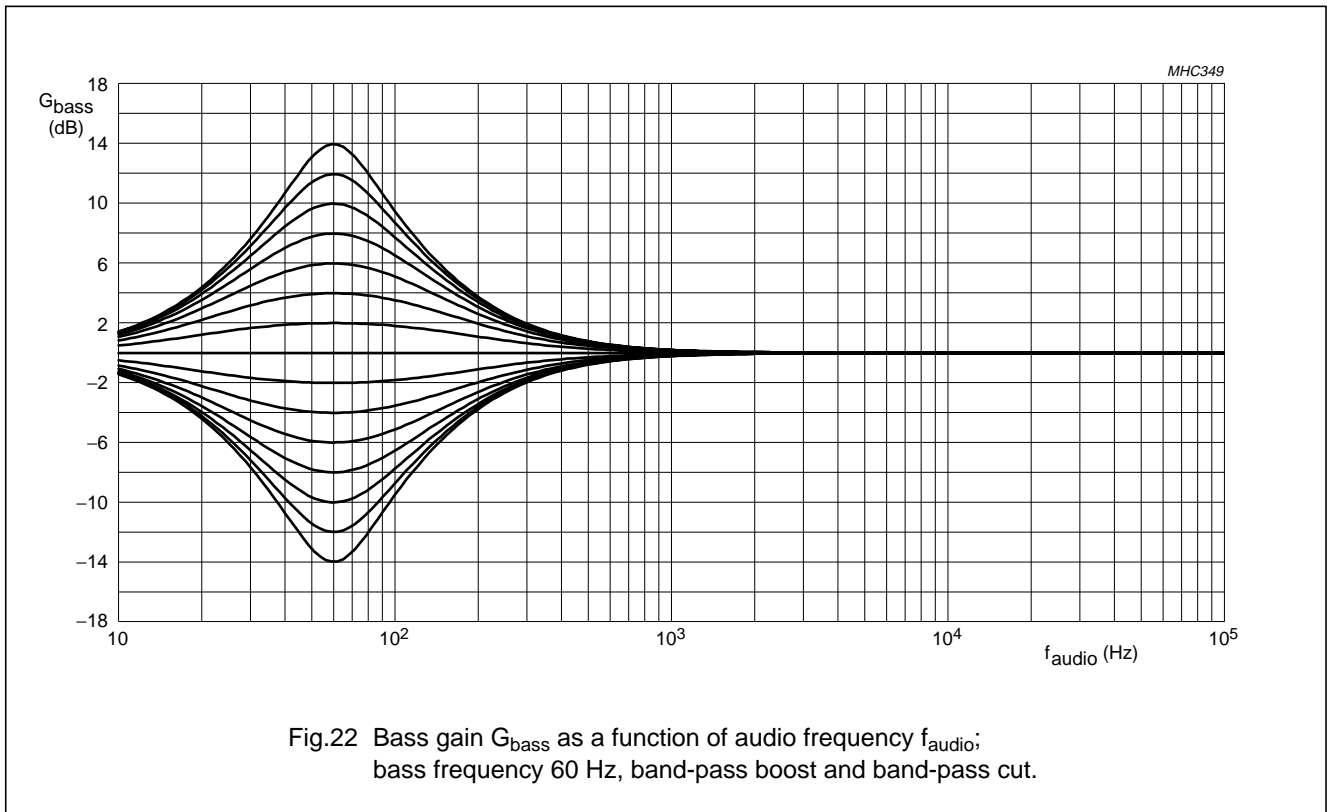
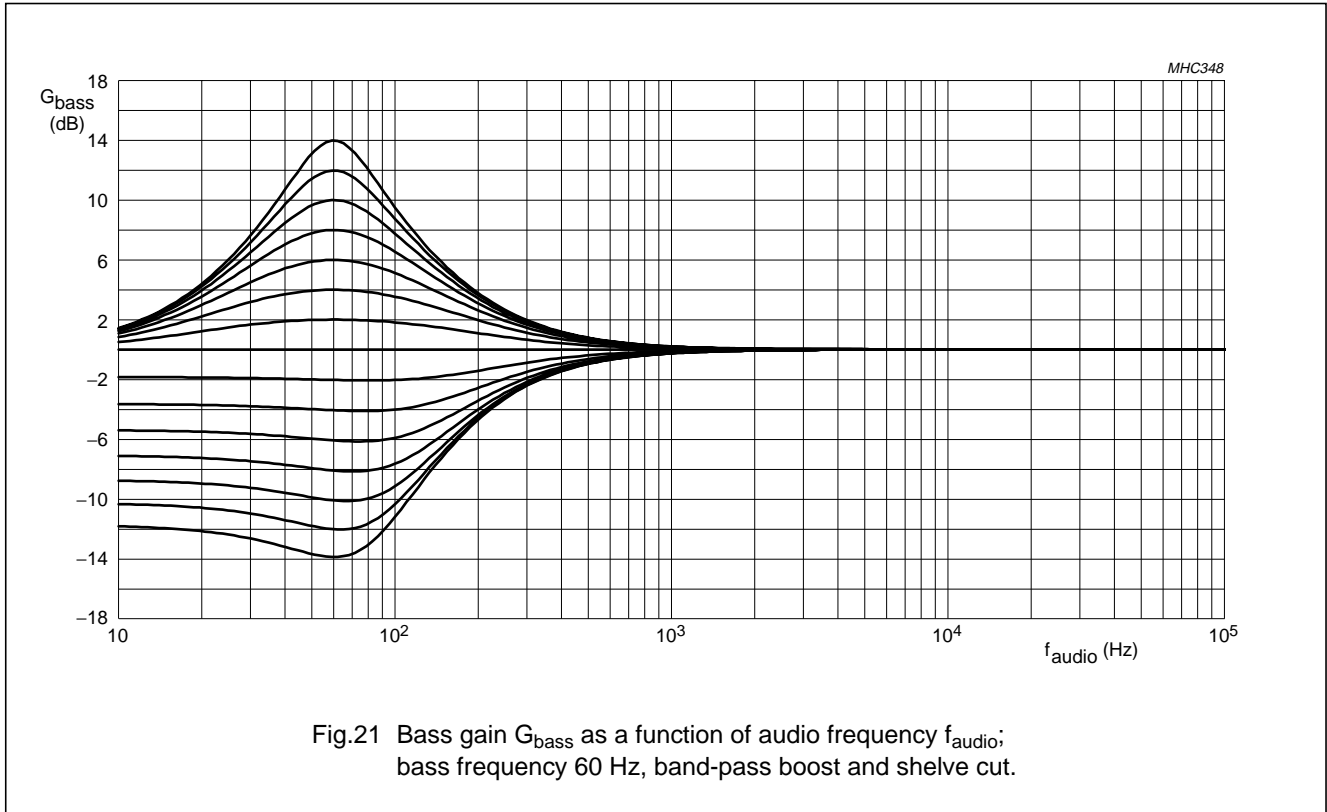

## Car radio integrated signal processor

TEF6890H

**Table 56** Bass gain

BAS2	BAS1	BAS0	BASM	BASS CONTROL (dB)
1	1	1	1	14
1	1	0	1	12
1	0	1	1	10
1	0	0	1	8
0	1	1	1	6
0	1	0	1	4
0	0	1	1	2
0	0	0	1	0
0	0	0	0	0
0	0	1	0	-2
0	1	0	0	-4
0	1	1	0	-6
1	0	0	0	-8
1	0	1	0	-10
1	1	0	0	-12
1	1	1	0	-14

**Table 57** Bass frequency

BAF1	BAF0	BASS FREQUENCY (Hz)
0	0	60
0	1	80
1	0	100
1	1	120

## 11.2.14 SUBADDRESS 10H; FADER

**Table 58** Format of data byte 10H with default setting

BIT 7	BIT 6	BIT 5	BIT 4	BIT 3	BIT 2	BIT 1	BIT 0
–	–	FAD4	FAD3	FAD2	FAD1	FAD0	FADM
–	–	0	0	0	0	0	1

**Table 59** Description of data byte 10H

BIT	SYMBOL	DESCRIPTION
7 and 6	–	Not used. Set to logic 0.
5 to 1	FAD[4:0]	<b>Fader gain.</b> See Table 60.
0	FADM	<b>Fader gain mode.</b> 0 = front output attenuated; 1 = rear output attenuated.

## Car radio integrated signal processor

TEF6890H

**Table 60** Fader gain

FAD4	FAD3	FAD2	FAD1	FAD0	FADER CONTROL (dB)
0	0	0	0	0	0
0	0	0	0	1	-1
0	0	0	1	0	-2
:	:	:	:	:	:
0	1	1	1	0	-14
0	1	1	1	1	-15
1	0	0	0	0	-17.5
1	0	0	0	1	-20
:	:	:	:	:	:
1	1	0	1	0	-42.5
1	1	0	1	1	-45
1	1	1	0	0	-48
1	1	1	0	1	-51
1	1	1	1	0	-55
1	1	1	1	1	-59

## 11.2.15 SUBADDRESS 11H; BALANCE

**Table 61** Format of data byte 11H with default setting

BIT 7	BIT 6	BIT 5	BIT 4	BIT 3	BIT 2	BIT 1	BIT 0
BAL6	BAL5	BAL4	BAL3	BAL2	BAL1	BAL0	BALM
0	0	0	0	0	0	0	1

**Table 62** Description of data byte 11H

BIT	SYMBOL	DESCRIPTION
7 to 1	BAL[6:0]	<b>Balance gain.</b> See Table 63.
0	BALM	<b>Balance gain mode.</b> 0 = left channel attenuated; 1 = right channel attenuated.

**Table 63** Balance gain

BAL6	BAL5	BAL4	BAL3	BAL2	BAL1	BAL0	BALANCE CONTROL (dB)
0	0	0	0	0	0	0	0
0	0	0	0	0	0	1	-1
0	0	0	0	0	1	0	-2
:	:	:	:	:	:	:	:
1	0	0	1	1	0	1	-77
1	0	0	1	1	1	0	-78
1	0	0	1	1	1	1	-79
1	0	1	0	0	0	0	mute

## Car radio integrated signal processor

TEF6890H

## 11.2.16 SUBADDRESS 12H; MIX

**Table 64** Format of data byte 12H with default setting

BIT 7	BIT 6	BIT 5	BIT 4	BIT 3	BIT 2	BIT 1	BIT 0
MILF	MIRF	MILR	MIRR	MULF	MURF	MULR	MURR
0	0	0	0	1	1	1	1

**Table 65** Description of data byte 12H

BIT	SYMBOL	DESCRIPTION
7	MILF	<b>Mixer left front LFOUT.</b> 0 = no mix; 1 = mix with NAV input and BEEP.
6	MIRF	<b>Mixer right front RFOUT.</b> 0 = no mix; 1 = mix with NAV input and BEEP.
5	MILR	<b>Mixer left rear LROUT.</b> 0 = no mix; 1 = mix with NAV input and BEEP.
4	MIRR	<b>Mixer right rear RROUT.</b> 0 = no mix; 1 = mix with NAV input and BEEP.
3	MULF	<b>Mutes left front LFOUT.</b> 0 = no mute; 1 = mute except for NAV input and BEEP.
2	MURF	<b>Mutes right front RFOUT.</b> 0 = no mute; 1 = mute except for NAV input and BEEP.
1	MULR	<b>Mutes left rear LROUT.</b> 0 = no mute; 1 = mute except for NAV input and BEEP.
0	MURR	<b>Mutes right rear RROUT.</b> 0 = no mute; 1 = mute except for NAV input and BEEP.

## 11.2.17 SUBADDRESS 13H; BEEP

**Table 66** Format of data byte 13H with default setting

BIT 7	BIT 6	BIT 5	BIT 4	BIT 3	BIT 2	BIT 1	BIT 0
BEL2	BEL1	BEL0	BEF1	BEF0	NAV	–	–
0	0	0	0	0	0	–	–

**Table 67** Description of data byte 13H

BIT	SYMBOL	DESCRIPTION
7 to 5	BEL[2:0]	<b>Beep level.</b> See Table 68.
4 and 3	BEF[1:0]	<b>Beep frequency.</b> See Table 69.
2	NAV	<b>Mute NAV.</b> 0 = mute; 1 = no mute.
1 and 0	–	Not used. Set to logic 0.

**Table 68** Beep level

BEL2	BEL1	BEL0	BEEP LEVEL (mV)
0	0	0	mute
0	0	1	13
0	1	0	18
0	1	1	28
1	0	0	44
1	0	1	60
1	1	0	90
1	1	1	150

## Car radio integrated signal processor

TEF6890H

**Table 69** Beep frequency

BEF1	BEF0	BEEP FREQUENCY (Hz)
0	0	500
0	1	1000
1	0	2000
1	1	3000

## 11.2.18 SUBADDRESS 1FH; AUTOGATE

**Table 70** Format of data byte 1FH with default setting

BIT 7	BIT 6	BIT 5	BIT 4	BIT 3	BIT 2	BIT 1	BIT 0
AGA6	AGA5	AGA4	AGA3	AGA2	AGA1	AGA0	AGOF
–	–	–	–	–	–	–	1

**Table 71** Description of data byte 1FH

BIT	SYMBOL	DESCRIPTION
7 to 1	AGA[6:0]	<b>I<sup>2</sup>C-bus device address definition.</b> These bits define the I <sup>2</sup> C-bus device address definition for the automatic control of the I <sup>2</sup> C-bus loop through gate. The subaddress auto-increment function reverts from SA = 30 to SA = 0, excluding the AUTOGATE byte (SA = 31). The AUTOGATE byte can only be accessed via direct subaddress selection of SA = 31, in which case auto-increment will revert to SA = 0.
0	AGOF	<b>Autogate function enable.</b> 0 = enable; 1 = disable [The autogate function is not compatible with the TEA684x tuner devices. For the TEA684x the use of the shortgate (SGAT) function is advised].

Car radio integrated signal processor

TEF6890H

12 TEST AND APPLICATION INFORMATION

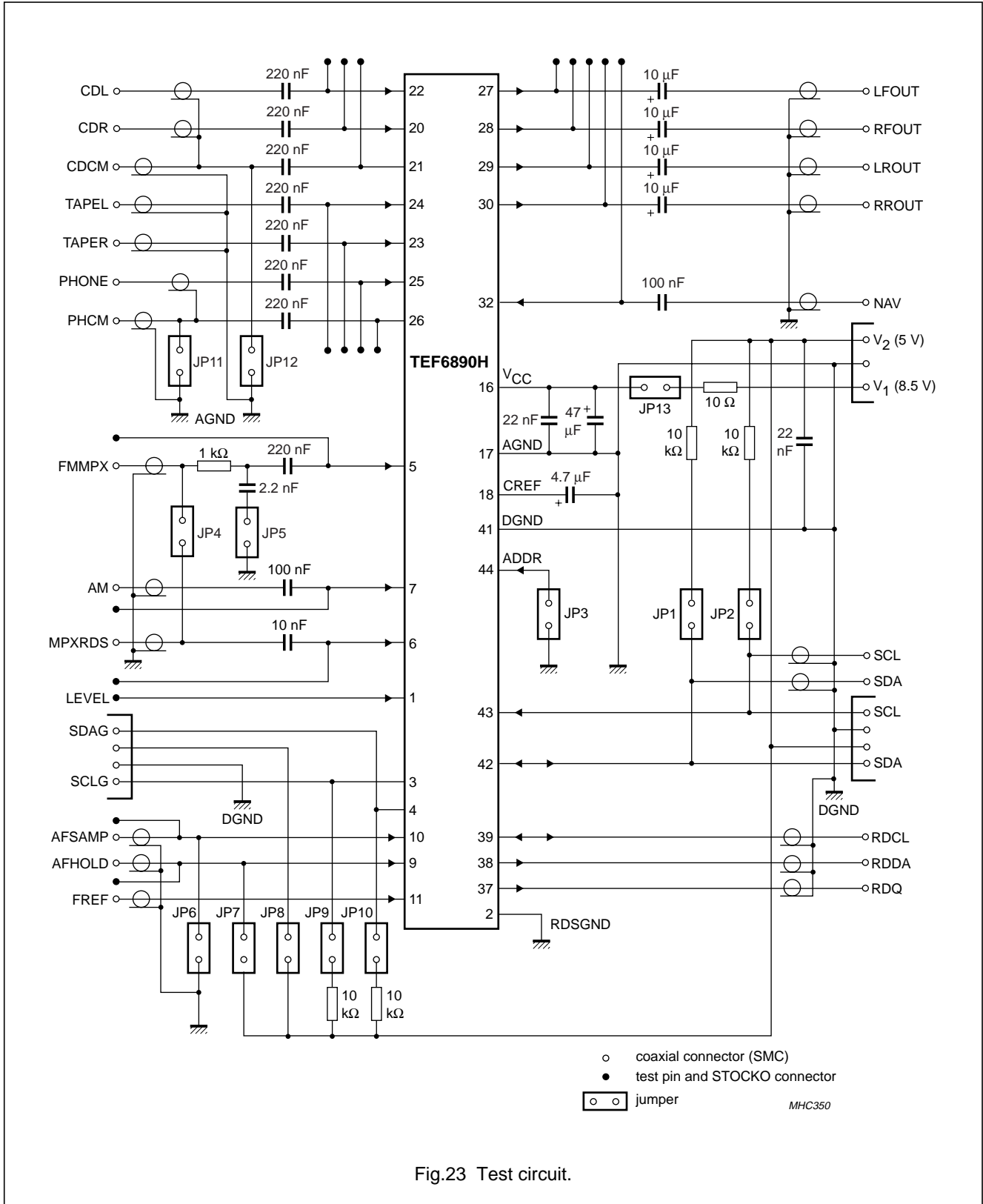

Fig.23 Test circuit.



Car radio integrated signal processor

TEF6890H

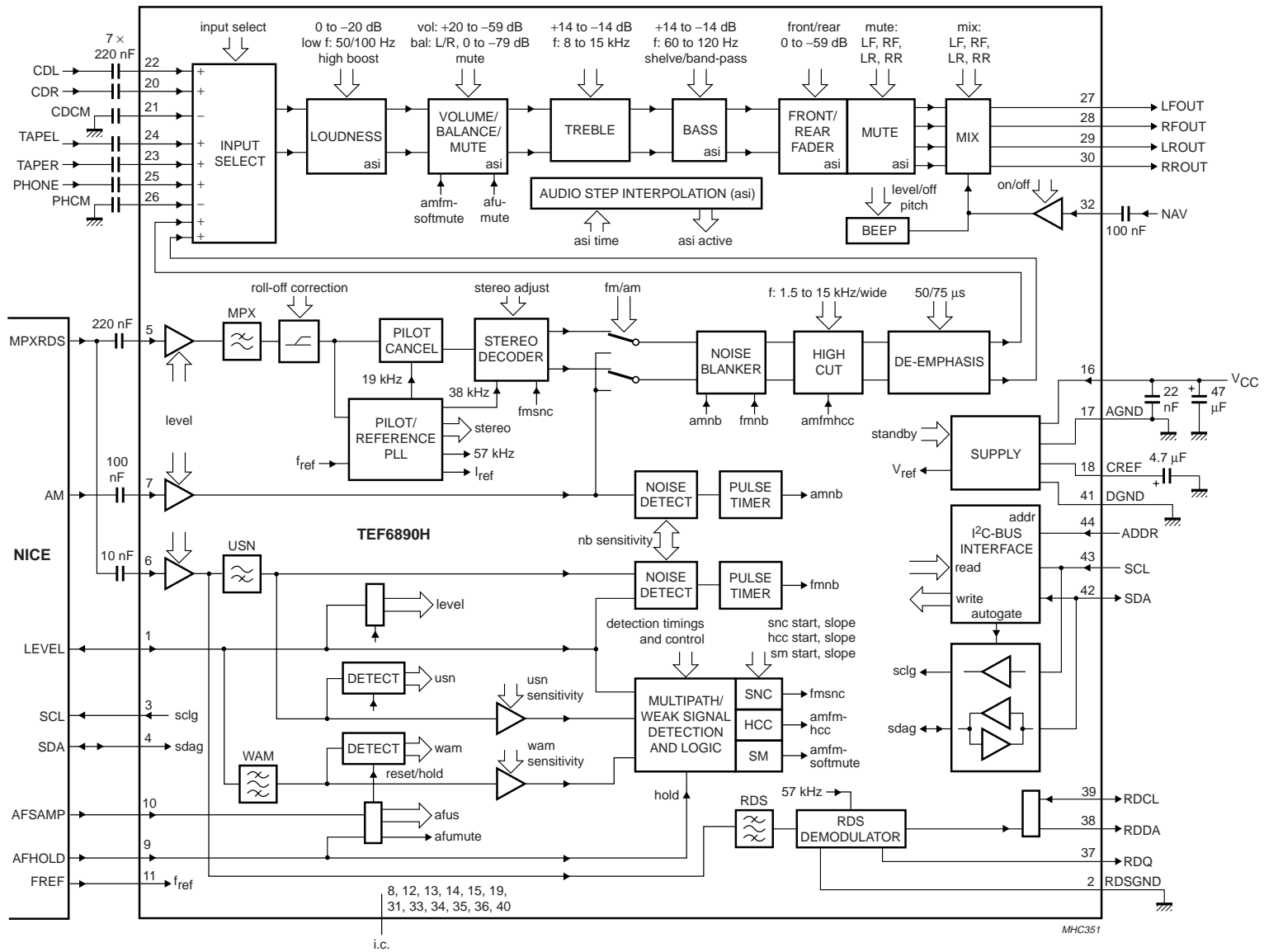

Fig.24 Application diagram.

Car radio integrated signal processor

TEF6890H

13 PACKAGE OUTLINE

QFP44: plastic quad flat package; 44 leads (lead length 1.3 mm); body 10 x 10 x 1.75 mm

SOT307-2

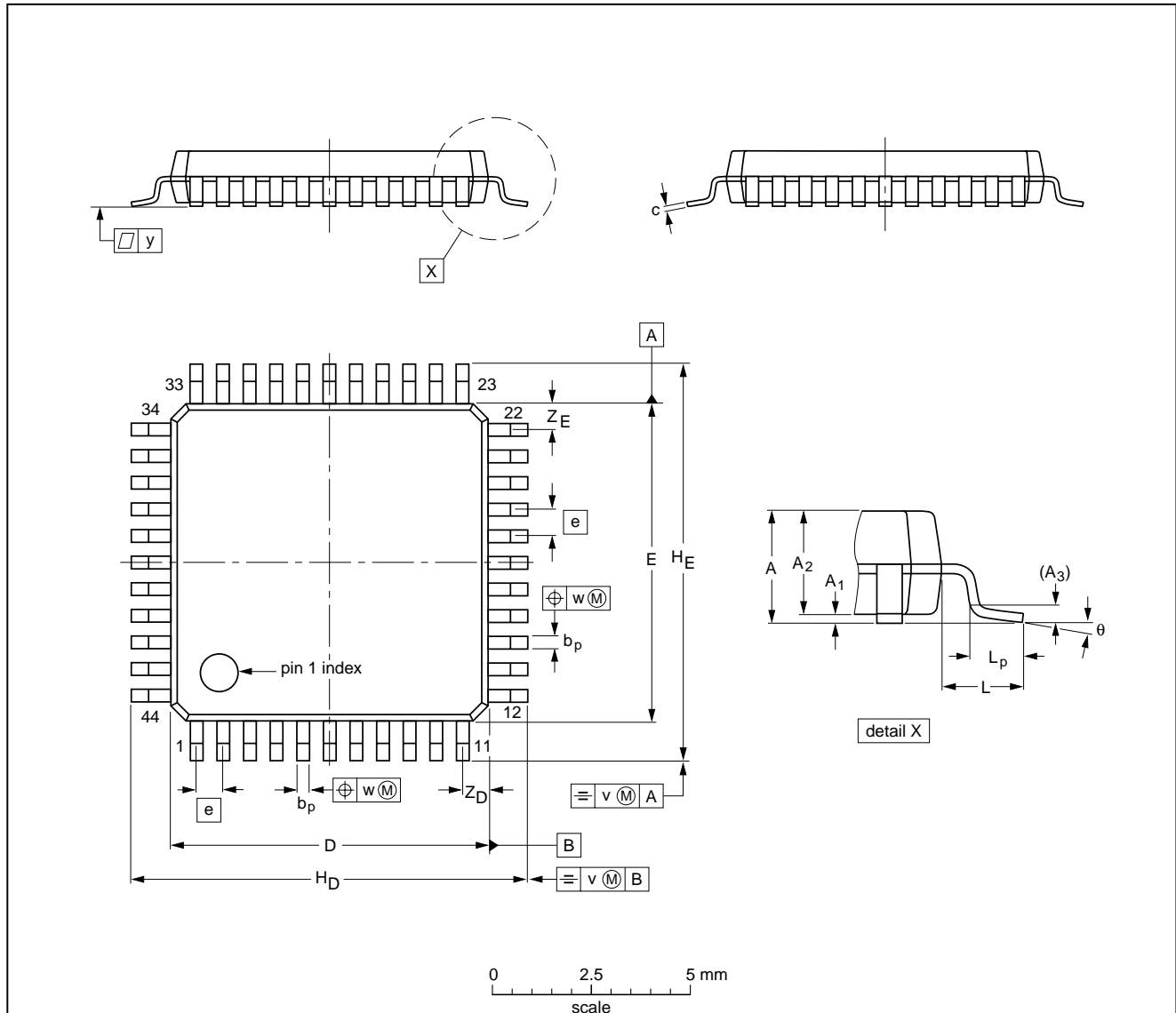

DIMENSIONS (mm are the original dimensions)

UNIT	A max.	A <sub>1</sub>	A <sub>2</sub>	A <sub>3</sub>	b <sub>p</sub>	c	D <sup>(1)</sup>	E <sup>(1)</sup>	e	H <sub>D</sub>	H <sub>E</sub>	L	L <sub>p</sub>	v	w	y	Z <sub>D</sub> <sup>(1)</sup>	Z <sub>E</sub> <sup>(1)</sup>	θ
mm	2.1	0.25 0.05	1.85 1.65	0.25	0.4 0.2	0.25 0.14	10.1 9.9	10.1 9.9	0.8	12.9 12.3	12.9 12.3	1.3	0.95 0.55	0.15	0.15	0.1	1.2 0.8	1.2 0.8	10° 0°

Note  
1. Plastic or metal protrusions of 0.25 mm maximum per side are not included.

OUTLINE VERSION	REFERENCES				EUROPEAN PROJECTION	ISSUE DATE
	IEC	JEDEC	JEITA			
SOT307-2						97-08-01 03-02-25

## Car radio integrated signal processor

TEF6890H

### 14 SOLDERING

#### 14.1 Introduction to soldering surface mount packages

This text gives a very brief insight to a complex technology. A more in-depth account of soldering ICs can be found in our *"Data Handbook IC26; Integrated Circuit Packages"* (document order number 9398 652 90011).

There is no soldering method that is ideal for all surface mount IC packages. Wave soldering can still be used for certain surface mount ICs, but it is not suitable for fine pitch SMDs. In these situations reflow soldering is recommended.

#### 14.2 Reflow soldering

Reflow soldering requires solder paste (a suspension of fine solder particles, flux and binding agent) to be applied to the printed-circuit board by screen printing, stencilling or pressure-syringe dispensing before package placement. Driven by legislation and environmental forces the worldwide use of lead-free solder pastes is increasing.

Several methods exist for reflowing; for example, convection or convection/infrared heating in a conveyor type oven. Throughput times (preheating, soldering and cooling) vary between 100 and 200 seconds depending on heating method.

Typical reflow peak temperatures range from 215 to 270 °C depending on solder paste material. The top-surface temperature of the packages should preferably be kept:

- below 225 °C (SnPb process) or below 245 °C (Pb-free process)
  - for all BGA and SSOP-T packages
  - for packages with a thickness  $\geq 2.5$  mm
  - for packages with a thickness  $< 2.5$  mm and a volume  $\geq 350$  mm<sup>3</sup> so called thick/large packages.
- below 240 °C (SnPb process) or below 260 °C (Pb-free process) for packages with a thickness  $< 2.5$  mm and a volume  $< 350$  mm<sup>3</sup> so called small/thin packages.

Moisture sensitivity precautions, as indicated on packing, must be respected at all times.

#### 14.3 Wave soldering

Conventional single wave soldering is not recommended for surface mount devices (SMDs) or printed-circuit boards with a high component density, as solder bridging and non-wetting can present major problems.

To overcome these problems the double-wave soldering method was specifically developed.

If wave soldering is used the following conditions must be observed for optimal results:

- Use a double-wave soldering method comprising a turbulent wave with high upward pressure followed by a smooth laminar wave.
- For packages with leads on two sides and a pitch (e):
  - larger than or equal to 1.27 mm, the footprint longitudinal axis is **preferred** to be parallel to the transport direction of the printed-circuit board;
  - smaller than 1.27 mm, the footprint longitudinal axis **must** be parallel to the transport direction of the printed-circuit board.

The footprint must incorporate solder thieves at the downstream end.

- For packages with leads on four sides, the footprint must be placed at a 45° angle to the transport direction of the printed-circuit board. The footprint must incorporate solder thieves downstream and at the side corners.

During placement and before soldering, the package must be fixed with a droplet of adhesive. The adhesive can be applied by screen printing, pin transfer or syringe dispensing. The package can be soldered after the adhesive is cured.

Typical dwell time of the leads in the wave ranges from 3 to 4 seconds at 250 °C or 265 °C, depending on solder material applied, SnPb or Pb-free respectively.

A mildly-activated flux will eliminate the need for removal of corrosive residues in most applications.

#### 14.4 Manual soldering

Fix the component by first soldering two diagonally-opposite end leads. Use a low voltage (24 V or less) soldering iron applied to the flat part of the lead. Contact time must be limited to 10 seconds at up to 300 °C.

When using a dedicated tool, all other leads can be soldered in one operation within 2 to 5 seconds between 270 and 320 °C.

## Car radio integrated signal processor

TEF6890H

## 14.5 Suitability of surface mount IC packages for wave and reflow soldering methods

PACKAGE <sup>(1)</sup>	SOLDERING METHOD	
	WAVE	REFLOW <sup>(2)</sup>
BGA, LBGA, LFBGA, SQFP, SSOP-T <sup>(3)</sup> , TFBGA, VFBGA	not suitable	suitable
DHVQFN, HBCC, HBGA, HLQFP, HSQFP, HSOP, HTQFP, HTSSOP, HVQFN, HVSON, SMS	not suitable <sup>(4)</sup>	suitable
PLCC <sup>(5)</sup> , SO, SOJ	suitable	suitable
LQFP, QFP, TQFP	not recommended <sup>(5)(6)</sup>	suitable
SSOP, TSSOP, VSO, VSSOP	not recommended <sup>(7)</sup>	suitable
PMFP <sup>(8)</sup>	not suitable	not suitable

## Notes

- For more detailed information on the BGA packages refer to the “(LF)BGA Application Note” (AN01026); order a copy from your Philips Semiconductors sales office.
- All surface mount (SMD) packages are moisture sensitive. Depending upon the moisture content, the maximum temperature (with respect to time) and body size of the package, there is a risk that internal or external package cracks may occur due to vaporization of the moisture in them (the so called popcorn effect). For details, refer to the Drypack information in the “Data Handbook IC26; Integrated Circuit Packages; Section: Packing Methods”.
- These transparent plastic packages are extremely sensitive to reflow soldering conditions and must on no account be processed through more than one soldering cycle or subjected to infrared reflow soldering with peak temperature exceeding  $217\text{ °C} \pm 10\text{ °C}$  measured in the atmosphere of the reflow oven. The package body peak temperature must be kept as low as possible.
- These packages are not suitable for wave soldering. On versions with the heatsink on the bottom side, the solder cannot penetrate between the printed-circuit board and the heatsink. On versions with the heatsink on the top side, the solder might be deposited on the heatsink surface.
- If wave soldering is considered, then the package must be placed at a  $45^\circ$  angle to the solder wave direction. The package footprint must incorporate solder thieves downstream and at the side corners.
- Wave soldering is suitable for LQFP, TQFP and QFP packages with a pitch (e) larger than 0.8 mm; it is definitely not suitable for packages with a pitch (e) equal to or smaller than 0.65 mm.
- Wave soldering is suitable for SSOP, TSSOP, VSO and VSSOP packages with a pitch (e) equal to or larger than 0.65 mm; it is definitely not suitable for packages with a pitch (e) equal to or smaller than 0.5 mm.
- Hot bar or manual soldering is suitable for PMFP packages.

## Car radio integrated signal processor

TEF6890H

## 15 DATA SHEET STATUS

LEVEL	DATA SHEET STATUS <sup>(1)</sup>	PRODUCT STATUS <sup>(2)(3)</sup>	DEFINITION
I	Objective data	Development	This data sheet contains data from the objective specification for product development. Philips Semiconductors reserves the right to change the specification in any manner without notice.
II	Preliminary data	Qualification	This data sheet contains data from the preliminary specification. Supplementary data will be published at a later date. Philips Semiconductors reserves the right to change the specification without notice, in order to improve the design and supply the best possible product.
III	Product data	Production	This data sheet contains data from the product specification. Philips Semiconductors reserves the right to make changes at any time in order to improve the design, manufacturing and supply. Relevant changes will be communicated via a Customer Product/Process Change Notification (CPCN).

## Notes

1. Please consult the most recently issued data sheet before initiating or completing a design.
2. The product status of the device(s) described in this data sheet may have changed since this data sheet was published. The latest information is available on the Internet at URL <http://www.semiconductors.philips.com>.
3. For data sheets describing multiple type numbers, the highest-level product status determines the data sheet status.

## 16 DEFINITIONS

**Short-form specification** — The data in a short-form specification is extracted from a full data sheet with the same type number and title. For detailed information see the relevant data sheet or data handbook.

**Limiting values definition** — Limiting values given are in accordance with the Absolute Maximum Rating System (IEC 60134). Stress above one or more of the limiting values may cause permanent damage to the device. These are stress ratings only and operation of the device at these or at any other conditions above those given in the Characteristics sections of the specification is not implied. Exposure to limiting values for extended periods may affect device reliability.

**Application information** — Applications that are described herein for any of these products are for illustrative purposes only. Philips Semiconductors make no representation or warranty that such applications will be suitable for the specified use without further testing or modification.

## 17 DISCLAIMERS

**Life support applications** — These products are not designed for use in life support appliances, devices, or systems where malfunction of these products can reasonably be expected to result in personal injury. Philips Semiconductors customers using or selling these products for use in such applications do so at their own risk and agree to fully indemnify Philips Semiconductors for any damages resulting from such application.

**Right to make changes** — Philips Semiconductors reserves the right to make changes in the products - including circuits, standard cells, and/or software - described or contained herein in order to improve design and/or performance. When the product is in full production (status 'Production'), relevant changes will be communicated via a Customer Product/Process Change Notification (CPCN). Philips Semiconductors assumes no responsibility or liability for the use of any of these products, conveys no licence or title under any patent, copyright, or mask work right to these products, and makes no representations or warranties that these products are free from patent, copyright, or mask work right infringement, unless otherwise specified.

---

**Car radio integrated signal processor****TEF6890H**

---

**18 PURCHASE OF PHILIPS I<sup>2</sup>C COMPONENTS**

Purchase of Philips I<sup>2</sup>C components conveys a license under the Philips' I<sup>2</sup>C patent to use the components in the I<sup>2</sup>C system provided the system conforms to the I<sup>2</sup>C specification defined by Philips. This specification can be ordered using the code 9398 393 40011.

# ***Philips Semiconductors – a worldwide company***

## **Contact information**

For additional information please visit <http://www.semiconductors.philips.com>. Fax: +31 40 27 24825

For sales offices addresses send e-mail to: [sales.addresses@www.semiconductors.philips.com](mailto:sales.addresses@www.semiconductors.philips.com).

© Koninklijke Philips Electronics N.V. 2003

SCA75

All rights are reserved. Reproduction in whole or in part is prohibited without the prior written consent of the copyright owner.

The information presented in this document does not form part of any quotation or contract, is believed to be accurate and reliable and may be changed without notice. No liability will be accepted by the publisher for any consequence of its use. Publication thereof does not convey nor imply any license under patent- or other industrial or intellectual property rights.

Printed in The Netherlands

753503/01/pp55

Date of release: 2003 Oct 21

Document order number: 9397 750 10356

*Let's make things better.*

**Philips  
Semiconductors**



**PHILIPS**