

ABSOLUTE MAXIMUM RATING

Symbol	Parameter	Value	Unit
HV _C	Collector Voltage (Internally Limited)	-0.3 to V _{clamp}	V
I _C	Collector Current (Internally Limited)	10	A
I _{C(gnd)}	DC Current on Emitter Power	± 10.5 (*)	A
V _{CC}	Driving Stage Supply Voltage	-0.3 to 7	V
I _S	Driving Circuitry Supply Current	± 200	mA
I _{S(gnd)}	DC Current on Ground Pin	± 1	A
V _{in}	Input Voltage	-0.3 to V _{CC} + 0.3	V
I _{in}	Maximum Input Current	100	mA
f _{in}	Logic Input Frequency in Operative Mode	DC to 150	Hz
V _{out(flag)}	Output Voltage Primary Threshold Current Level	-0.3 to V _{CC} + 0.3	V
I _{out(flag)}	Flag Output Current	100	mA
P _{max}	Power Dissipation (T _C = 105 °C)	TBD	W
E _{s/b}	Clamped Energy During Output Power Clamping	300	mJ
V _{ESD}	ESD Voltage (HVC Pin)	± 4	KV
V _{ESD}	ESD Voltage (Other Pins)	± 2	KV
I _{BD}	Input Darlington Base Current	150	mA
V _{BD}	Input Darlington Base Voltage	Internally Limited	V
T _j	Operating Junction Temperature	-40 to 150	°C
T _{stg}	Storage Temperature Range	-55 to 150	°C

(*) With 10 mils Al wire

THERMAL DATA

R _{thj-case}	Thermal Resistance Junction Case (MAX)	1.2	°C/W
R _{thj-h}	Thermal Resistance Junction Heatsink with FR4 (MAX)	TBD (★)	°C/W
T _{sold}	Lead Temperature During Soldering (MAX)	TBD (★)	°C

(★) see application note AN515/1094 on VIPower data-book 1st edition.

CONNECTION DIAGRAM

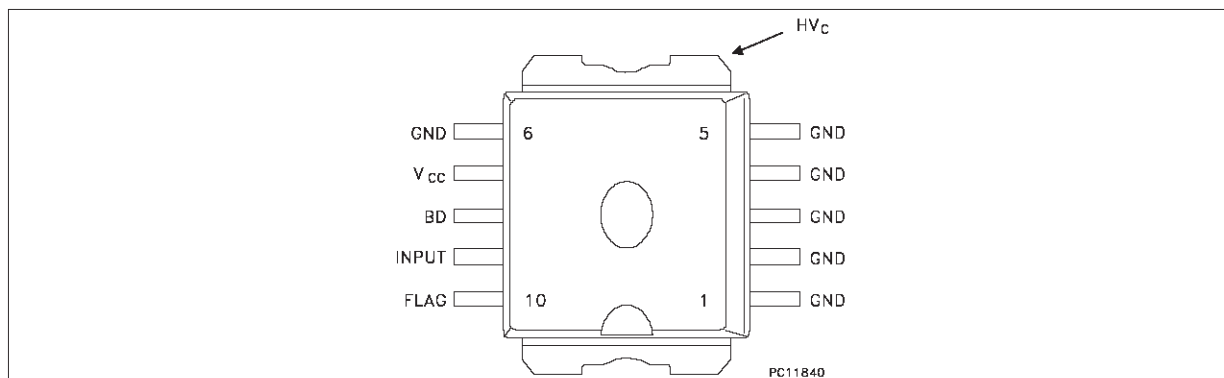

PIN FUNCTION

No	NAME	FUNCTION
1-5	GND	Emitter Power Ground
6	GND	Control Ground (*)
7	V _{CC}	Logic Supply Voltage
8	BD	Base Darlington
9	INPUT	Logic Input Channel (Internal Pull Down)
10	FLAG	Diagnostic Output Signal (Open Emitter)
TAB	HVC	Primary Coil Output Driver (Open Collector)

(*) Pin 6 must be connected to pins 1-5 externally

ELECTRICAL CHARACTERISTICS ($5.3V < V_b < 24V$; $V_{CC} = 5V \pm 10\%$; $-40^{\circ}C < T_j < 125^{\circ}C$;
 $R_{coil} = 580\ m\Omega$; $L_{coil} = 3.75\ mH$; unless otherwise specified; see note 1)

Symbol	Parameter	Test Conditions	Min.	Typ.	Max.	Unit
V _{Cl}	High Voltage Clamp	I _{coil} = 6.5 A	320	380	420	V
V _{ce(sat)}	Saturation Voltage of The Power Stage	I _c = 7.5A; V _{in} = 4V			TBD	V
I _{CC(stbby)}	Stand-by Supply Current	IN = OFF			10	mA
I _{CC}	DC Logic Current	V _b = 16 V I _c = 6.5 A f = 100 Hz Load = Coil V _{CC} = 5.5V			40	mA
I _{CC(peak)}	Peak DC Logic Current During On Phase	I _c = 7.5 A (see figure 1)			TBD	mA
V _{CC}	DC Logic Voltage		4.5		5.5	V
I _{Cl}	Coil Current Limit	-40°C < T _j < 125°C (see note 2 and figure 1)	9		11	A
I _{C(leak)}	Output leakage Current	IN = OFF V _{HVC} = 24V			0.8	mA
I _{C(infl)}	Collector Current with Floating Input	V _{CC} = 5 V V _{Bat} = 13.5 V R _{LOAD} = 1KΩ; Input Floating			0.8	mA
T _{Ic_ctr}	Thermal Temperature Output Current Control	OUT = ON (see figure 2)	150		(*)	°C
V _{inH}	High Level Input Voltage	V _{CC} = 4.5V	4		V _{CC}	V
V _{inL}	Low Level Input Voltage	V _{CC} = 5.5V	-0.3		0.8	V

ELECTRICAL CHARACTERISTICS (continued)

Symbol	Parameter	Test Conditions	Min.	Typ.	Max.	Unit
$V_{in(hys)}$	Input Threshold Hysteresis		0.4			V
I_{inH}	High Level Input Current	$V_{in} = 4\text{ V}$			100	μA
I_{inL}	Low Level Input Current	$V_{in} = 0.8\text{ V}$			-100	μA
I_{inpd}	Input Active Pull-Down	$V_{in} = 4\text{ V}$	10		100	μA
V_{diagH}	High Level Flag Output Voltage	$R_{EXT} = 22\text{ K}\Omega$ $C_{EXT} = 1\text{ nF}$ (see note 3)	$V_{CC}-1$		V_{CC}	V
V_{diagL}	Low Level Flag Output Voltage	$R_{EXT} = 22\text{ K}\Omega$ $C_{EXT} = 1\text{ nF}$ (see note 3)			0.5	V
I_{diagTH}	Coil Current Level Threshold	$T_j = 25^\circ\text{C}$ (see figure 1)	4.25	4.5	4.75	A
I_{diagTD}	Coil Current Level Threshold Drift	(see figure 3)				
I_{diag}	High Level Flag Output Current	$I_C > I_{diagTH}$ $V_{diag} = 3\text{ V}$	0.5	TBD		mA
$I_{diag(leak)}$	Leakage Current On Flag Output	$V_{in} = \text{LOW}$ $V_{CC} = 5.5\text{V}$			10	μA
V_F	Antiparallel Diode Forward Voltage	$I_C = -1\text{ A}$			2	V
$E_{s/b}$	Single Pulse Avalanche Energy	$L = 6\text{ mH}$ $I_C = 8\text{ A}$ (see figure 4)	180			mJ
t_{pHL}	Turn-on Delay Time of Coil Current	$R_C = 0.5\ \Omega$ $L_C = 3.75\text{ mH}$ (see figure 5)		TBD		μs
t_{pLH}	Turn-off Delay Time of Coil Current	$R_C = 0.5\ \Omega$ $L_C = 3.75\text{ mH}$ $I_C = 6.5\text{A}$ (see figure 5)		TBD		μs

Note 1: Parametric degradation are allowed with $5.3 < V_b < 10\text{V}$ and $V_b > 24\text{V}$.

Note 2: The primary coil current value I_{cl} must be measured 1ms after desaturation of the power stage.

Note 3: No Internal Pull-Down

(*) Internally limited

PRINCIPLE OF OPERATION

The VB025BSP is mainly intended as a high voltage power switch device driven by a logic level input and interfaces directly to a high energy electronic ignition coil.

The input V_{in} of the VB025BSP is fed from a low power signal generated by an external controller that determines both dwell time and ignition point. During V_{in} high ($\geq 4\text{V}$) the VB025BSP increases current in the coil to the desired, internally set current level.

After reaching this level, the coil current remains constant until the ignition point, that corresponds to the transition of V_{in} from high to low (typ. 1.9V threshold).

During the coil current switch-off, the primary

voltage HV_C is clamped at an internally set value V_{cl} , typically 380V.

The transition from saturation to desaturation, coil current limiting phase, must have the ability to accommodate an overvoltage. A maximum overshoot of 20V is allowed.

FEEDBACK

When the collector current exceeds 4.5A, the feedback signal is turned high and it remains so, until the input voltage is turned-off.

OVERVOLTAGE

The VB025BSP can withstand the following transients of the battery line:

-100V/2msec ($R_i = 10\ \Omega$)

+100V/0.2msec ($R_i = 10\ \Omega$)

+50V/400msec ($R_i = 4.2\ \Omega$, with $V_{IN} = 3\text{ V}$)

Fig. 1 Main Waveforms During On Phase

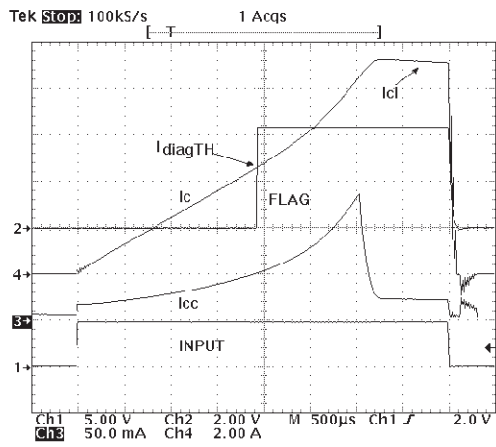

Fig. 2 Output Current Waveform After Thermal Protection Activation

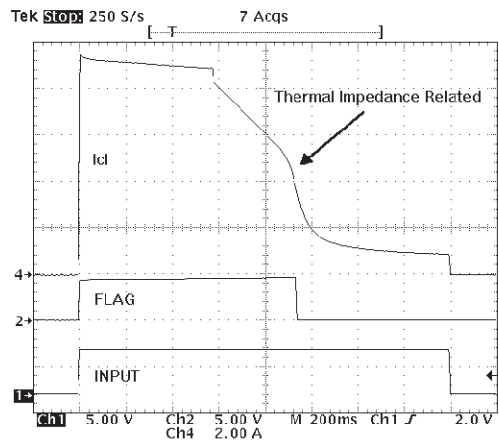

Fig. 3 Flag Current Versus Temperature

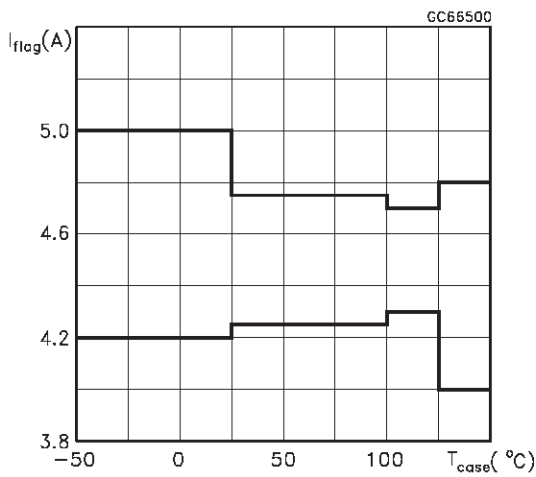

FIG. 4 Single Pulse Typical E_s/b Curve

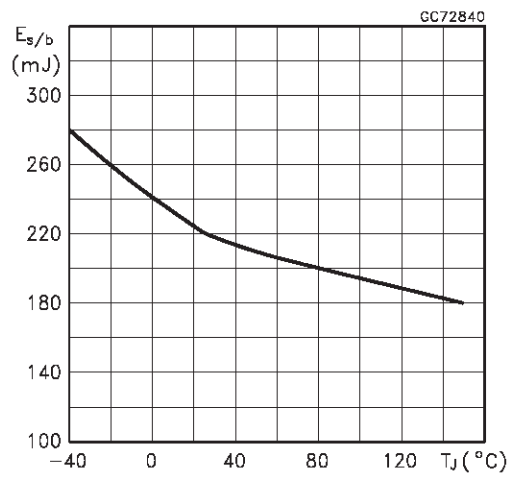
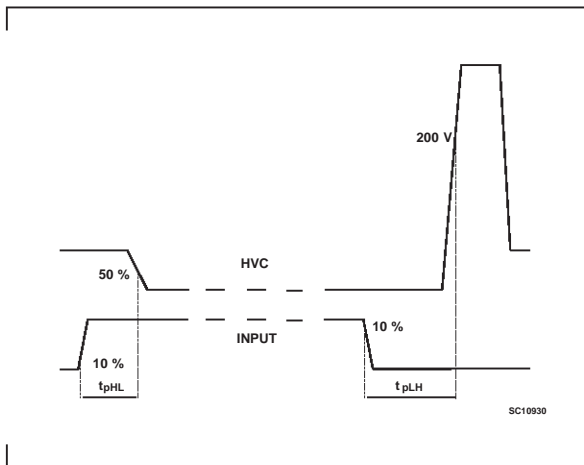
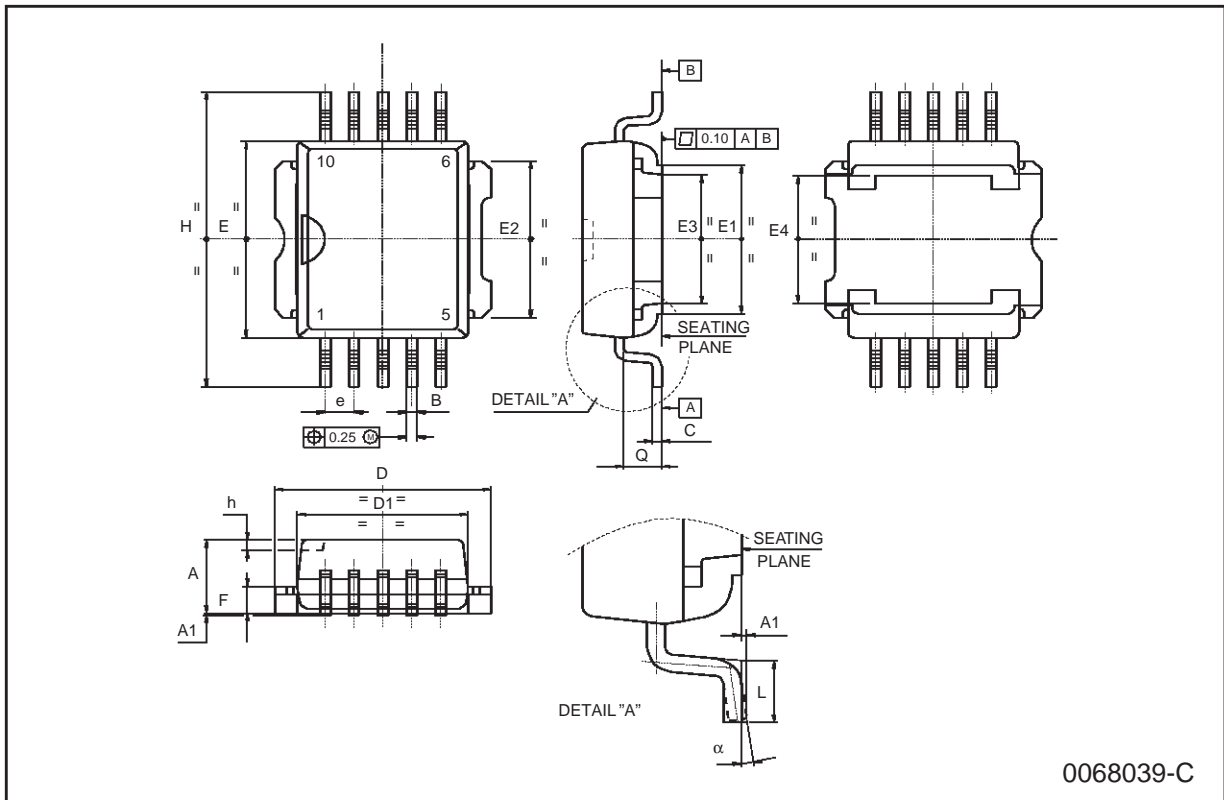

FIG. 5 Propagation Times Definitions.



PowerSO-10 MECHANICAL DATA

DIM.	mm			inch		
	MIN.	TYP.	MAX.	MIN.	TYP.	MAX.
A	3.35		3.65	0.132		0.144
A1	0.00		0.10	0.000		0.004
B	0.40		0.60	0.016		0.024
c	0.35		0.55	0.013		0.022
D	9.40		9.60	0.370		0.378
D1	7.40		7.60	0.291		0.300
E	9.30		9.50	0.366		0.374
E1	7.20		7.40	0.283		0.291
E2	7.20		7.60	0.283		0.300
E3	6.10		6.35	0.240		0.250
E4	5.90		6.10	0.232		0.240
e		1.27			0.050	
F	1.25		1.35	0.049		0.053
H	13.80		14.40	0.543		0.567
h		0.50			0.002	
L	1.20		1.80	0.047		0.071
q		1.70			0.067	
α	0°		8°			



0068039-C

Information furnished is believed to be accurate and reliable. However, STMicroelectronics assumes no responsibility for the consequences of use of such information nor for any infringement of patents or other rights of third parties which may result from its use. No license is granted by implication or otherwise under any patent or patent rights of STMicroelectronics. Specification mentioned in this publication are subject to change without notice. This publication supersedes and replaces all information previously supplied. STMicroelectronics products are not authorized for use as critical components in life support devices or systems without express written approval of STMicroelectronics.

The ST logo is a trademark of STMicroelectronics

© 1999 STMicroelectronics – Printed in Italy – All Rights Reserved

STMicroelectronics GROUP OF COMPANIES

Australia - Brazil - Canada - China - France - Germany - Italy - Japan - Korea - Malaysia - Malta - Mexico - Morocco - The Netherlands - Singapore - Spain - Sweden - Switzerland - Taiwan - Thailand - United Kingdom - U.S.A.

<http://www.st.com>

