

	No.3364	<h2 style="margin: 0;">2SB1468/2SD2219</h2> <p style="margin: 0;">PNP/NPN Epitaxial Planar Silicon Transistors</p> <p style="margin: 0;">30V/8A High-Speed Switching Applications</p>
--	---------	---

Applications

- Relay drivers, high-speed inverters, converters, etc.

Features

- Micaless package facilitating mounting
- Low collector-to-emitter saturation voltage : $V_{CE(sat)} = -0.5V(\text{PNP}), 0.4V(\text{NPN})$ max.
- Large current capacity

() : 2SB1468

Absolute Maximum Ratings at $T_a = 25^\circ\text{C}$

			unit
Collector-to-Base Voltage	V_{CB0}	(-)60	V
Collector-to-Emitter Voltage	V_{CE0}	(-)30	V
Emitter-to-Base Voltage	V_{EB0}	(-)6	V
Collector Current	I_C	(-)12	A
Collector Current (Pulse)	I_{CP}	(-)20	A
Collector Dissipation	P_C	2	W
		25	W
		150	$^\circ\text{C}$
Junction Temperature	T_j	-55 to +150	$^\circ\text{C}$
Storage Temperature	T_{stg}		

$T_c = 25^\circ\text{C}$

Electrical Characteristics at $T_a = 25^\circ\text{C}$

		min	typ	max
Collector Cutoff Current	I_{CB0} $V_{CB} = (-)40V, I_E = 0$			(-)0.1 mA
Emitter Cutoff Current	I_{EB0} $V_{EB} = (-)4V, I_C = 0$			(-)0.1 mA
DC Current Gain	$h_{FE(1)}$ $V_{CE} = (-)2V, I_C = (-)1A$	70*		280*
	$h_{FE(2)}$ $V_{CE} = (-)2V, I_C = (-)6A$	30		
Gain-Bandwidth Product	f_T $V_{CE} = (-)5V, I_C = (-)1A$		120	MHz
C-E Saturation Voltage	$V_{CE(sat)}$ $I_C = (-)5A, I_B = (-)0.25A$			(-0.5) V
				0.4 V
C-B Breakdown Voltage	$V_{(BR)CBO}$ $I_C = (-)1mA, I_E = 0$	(-)60		V
C-E Breakdown Voltage	$V_{(BR)CEO}$ $I_C = (-)1mA, R_{BE} = \infty$	(-)30		V
E-B Breakdown Voltage	$V_{(BR)EBO}$ $I_E = (-)1mA, I_C = 0$	(-)6		V
Turn-ON time	t_{on} See specified Test Circuit.	(0.1)0.2		μs
Storage Time	t_{stg} Same as above.	(0.3)0.5		μs
Fall Time	t_f Same as above.	0.03		μs

* : The 2SB1468/2SD2219 are classified by 1A h_{FE} as follows :

70 Q 140	100 R 200	140 S 280
----------	-----------	-----------

Switching Time Test Circuit

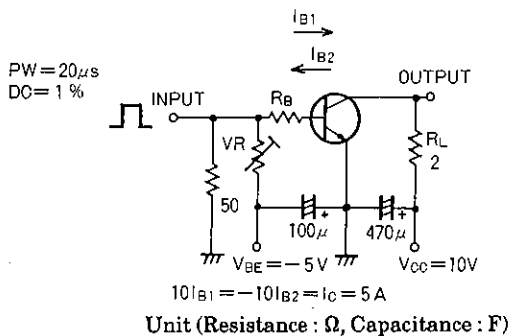

Package Dimensions 2041

(unit : mm)

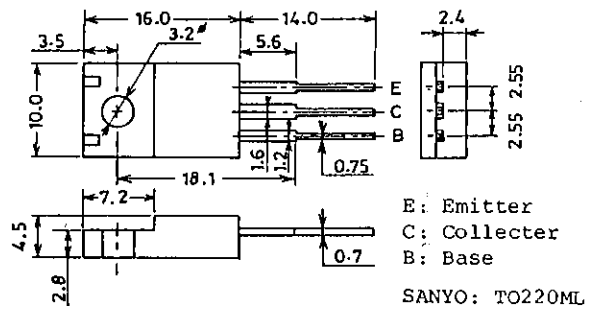

2SB1468/2SD2219

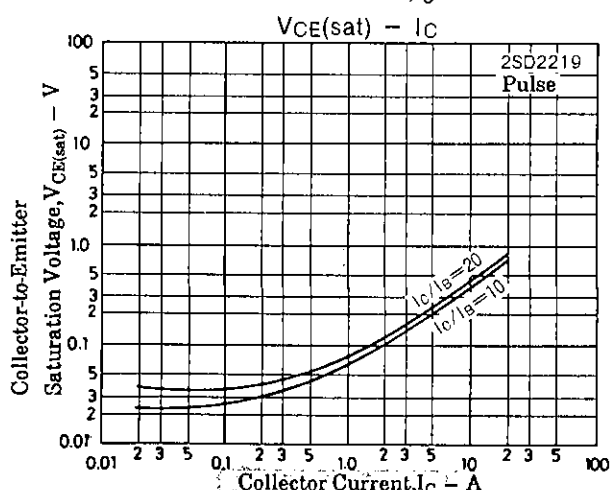
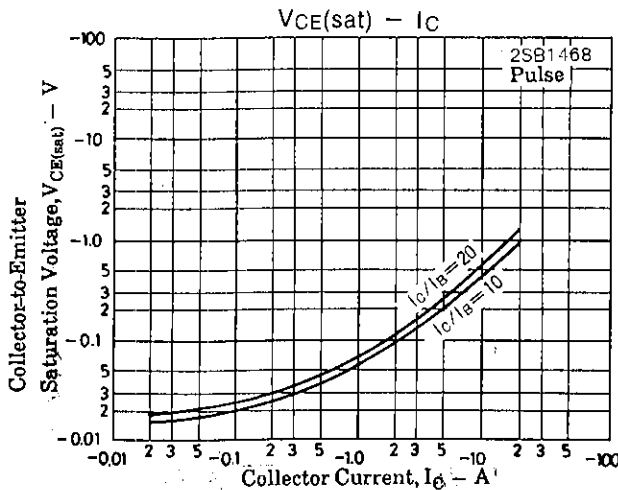
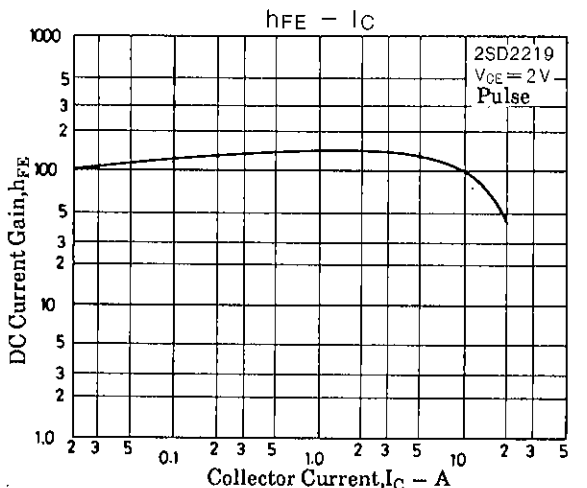
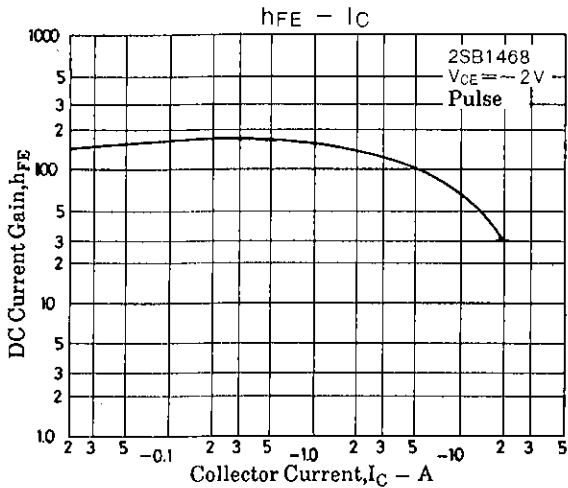
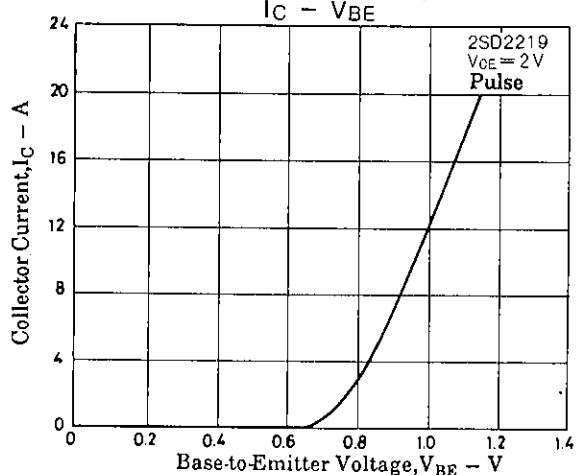
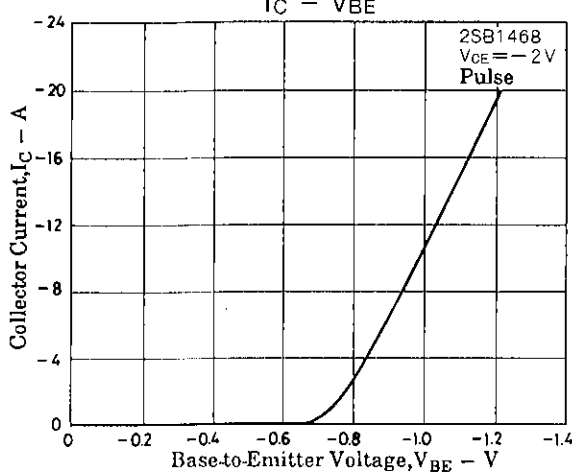
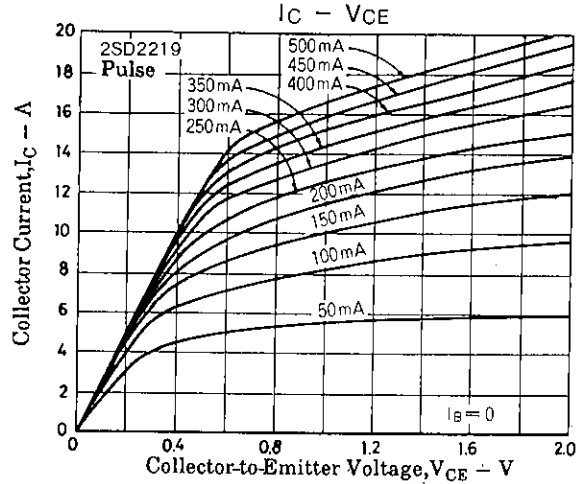
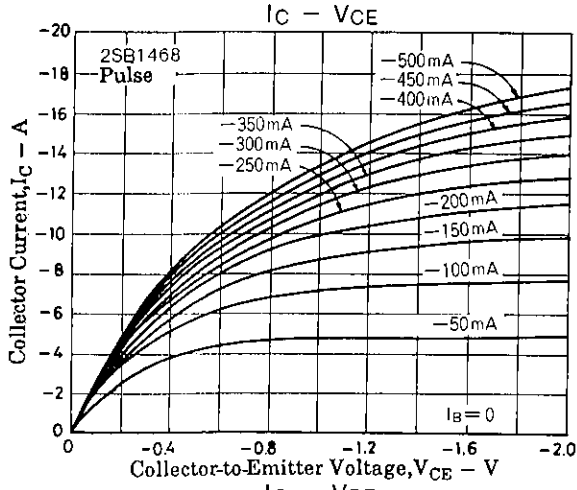

2SB1468/2SD2219

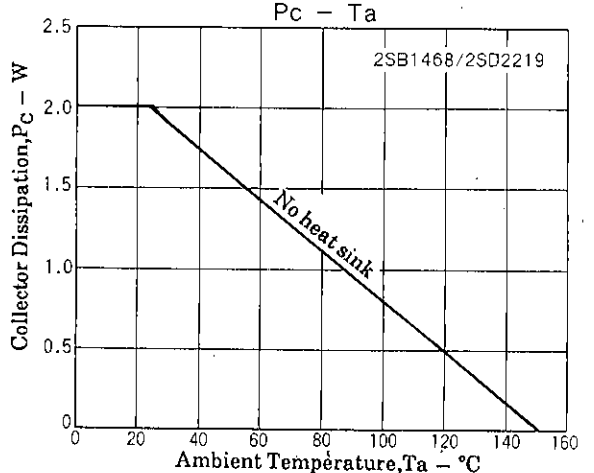
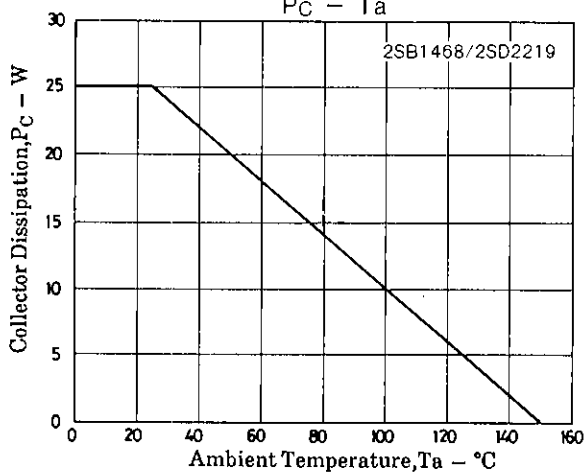
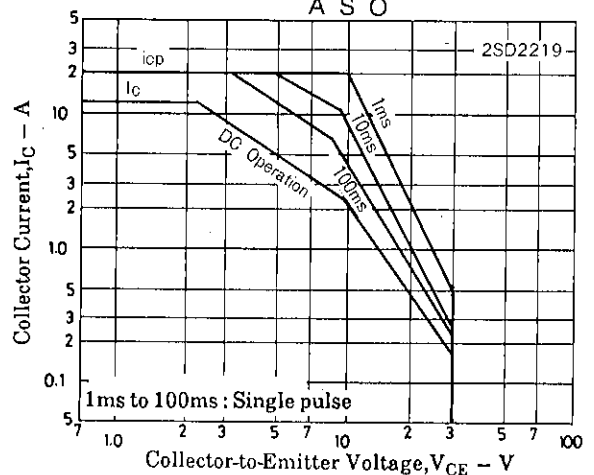
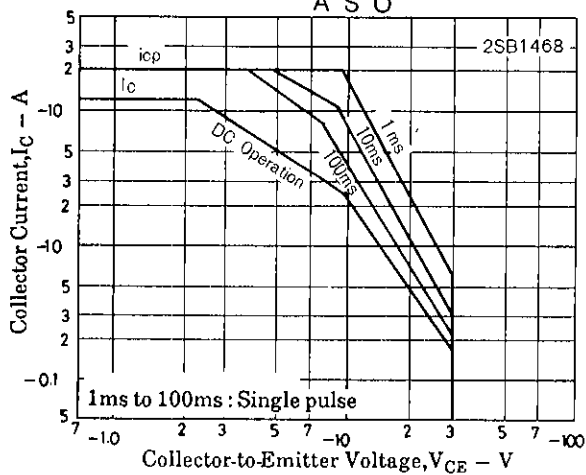
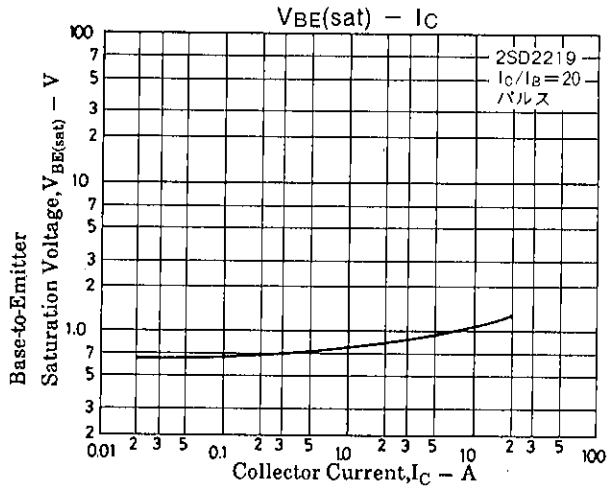
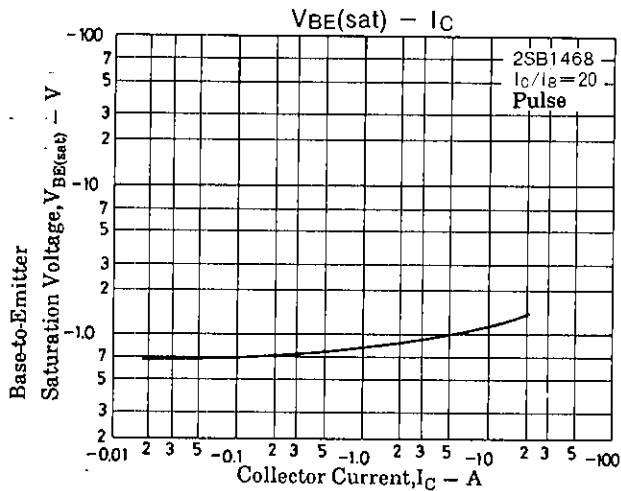

■ No products described or contained herein are intended for use in surgical implants, life-support systems, aerospace equipment, nuclear power control systems, vehicles, disaster/crime-prevention equipment and the like, the failure of which may directly or indirectly cause injury, death or property loss.

■ Anyone purchasing any products described or contained herein for an above-mentioned use shall:

- ① Accept full responsibility and indemnify and defend SANYO ELECTRIC CO., LTD., its affiliates, subsidiaries and distributors and all their officers and employees, jointly and severally, against any and all claims and litigation and all damages, cost and expenses associated with such use.
- ② Not impose any responsibility for any fault or negligence which may be cited in any such claim or litigation on SANYO ELECTRIC CO., LTD., its affiliates, subsidiaries and distributors or any of their officers and employees jointly or severally.

■ Information (including circuit diagrams and circuit parameters) herein is for example only; it is not guaranteed for volume production. SANYO believes information herein is accurate and reliable, but no guarantees are made or implied regarding its use or any infringements of intellectual property rights or other rights of third parties.