

240 126
to
240-242

Trim Trio Interconnection System

SMS-QIKMATE Connectors

Description

The versatile SMS QIKMATE connectors offer economy to meet the constant demand for more cost-effective interconnection techniques. They are available as self mountable receptacles, plugs, boardmounts, P.C. pin headers and accessories.

Features and benefits

- Self mountable receptacle with positive housing retention.
- Error-free mating with positive connector polarization.
- Plugs with retaining latches for positive locking.
- Plugs with pin protection skirt to prevent damage of male contacts.
- Boardmounts available with stamped and formed or solid machined contacts.

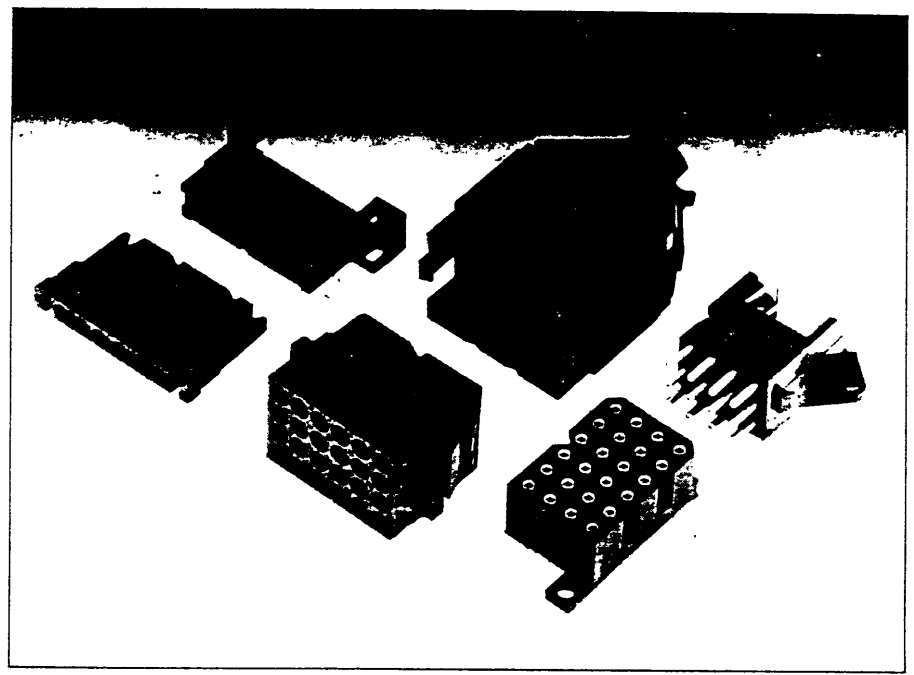

Performance characteristics

Operating temperature	: -55 °C to +105 °C
Insulation resistance	: 5000 MΩmin.
Test potential	: 2000 VAC
Current rating boardmount	: 5 Amp
Contact resistance boardmount	: ≤ 6 mΩ
Durability	: 500 cycles

Construction

Plugs, receptacles, pin headers and accessories : Polyamide 6,6
 P.C. Board Receptacle : Glass-reinforced thermoplastic
 Contacts: High conductivity copper alloy
 Plating boardmounts:
 - No digit = std 0,4 μ Gold min over Nickel
 - J = Gold flash over Nickel
 - T = 3-5 μ Tin
 - S6 = 0,75 μ Gold min selective over Nickel
 - D70 = Gold flash over Nickel
 - TK6 = Tin alloy preplated

Contact accommodation

SMS QIKMATE Plug and receptacle connectors accept TRIM TRIO crimp type removable snap-lock contacts.

1. No. 16 machined contacts type RM / RC for wire sizes from 0,05 to 1,50 mm².
2. Type RMDX / RCDX contacts for subminiature coaxial and twisted pair wires.
3. No. 16 stripfeed contacts type SM / SC for wire sizes from 0,05 to 1,50 mm² or for wire size AWG 16, 20 and 24.

- Contacts to be ordered separately, see datasheet No 2-110, 2-111, 2-112, 2-113, 2-114.
 - Boardmounts have pre-assembled contacts.

How to order QIKMATE Plugs and Receptacles

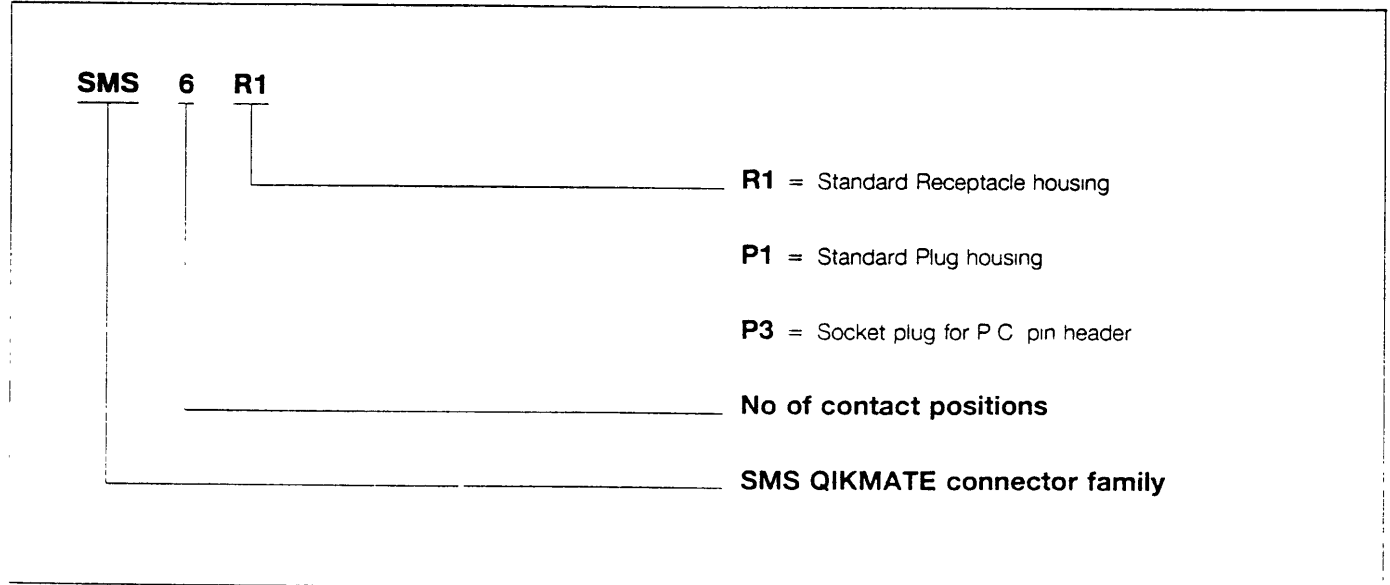

How to order QIKMATE Boardmounts straight and right-angle

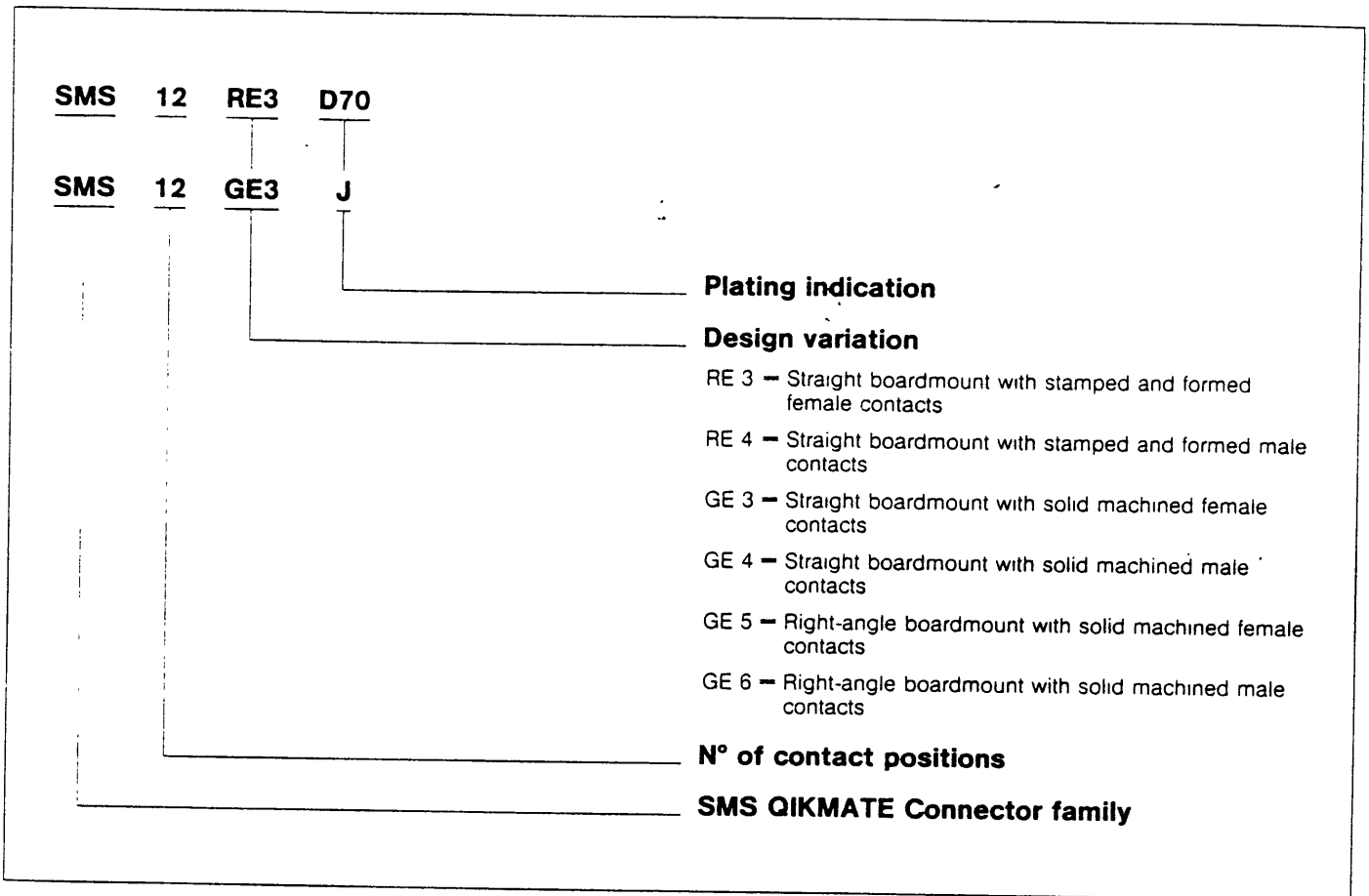

How to order QIKMATE P.C. Pin Headers

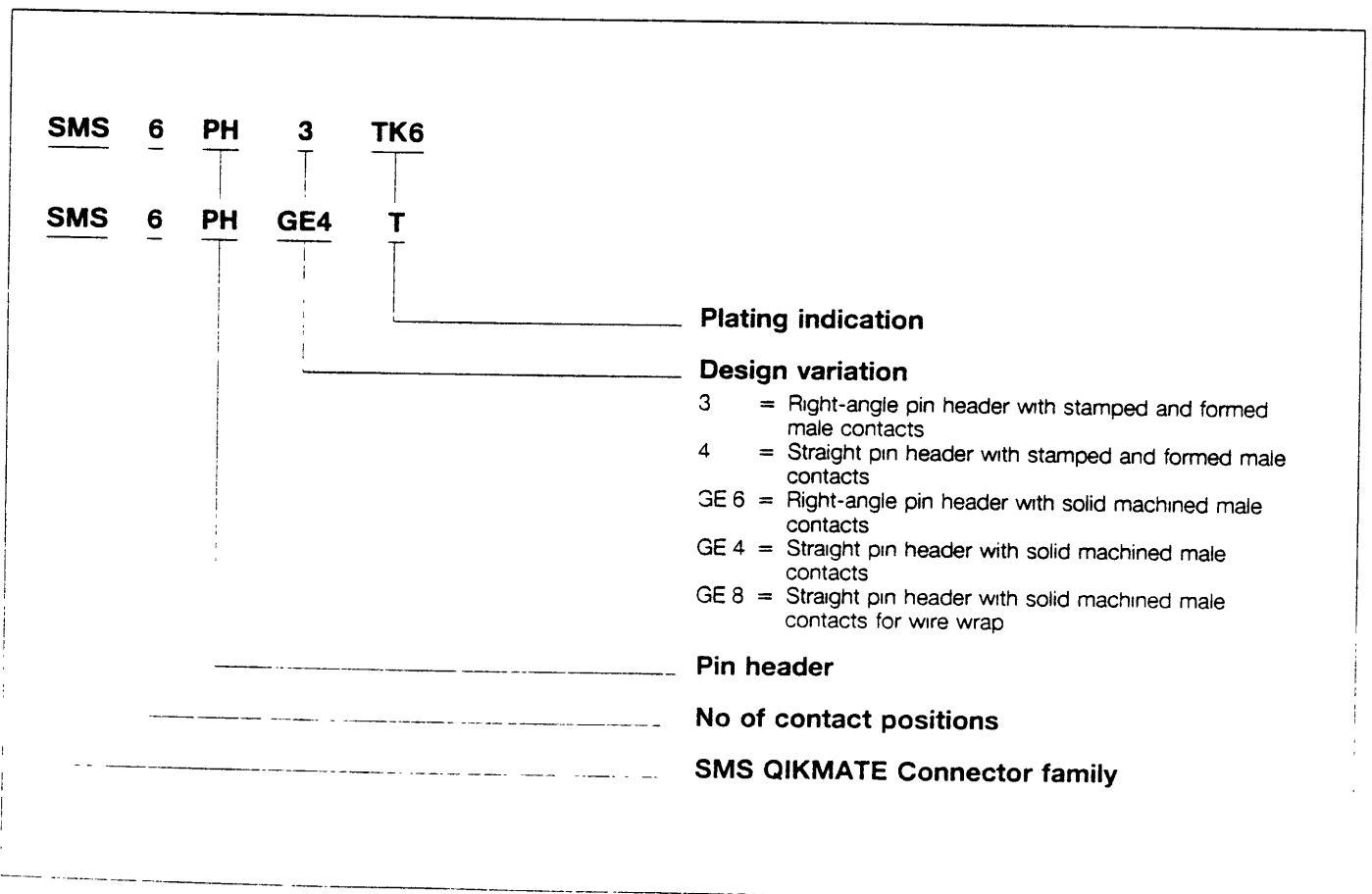

Contact Identification

2 position

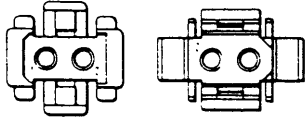

Plug

Receptacle

3 position

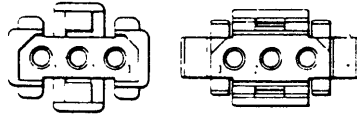

Plug

Receptacle

4 position

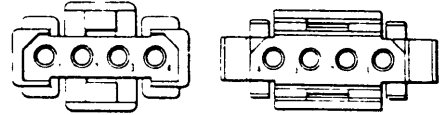

Plug

Receptacle

6 position

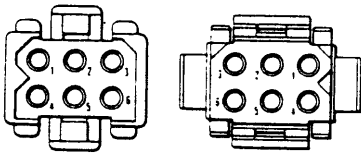

Plug

Receptacle

9 position

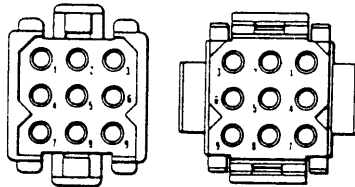

Plug

Receptacle

12 position

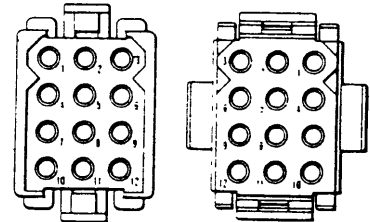

Plug

Receptacle

15 position

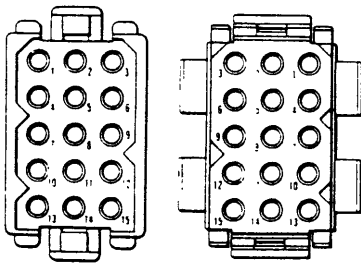

Plug

Receptacle

18 position

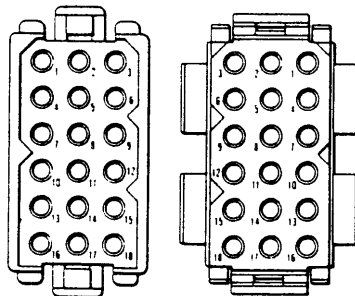

Plug

Receptacle

24 position

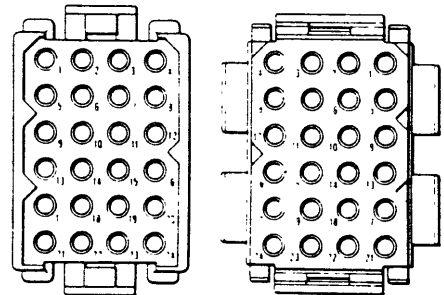

Plug

Receptacle

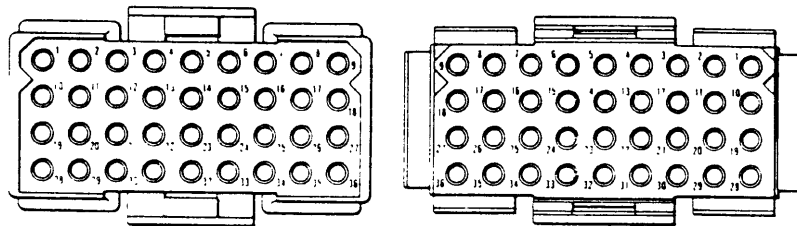

Plug

Receptacle

36 position

Standard Connectors

Plugs SMS..P

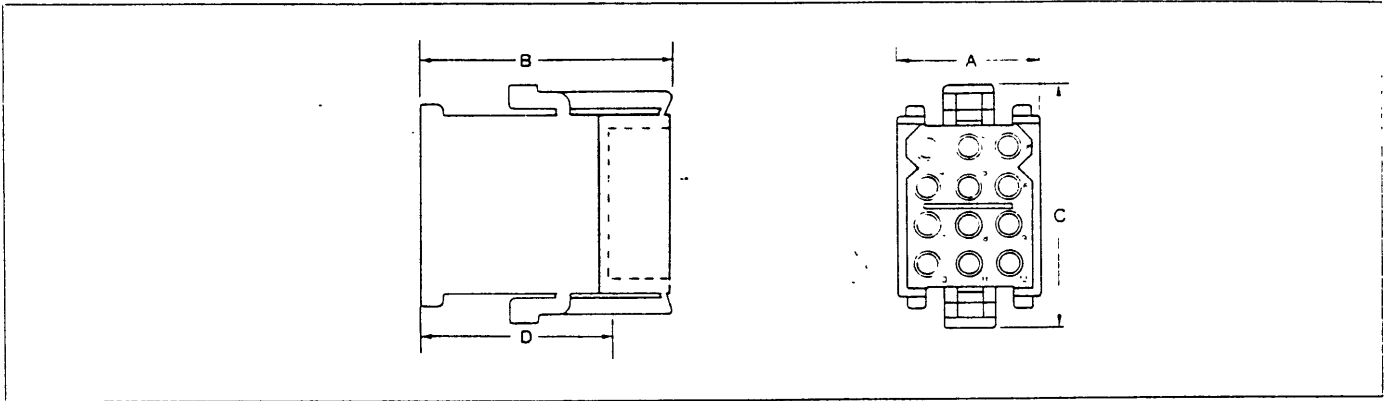

N° of positions	Catalogue number	Dimensions in mm			
		A	B	C max.	D
2	SMS 2 P 1	15,0	32,8	17,8	24,9
3	SMS 3 P 1*	18,5	32,8	17,8	24,9
4	SMS 4 P 1	23,6	32,8	17,8	24,9
6	SMS 6 P 1*	18,5	32,8	22,9	24,9
9	SMS 9 P 1	18,5	32,8	27,9	24,9
12	SMS 12 P 1*	18,5	32,8	33,0	24,9
15	SMS 15 P 1	18,5	32,8	38,1	24,9
18	SMS 18 P 1	18,5	32,8	43,2	24,9
24	SMS 24 P 1*	23,6	32,8	43,2	24,9
36	SMS 36 P 1*	49,0	32,8	33,0	24,9

* Standard item

Receptacles SMS..R

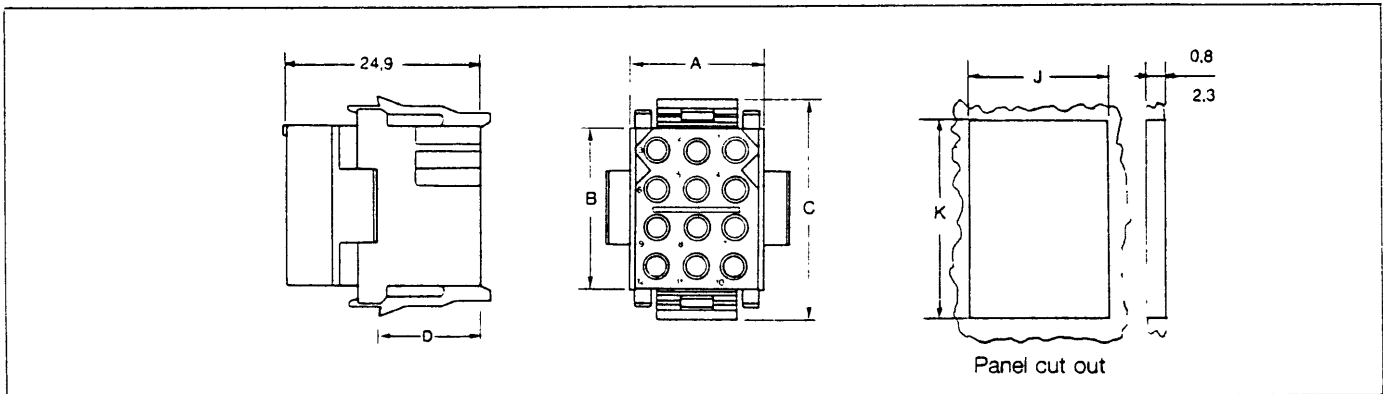

N° of positions	Catalogue number	Dimensions				Panel cut-out Dimensions mm ± 0,13 mm	
		A	B	C max.	D	J	K
2	SMS 2 R 1	10,9	5,8	15,2	13,2	11,4	11,6
3	SMS 3 R 1*	16,0	5,8	15,2	13,2	16,5	11,6
4	SMS 4 R 1	21,1	5,8	15,2	13,2	21,7	11,6
6	SMS 6 R 1*	16,0	10,9	20,3	13,2	16,5	16,7
9	SMS 9 R 1	16,0	16,0	25,4	13,2	16,5	21,6
12	SMS 12 R 1*	16,0	21,1	30,5	13,2	16,7	26,7
15	SMS 15 R 1	16,0	26,2	35,6	13,2	16,7	31,8
18	SMS 18 R 1	16,0	31,2	40,6	13,2	16,7	36,9
24	SMS 24 R 1*	21,1	31,2	40,6	13,2	21,7	36,9
36	SMS 36 R 1*	46,5	21,1	30,5	13,2	47,2	26,7

* Standard item

Accessories for standard Qikmate Connectors

Strain relief hood

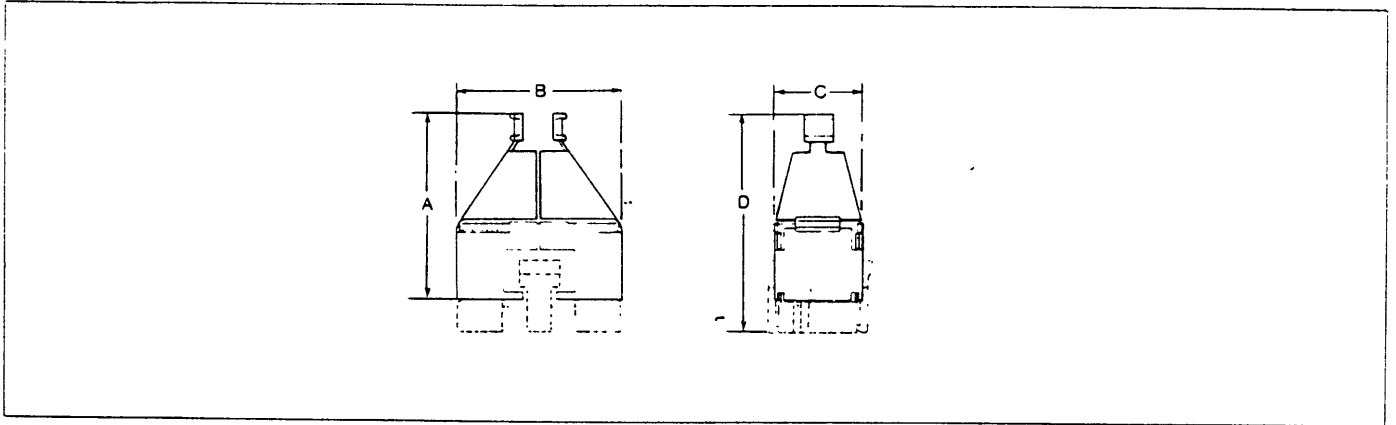

Qikmate contact positions	Catalogue number	Wire bundle \varnothing max mm	Recommended Unirap cable tie	Dimensions			
				A	B	C	D (max.)
2	SMS 2 H 1	8,4	TF-4	46,2	16,7	10,6	56,3
3	SMS 3 H 1*	8,4	TF-4	46,2	19,3	10,6	56,3
4	SMS 4 H 1	9,9	TF-4	46,2	24,3	10,6	56,3
6	SMS 6 H 1*	8,1	TF-4	46,2	19,3	15,7	56,3
9	SMS 9 H 1	9,1	TF-5	45,2	19,3	20,8	55,3
12	SMS 12 H 1*	10,2	TF-5	45,2	19,3	25,9	55,3
15	SMS 15 H 1	10,9	TF-5	50,2	19,3	30,9	60,4
18	SMS 18 H 1	11,7	TF-5	50,2	19,3	36,0	60,4
24	SMS 24 H 1*	12,7	TF-5	50,5	24,3	36,0	60,7
36	SMS 36 H 1*	15,7	TF-5	57,9	49,7	25,9	68,0

* Standard item

Pin Protection shroud

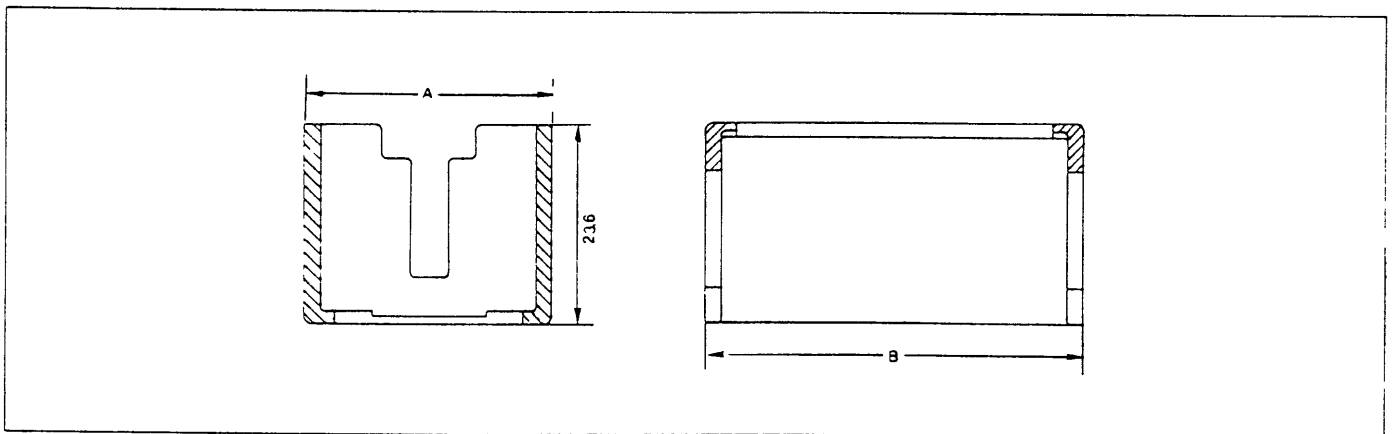

N° of contacts	Catalogue number	Dimensions in mm	
		A	B
2	SMS 2 CSB1	19,8	18,8
3	SMS 3 CSB1	23,4	18,8
4	SMS 4 CSB1	28,4	18,8
6	SMS 6 CSB1	23,4	23,9
9	SMS 9 CSB1	23,4	29,0
12	SMS 12 CSB1	23,4	34,0
15	SMS 15 CSB1	23,4	39,1
18	SMS 18 CSB1	23,4	44,2
24	SMS 24 CSB1	28,4	44,2
36	SMS 36 CSB1	54,1	34,0

P.C. Board Receptacles

Straight version

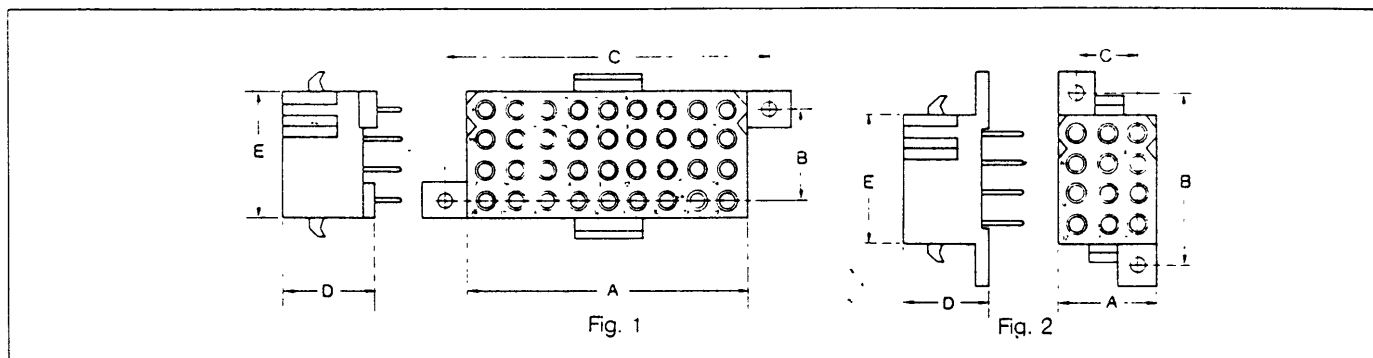

Version with solid machined contacts

N° of positions	Catalogue number		Fig.	Dimensions				
	with socket contacts	with pin contacts		A	B	C	D	E
2	SMS 2GE3	SMS 2GE4	1	10,9	-	19,1	13,2	5,8
3	SMS 3GE3*	SMS 3GE4*	2	16,0	14,0	10,2	13,2	5,8
4	SMS 4GE3	SMS 4GE4	2	21,1	14,0	15,2	13,2	5,8
6	SMS 6GE3*	SMS 6GE4*	2	16,0	19,0	10,2	13,2	10,9
12	SMS 12GE3*	SMS 12GE4*	2	16,0	29,2	10,2	13,2	21,1
18		SMS 18GE4	1	16,0	39,4	10,2	13,2	31,2
24	SMS 24GE3*	SMS 24GE4*	2	21,1	39,4	15,2	13,2	31,2
36	SMS 36GE3*	SMS 36GE4*	1	46,5	15,2	54,6	13,2	21,2

* Standard item

Version with stamped and formed contacts

N° of positions	Catalogue number		Dimensions				
	with socket contacts	with pin contacts	A	B	C	D	E
2	SMS 2RE3 TK6	SMS 2RE4 TK6	10,9	-	19,1	13,2	5,8
3	SMS 3RE3 TK6	SMS 3RE4 TK6	16,0	14,0	10,2	13,2	5,8
4	SMS 4RE3 TK6	SMS 4RE4 TK6	21,1	14,0	15,2	13,2	5,8
6	SMS 6RE3 TK6	SMS 6RE4 TK6	16,0	19,0	10,2	13,2	10,9
12	SMS 12RE3 TK6	SMS 12RE4 TK6	16,0	29,2	10,2	13,2	21,1
18		SMS 18RE4 TK6	16,0	39,4	10,2	13,2	31,2
24	SMS 24RE3 TK6	SMS 24RE4 TK6	21,1	39,4	15,2	13,2	31,2
36	SMS 36RE3 TK6	SMS 36RE4 TK6	46,5	15,2	54,6	13,2	21,2

Right angle version

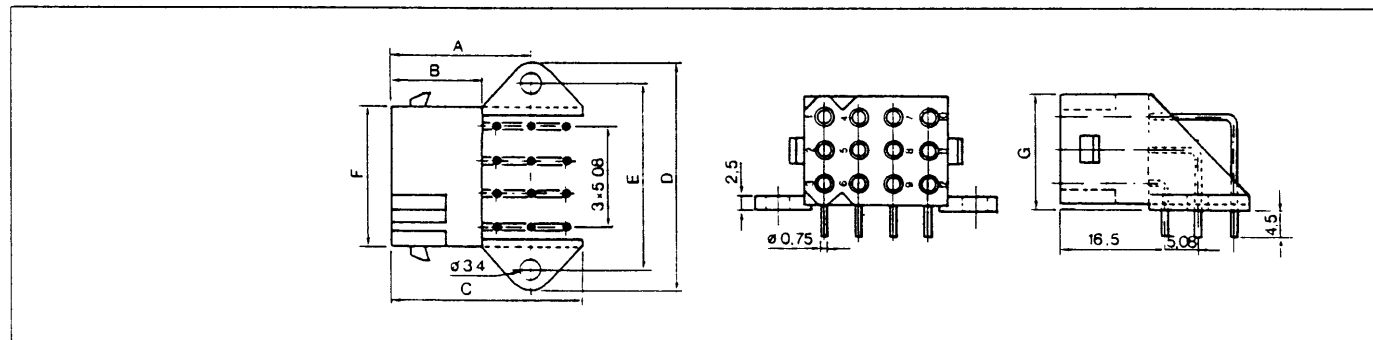

Version with solid machined contacts

N° of positions	Catalogue number		Dimensions						
	with socket contacts	with pin contacts	A	B	C	D	E	F	G
3	SMS 3GE5*	SMS 3GE6*	16,5	14,5	20,5	30,2	24,2	16,2	6,8
6	SMS 6GE5*	SMS 6GE6*	19,0	14,5	24,5	30,2	24,2	16,2	11,7
12	SMS 12GE5*	SMS 12GE6*	21,6	14,5	29,5	35,2	29,2	21,2	17,2

* Standard item

P.C. Pin Headers

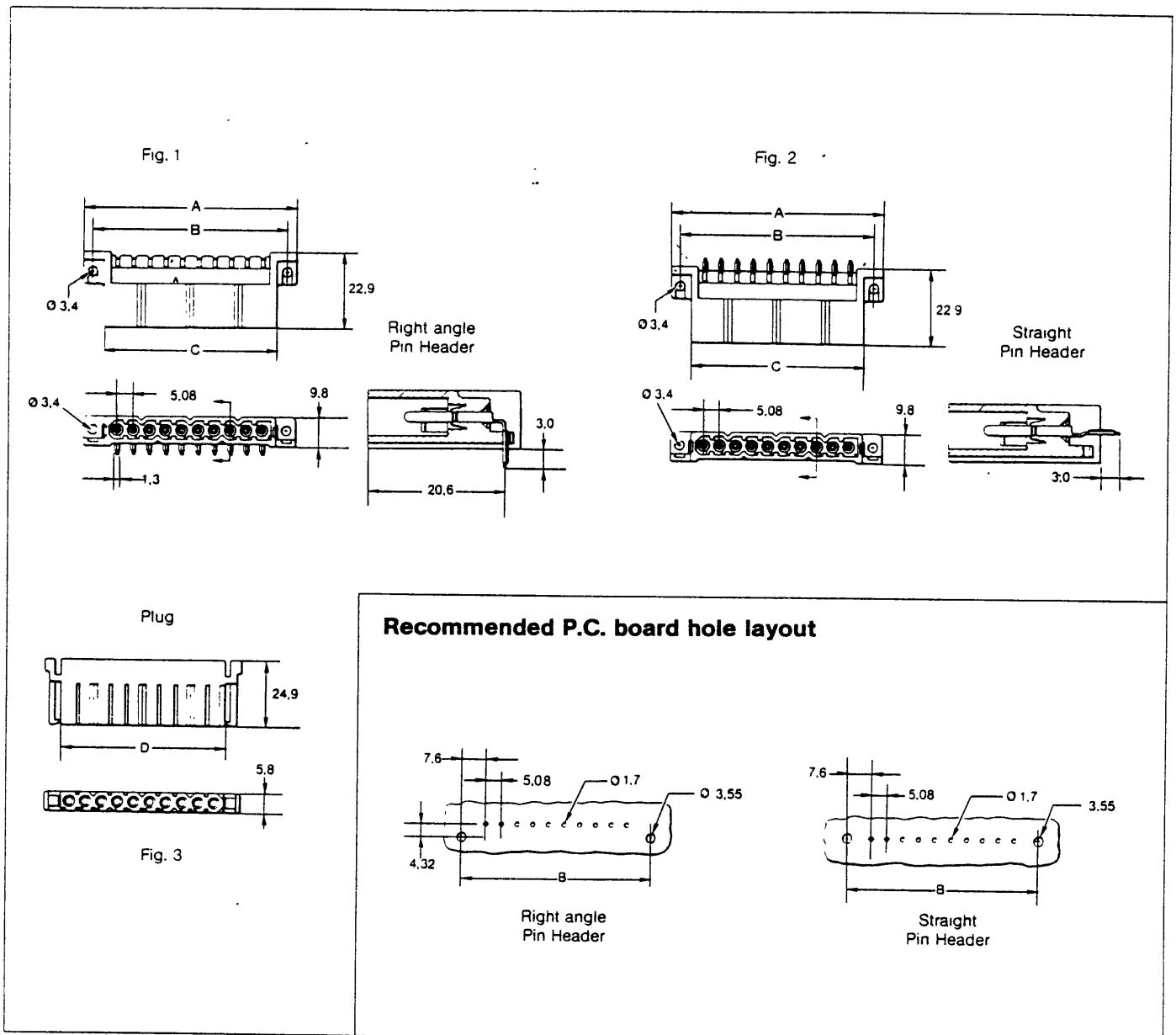

Version with solid machined contacts

N° of positions	Catalogue number			Dimensions in mm			
	Socket plug fig. 3	Board Mount Header		A	B	C	D
		Right Angle version Fig. 1	Straight version Fig. 2				
3	SMS 3P 3	SMS 3PH GE6	SMS 3PH GE4	31,2	25,4	19,3	16,0
4	SMS 4P 3	SMS 4PH GE6	SMS 4PH GE4	36,3	30,4	24,4	21,1
6	SMS 6P 3	SMS 6PH GE6	SMS 6PH GE4	46,5	40,6	34,5	31,2
9	SMS 9P 3	SMS 9PH GE6	SMS 9PH GE4	61,7	55,9	49,8	46,5
10	SMS 10P 3	SMS 10PH GE6	SMS 10PH GE4	66,8	61,0	54,9	51,6

Version with stamped and formed contacts

N° of positions	Catalogue number			Dimensions in mm			
	Socket plug fig. 3	Board Mount Header		A	B	C	D
		Right Angle version Fig. 1	Straight version Fig. 2				
3	SMS 3P 3	SMS 3PH 3TK6	SMS 3PH 4TK6	31,2	25,4	19,3	16,0
4	SMS 4P 3	SMS 4PH 3TK6	SMS 4PH 4TK6	36,3	30,4	24,4	21,1
6	SMS 6P 3	SMS 6PH 3TK6	SMS 6PH 4TK6	46,5	40,6	34,5	31,2
9	SMS 9P 3	SMS 9PH 3TK6	SMS 9PH 4TK6	61,7	55,9	49,8	46,5
10	SMS 10P 3	SMS 10PH 3TK6	SMS 10PH 4TK6	66,8	61,0	54,9	51,6

Accessories

Discrimination pins

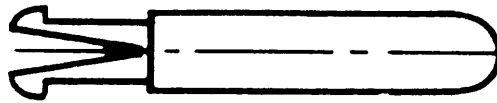

These take the form of a plastic «contact» which can be inserted into an unfilled contact hole. When the discriminating pin is fitted, the Trim-Trio connector assembly will only mate with an assembly which has a vacant contact hole at the corresponding contact position. When ordering, please quote catalogue number: SMSPKEO.

Applications

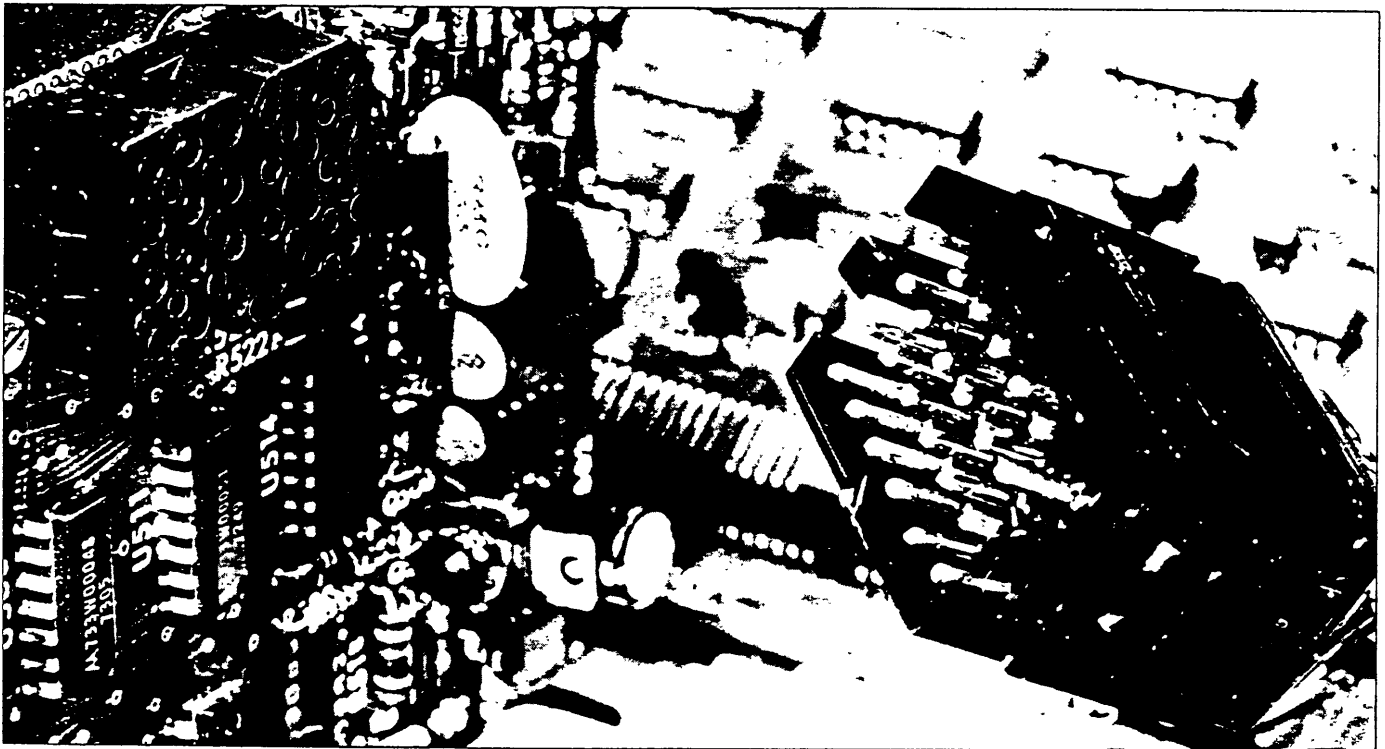

The list of QIKMATE applications is endless — from radio and TV to domestic appliances. Many users have already found that the qualities of QIKMATE connectors are ideal — wherever there is a need for reliability at a reasonable price.

Sales and Manufacturing facilities in:

Baar/CH, Mechelen,	Stockholm, Waddinxveen,
Torino, Paris,	Barcelona, Norwalk/Ct.,
Steinenbronn/Stgt.,	Toronto, Tokyo,
St. Albans/Herts,	São Paulo, Mexico City,
	Hong Kong, Sydney

Burndy reserves the right to alter specifications of the equipment described in this brochure without prior notice.

Copyright © 1987 Burndy Corporation. All rights reserved.