

### Major Ratings and Characteristics

Characteristics	175BGQ045	Units
$I_{F(AV)}$ Rectangular waveform @ $T_C$	175 107	A °C
$I_{DC}$ Maximum	248	A
$V_{RRM}$	45	V
$I_{FSM}$ @ $t_p = 5 \mu s$ sine	8700	A
$V_F$ @ 175Apk typical @ $T_J$	0.61 150	V °C
$T_J$ range	-55 to 150	°C

### Description/Features

The NEW 175BGQ045 Schottky rectifier has been optimized for ultra low forward voltage drop specifically for low voltage output in high current AC/DC power supplies.

The proprietary barrier technology allows for reliable operation up to 150°C junction temperature. Typical applications are in switching power supplies, converters, reverse battery protection, and redundant power subsystems.

- 150°C  $T_J$  operation
- High Frequency Operation
- Ultra low forward voltage drop
- Continuous High Current operation
- Guard ring for enhanced ruggedness and long term reliability
- **PowIRtab™ package**

### Case Styles

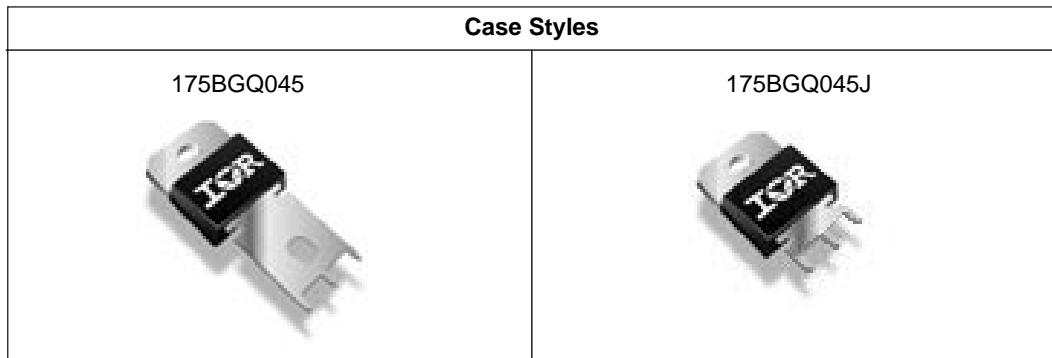

175BGQ045, 175BGQ045J

PD-20710 rev. C 11/99

Voltage Ratings

Part number	175BGQ045
V <sub>R</sub> Max. DC Reverse Voltage (V)	45
V <sub>RWM</sub> Max. Working Peak Reverse Voltage (V)	

Absolute Maximum Ratings

Parameters	175BGQ	Units	Conditions
I <sub>F(AV)</sub> Max. Average Forward Current	175	A	50% duty cycle @ T <sub>C</sub> = 107°C, rectangular wave form
I <sub>F(RMS)</sub> RMS Forward Current	248	A	T <sub>C</sub> = 104°C
I <sub>FSM</sub> Max. Peak One Cycle Non-Repetitive Surge Current	8700	A	5µs Sine or 3µs Rect. pulse
	1550		10ms Sine or 6ms Rect. pulse
E <sub>AS</sub> Non-Repetitive Avalanche Energy	40	mJ	T <sub>J</sub> = 25°C, I <sub>AS</sub> = 6 Amps, L = 2.0 mH
I <sub>AR</sub> Repetitive Avalanche Current	6	A	Current decaying linearly to zero in 1 µsec Frequency limited by T <sub>J</sub> max. V <sub>A</sub> = 1.5 x V <sub>R</sub> typical

Electrical Specifications

Parameters	175BGQ		Units	Conditions	
	Typ.	Max.			
V <sub>FM</sub> Forward Voltage Drop (1) (2)	0.53	0.56	V	@ 100A	T <sub>J</sub> = 25°C
	0.64	0.69	V	@ 175A	
	0.48	0.52	V	@ 100A	T <sub>J</sub> = 150°C
	0.61	0.64	V	@ 175A	
I <sub>RM</sub> Reverse Leakage Current (1)	0.6	2	mA	T <sub>J</sub> = 25°C	V <sub>R</sub> = rated V <sub>R</sub>
	360	640	mA	T <sub>J</sub> = 125°C	
	1200	2000	mA	T <sub>J</sub> = 150°C	V <sub>R</sub> = 45V
V <sub>F(TO)</sub> Threshold Voltage	0.352		V	T <sub>J</sub> = T <sub>J</sub> max.	
r <sub>t</sub> Forward Slope Resistance	1.5		mΩ		
C <sub>T</sub> Max. Junction Capacitance	5600		pF	V <sub>R</sub> = 5V <sub>DC</sub> , (test signal range 100Khz to 1Mhz) 25°C	
L <sub>S</sub> Typical Series Inductance	3.5		nH	Measured from tab to mounting plane	
dv/dt Max. Voltage Rate of Change (Rated V <sub>R</sub> )	10,000		V/µs		

(1) Pulse Width < 300µs, Duty Cycle < 2%

(2) V<sub>FM</sub> = V<sub>F(TO)</sub> + r<sub>t</sub> x I<sub>F</sub>

Thermal-Mechanical Specifications

Parameters	175BGQ	Units	Conditions
T <sub>J</sub> Max. Junction Temperature Range	-55 to 150	°C	
T <sub>stg</sub> Max. Storage Temperature Range	-55 to 150	°C	
R <sub>thJC</sub> Max. Thermal Resistance Junction to Case	0.25	°C/W	DC operation
R <sub>thCS</sub> Typical Thermal Resistance, Case to Heatsink	0.20	°C/W	Mounting surface, smooth and greased
wt Approximate Weight	5(0.18)	g(oz.)	
T Mounting Torque	Min.	1.2(10)	N*m (lbf-in)
	Max.	2.4(20)	
Case Style	PowIRtab™		

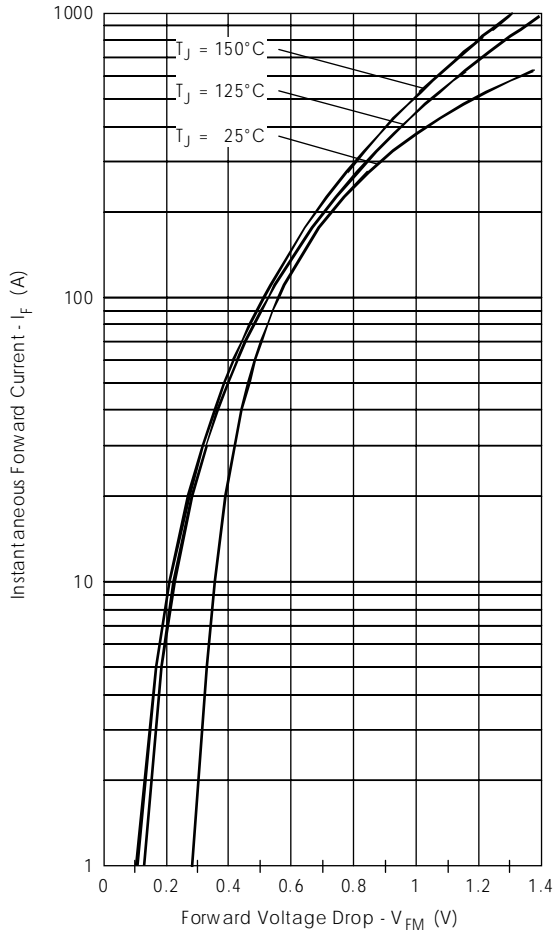

Fig. 1 - Maximum Forward Voltage Drop Characteristics

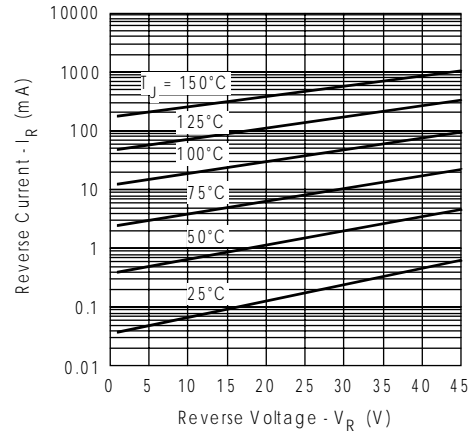

Fig. 2 - Typical Values of Reverse Current Vs. Reverse Voltage

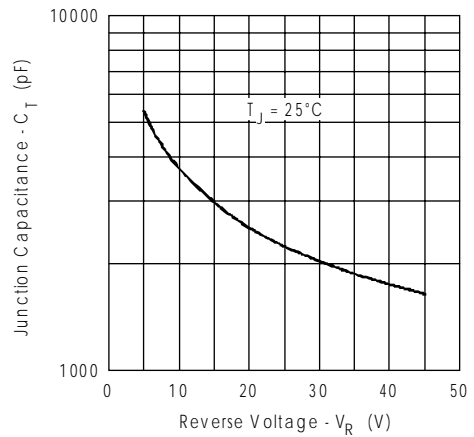

Fig. 3 - Typical Junction Capacitance Vs. Reverse Voltage

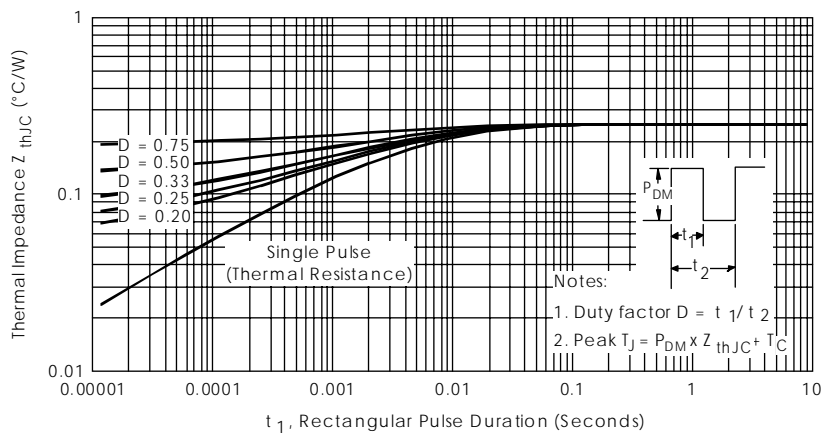

Fig. 4 - Maximum Thermal Impedance  $Z_{thJC}$  Characteristics

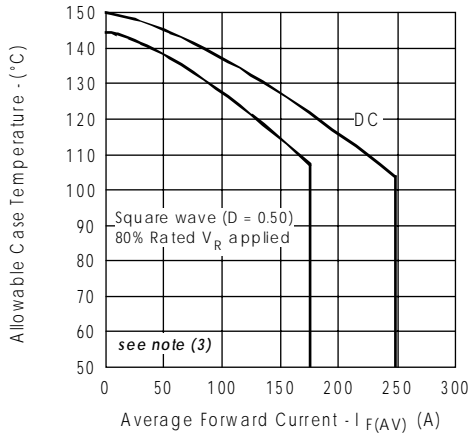

Fig.5- Maximum Allowable Case Temperature Vs. Average Forward Current

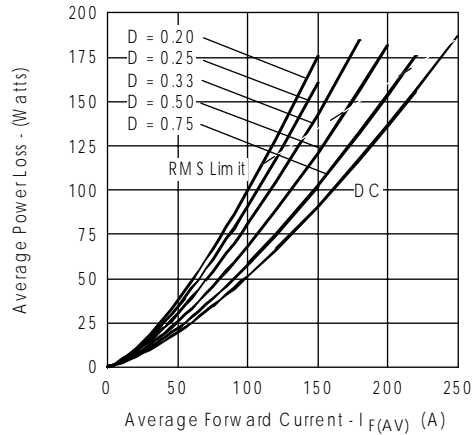

Fig.6- Forward Power Loss Characteristics

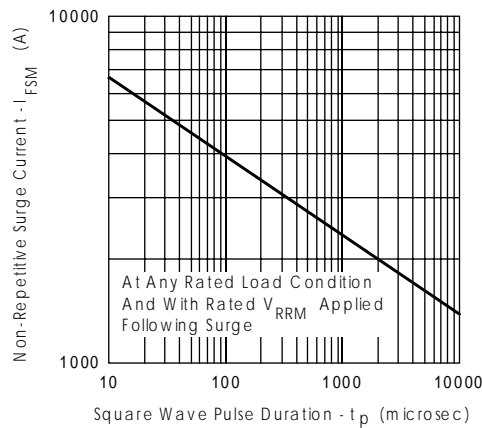

Fig.7- Maximum Non-Repetitive Surge Current

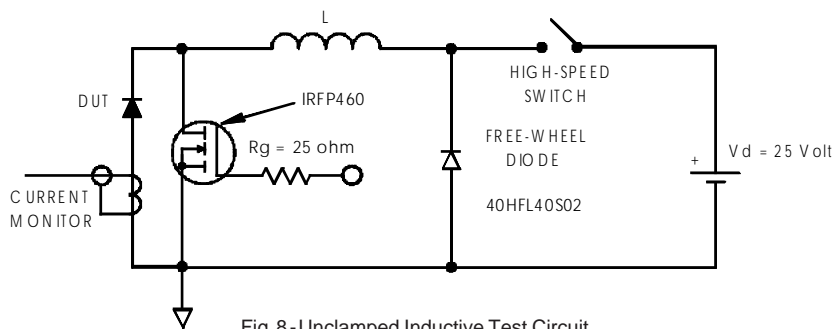

Fig.8- Unclamped Inductive Test Circuit

(3) Formula used:  $T_c = T_j - (P_d + P_{d_{REV}}) \times R_{thJC}$ ;

$P_d$  = Forward Power Loss =  $I_{F(AV)} \times V_{FM} @ (I_{F(AV)} / D)$  (see Fig. 6);

$P_{d_{REV}}$  = Inverse Power Loss =  $V_{R1} \times I_R (1 - D)$ ;  $I_R @ V_{R1} = 80\%$  rated  $V_R$

Ordering Information Table

**Device Code**

175	BGQ	045	J
①	②	③	④

- 1** - Current Rating
- 2** - Essential Part Number
- 3** - Voltage code: Code =  $V_{RRM}$
- 4** - none = PowIRtab™ standard  
 J = Short Lead Version

Outline Table

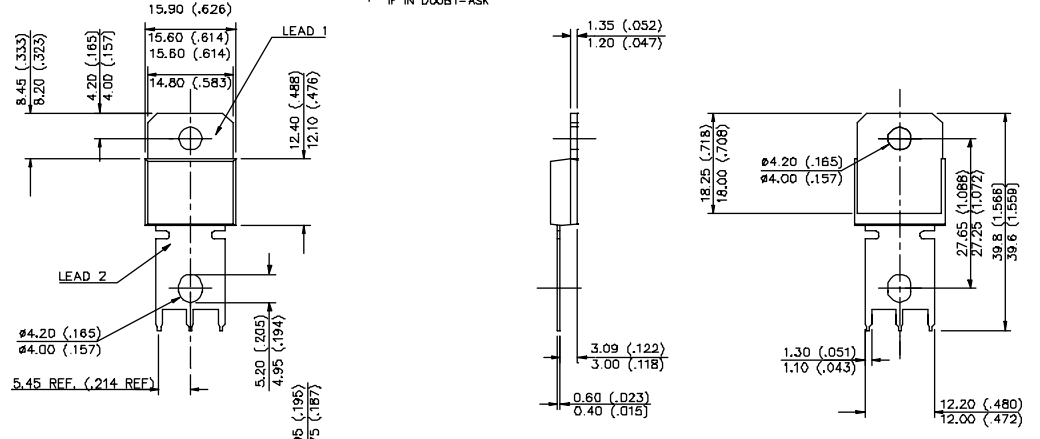

 THIRD ANGLE PROJECTION  
 IF IN DOUBT-ASK



**LEAD ASSIGNMENTS**    **NOTES**  
 LEAD 1 = CATHODE            DIMENSIONS IN MILLIMETRES (INCHES)  
 LEAD 2 = ANODE

**Case Style PowIRtab™**  
 Dimensions in millimeters and (inches)

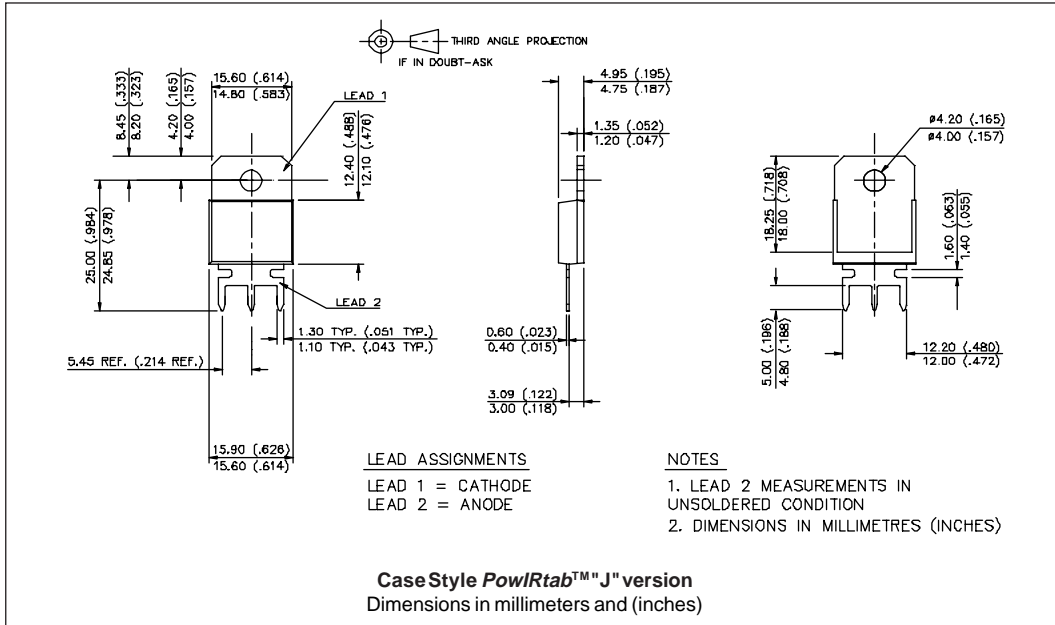
Outline Table



```

*****
This model has been developed by
Wizard SPICE MODEL GENERATOR(1999)
(International Rectifier Corporation)
contains Proprietary Information

*****

SPICE Model Diode is composed by a
simple diode plus paralld VCG2T
*****

.SUBCKT 175bgq45 ANO CAT
D1 ANO 1 DMOD (0.24359)
*Define diode model
.MODEL DMOD D(IS=1.83192228095708E-04A,N=1.05013272757567,BV=45V,
+IBV=0.318718355472911A,RS=0.0003020516,CJO=5.36650017916966E-08,
+VJ=0.773797902206145,XTI=2,EG=0.707245556720411)
*****
*Implementation of VCG2T
VX 1 2 DC 0V
R1 2 CAT TRES 1E-6
.MODEL TRES RES(R=1,TC1=5.6216088199529)
GP1 ANO CAT VALUE={-ABS(I(VX))*(EXP(((((-2.339145E-03/
5.621609)*(V(2,CAT)*1E6)/(I(VX)+1E-6)-1))+1)*5.687601E-02*ABS(V(ANO,CAT))))-1)}

*****

.ENDS 175bgq45

Thermal Model Subcircuit
.SUBCKT 175bgq45T 5 1

CTHERM1 5 4 1.71E+3
CTHERM2 4 3 3.63E+2
CTHERM3 3 2 3.23E+4
CTHERM4 2 1 3.12E+5

RTHERM1 5 4 3.24E-2
RTHERM2 4 3 1.52E-1
RTHERM3 3 2 4.08E-2
RTHERM4 2 1 1.81E-4

.ENDS 175bgq45T

```

**WORLD HEADQUARTERS:** 233 Kansas St., El Segundo, California 90245 U.S.A. Tel: (310) 322 3331. Fax: (310) 322 3332.

**EUROPEAN HEADQUARTERS:** Hurst Green, Oxted, Surrey RH8 9BB, U.K. Tel: ++ 44 1883 732020. Fax: ++ 44 1883 733408.

**IR CANADA:** 15 Lincoln Court, Brampton, Markham, Ontario L6T3Z2. Tel: (905) 453 2200. Fax: (905) 475 8801.

**IR GERMANY:** Saalburgstrasse 157, 61350 Bad Homburg. Tel: ++ 49 6172 96590. Fax: ++ 49 6172 965933.

**IR ITALY:** Via Liguria 49, 10071 Borgaro, Torino. Tel: ++ 39 11 4510111. Fax: ++ 39 11 4510220.

**IR FAR EAST:** K&H Bldg., 2F, 30-4 Nishi-Ikebukuro 3-Chome, Toshima-Ku, Tokyo, Japan 171. Tel: 81 3 3983 0086.

**IR SOUTHEAST ASIA:** 1 Kim Seng Promenade, Great World City West Tower, 13-11, Singapore 237994. Tel: ++ 65 838 4630.

**IR TAIWAN:** 16 Fl. Suite D.207, Sec. 2, Tun Haw South Road, Taipei, 10673, Taiwan. Tel: 886 2 2377 9936.

<http://www.irf.com>

Fax-On-Demand: +44 1883 733420

Data and specifications subject to change without notice.