

HP - 5FR2

The HP - 5FR2 is a high - output, high - speed silicon photodiode mounted in a sidelooking plastic package with daylight filter. The HP - 5FR3 and HP - 5FR4 photodiode with a different daylight filter(IR - 88 type), are available in the same package.

FEATURES

- High - output power for IRED
- High - speed response
- Wide angular response
- Relatively low - cost against metal can package
- Sidelooking plastic package with daylight filter

APPLICATIONS

- Remote control sensors
- Optical switches
- Photocouplers

DIMENSIONS

(Unit : mm)

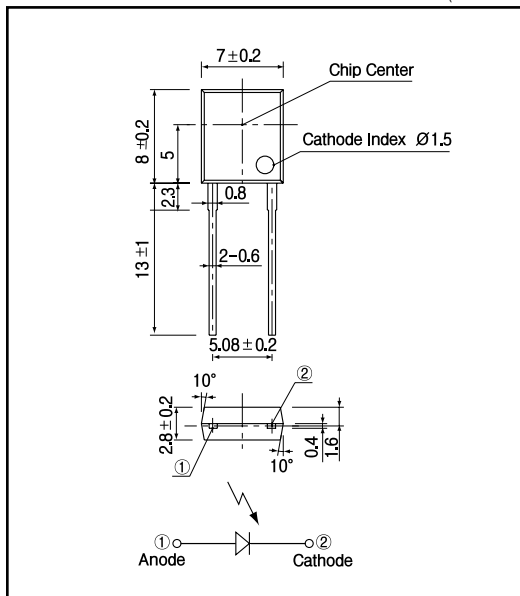

MAXIMUM RATINGS

(Ta=25)

Item	Symbol	Rating	Unit
Reverse voltage	V _r	35	V
Power dissipation	P _b	150	mW
Operating temp.	T _{opr.}	- 30 ~ + 70	
Storage temp.	T _{stg.}	- 40 ~ + 80	
Soldering temp. *1	T _{sol.}	260	

*1. For MAX.5 seconds at the position of 2 mm from the package

ELECTRO-OPTICAL CHARACTERISTICS

(Ta=25)

Item	Symbol	Conditions	Min.	Typ.	Max.	Unit.
Open circuit voltage	V _{oc}	E _v = 1,000lx *2		0.38		V
Short circuit current	I _{sc}		40	60		μA
Dark current	I _d	V _r = 10V			30	nA
Curve factor	C.F.		0.55			-
Capacitance	C _t	V = 0V, f = 1MHz		175		pF
Temperature coefficient of V _{oc}	t			- 2.2		mV/
Temperature coefficient of I _{sc}	t			0.18		%/
Spectral sensitivity				700 ~ 1,050		nm
Peak wavelength	p			940		nm
Half angle				± 70		deg.

*2. Color temp. = 2856K standard Tungsten lamp

Photo diodes

HP - 5FR2

Light current Vs. Forward voltage

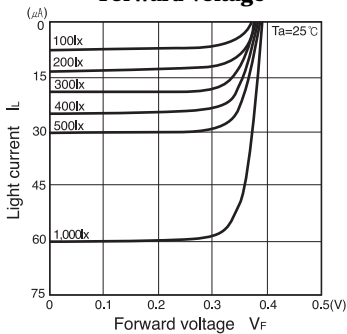

Short circuit current Vs. Illuminance

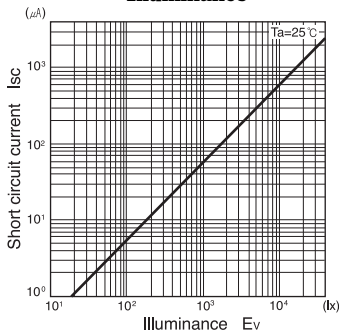

Dark current Vs. Ambient temperature

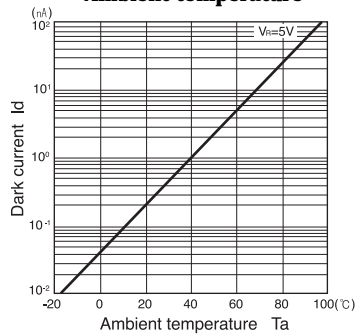

Relative sensitivity Vs. Wavelength

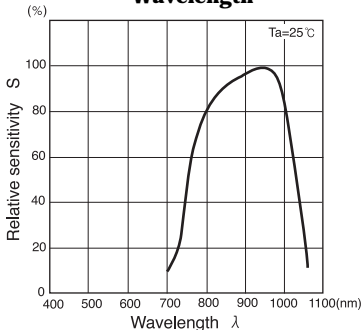

Dark current Vs. Reverse voltage

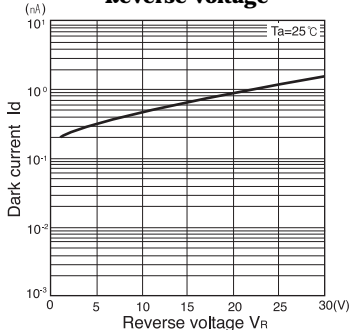

Radiant Pattern

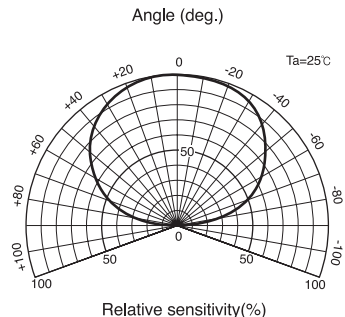

Capacitance between terminals Vs. Reverse voltage

