

SMPS MOSFET

IRFB42N20D

HEXFET® Power MOSFET

Applications

- High frequency DC-DC converters
- Motor Control
- Uninterruptible Power Supplies

V_{DSS}	R_{DS(on)} max	I_D
200V	0.055Ω	44A

Benefits

- Low Gate-to-Drain Charge to Reduce Switching Losses
- Fully Characterized Capacitance Including Effective C_{OSS} to Simplify Design, (See App. Note AN1001)
- Fully Characterized Avalanche Voltage and Current

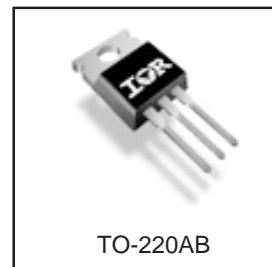

Absolute Maximum Ratings

	Parameter	Max.	Units
I _D @ T _C = 25°C	Continuous Drain Current, V _{GS} @ 10V	44	A
I _D @ T _C = 100°C	Continuous Drain Current, V _{GS} @ 10V	31	
I _{DM}	Pulsed Drain Current ①	180	
P _D @ T _A = 25°C	Power Dissipation	2.4	W
P _D @ T _C = 25°C	Power Dissipation	330	
	Linear Derating Factor	2.2	W/°C
V _{GS}	Gate-to-Source Voltage	± 30	V
dv/dt	Peak Diode Recovery dv/dt ③	2.5	V/ns
T _J	Operating Junction and	-55 to + 175	°C
T _{STG}	Storage Temperature Range		
	Soldering Temperature, for 10 seconds	300 (1.6mm from case)	
	Mounting torque, 6-32 or M3 screw	10 lbf•in (1.1N•m)	

Thermal Resistance

	Parameter	Typ.	Max.	Units
R _{θJC}	Junction-to-Case	—	0.45	°C/W
R _{θCS}	Case-to-Sink, Flat, Greased Surface	0.50	—	
R _{θJA}	Junction-to-Ambient	—	62	

Notes ① through ⑤ are on page 8

Static @ T_J = 25°C (unless otherwise specified)

	Parameter	Min.	Typ.	Max.	Units	Conditions
V _{(BR)DSS}	Drain-to-Source Breakdown Voltage	200	—	—	V	V _{GS} = 0V, I _D = 250μA
ΔV _{(BR)DSS} /ΔT _J	Breakdown Voltage Temp. Coefficient	—	0.26	—	V/°C	Reference to 25°C, I _D = 1mA
R _{DS(on)}	Static Drain-to-Source On-Resistance	—	—	0.055	Ω	V _{GS} = 10V, I _D = 26A ④
V _{GS(th)}	Gate Threshold Voltage	3.0	—	5.5	V	V _{DS} = V _{GS} , I _D = 250μA
I _{DSS}	Drain-to-Source Leakage Current	—	—	25	μA	V _{DS} = 200V, V _{GS} = 0V
		—	—	250		V _{DS} = 160V, V _{GS} = 0V, T _J = 150°C
I _{GSS}	Gate-to-Source Forward Leakage	—	—	100	nA	V _{GS} = 30V
	Gate-to-Source Reverse Leakage	—	—	-100		V _{GS} = -30V

Dynamic @ T_J = 25°C (unless otherwise specified)

	Parameter	Min.	Typ.	Max.	Units	Conditions
g _{fs}	Forward Transconductance	21	—	—	S	V _{DS} = 50V, I _D = 26A
Q _g	Total Gate Charge	—	91	140	nC	I _D = 26A
Q _{gs}	Gate-to-Source Charge	—	24	36		V _{DS} = 160V
Q _{gd}	Gate-to-Drain ("Miller") Charge	—	43	65		V _{GS} = 10V,
t _{d(on)}	Turn-On Delay Time	—	18	—		V _{DD} = 100V
t _r	Rise Time	—	69	—	ns	I _D = 26A
t _{d(off)}	Turn-Off Delay Time	—	29	—		R _G = 1.8Ω
t _f	Fall Time	—	32	—		V _{GS} = 10V ④
C _{iss}	Input Capacitance	—	3430	—	pF	V _{GS} = 0V
C _{oss}	Output Capacitance	—	530	—		V _{DS} = 25V
C _{rss}	Reverse Transfer Capacitance	—	100	—		f = 1.0MHz
C _{oss}	Output Capacitance	—	5310	—		V _{GS} = 0V, V _{DS} = 1.0V, f = 1.0MHz
C _{oss}	Output Capacitance	—	210	—		V _{GS} = 0V, V _{DS} = 160V, f = 1.0MHz
C _{oss eff.}	Effective Output Capacitance	—	400	—		V _{GS} = 0V, V _{DS} = 0V to 160V ⑤

Avalanche Characteristics

	Parameter	Typ.	Max.	Units
E _{AS}	Single Pulse Avalanche Energy②	—	510	mJ
I _{AR}	Avalanche Current①	—	26	A
E _{AR}	Repetitive Avalanche Energy①	—	33	mJ

Diode Characteristics

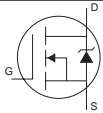
	Parameter	Min.	Typ.	Max.	Units	Conditions
I _S	Continuous Source Current (Body Diode)	—	—	44	A	MOSFET symbol showing the integral reverse p-n junction diode. 
I _{SM}	Pulsed Source Current (Body Diode) ①	—	—	180		
V _{SD}	Diode Forward Voltage	—	—	1.3	V	T _J = 25°C, I _S = 26A, V _{GS} = 0V ④
t _{rr}	Reverse Recovery Time	—	220	330	ns	T _J = 25°C, I _F = 26A
Q _{rr}	Reverse Recovery Charge	—	1860	2790	nC	di/dt = 100A/μs ④
t _{on}	Forward Turn-On Time	Intrinsic turn-on time is negligible (turn-on is dominated by L _S +L _D)				

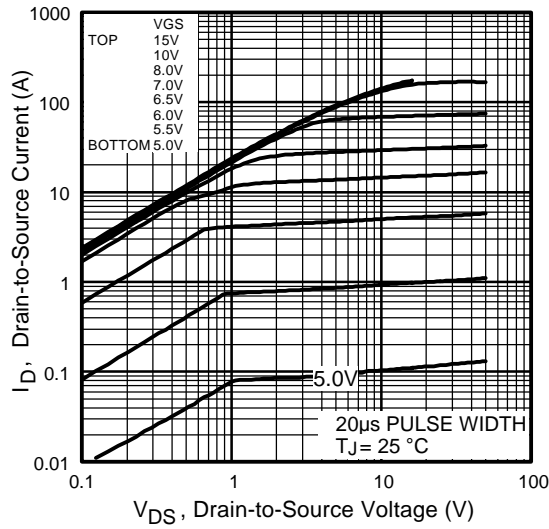

Fig 1. Typical Output Characteristics

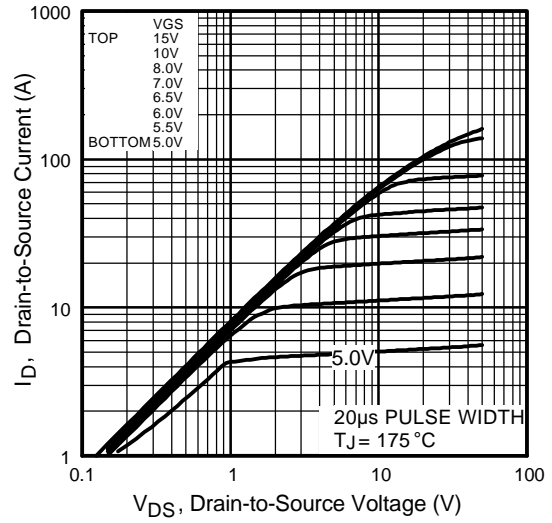

Fig 2. Typical Output Characteristics

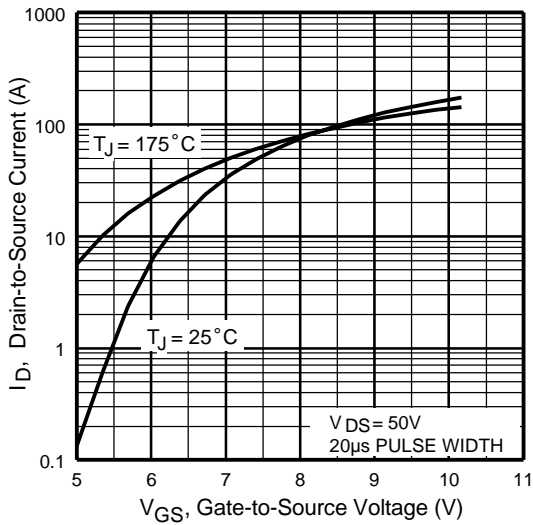

Fig 3. Typical Transfer Characteristics

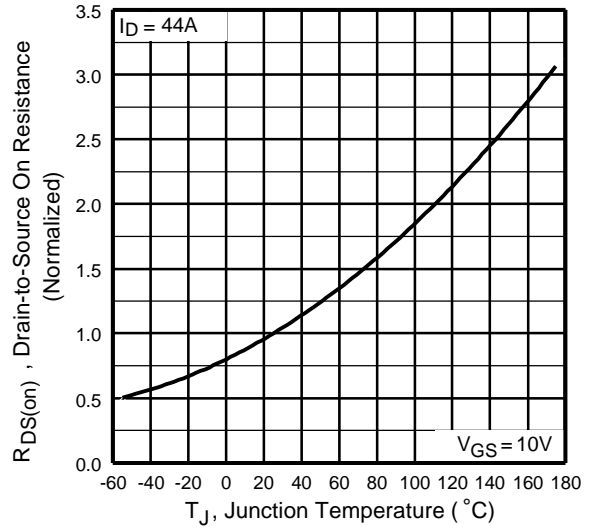

Fig 4. Normalized On-Resistance Vs. Temperature

IRFB42N20D

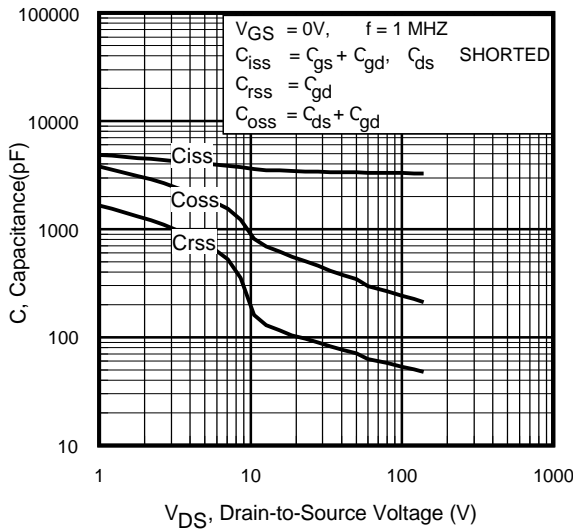

Fig 5. Typical Capacitance Vs. Drain-to-Source Voltage

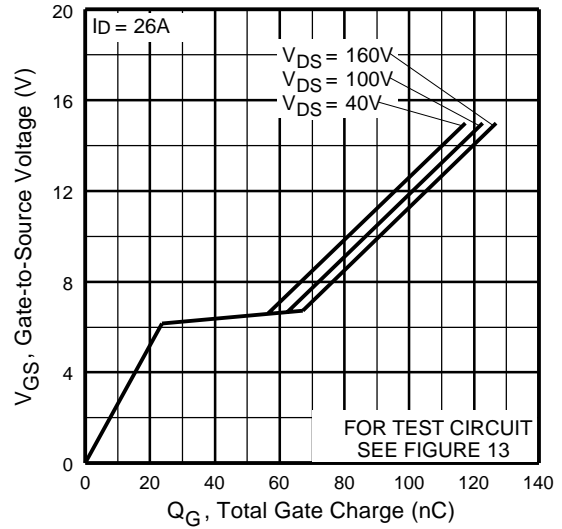

Fig 6. Typical Gate Charge Vs. Gate-to-Source Voltage

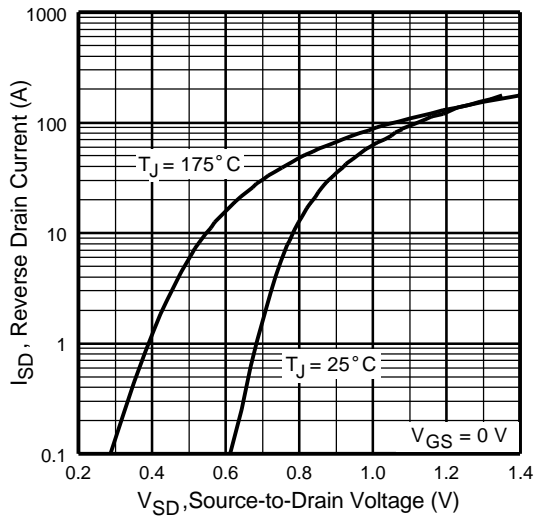

Fig 7. Typical Source-Drain Diode Forward Voltage

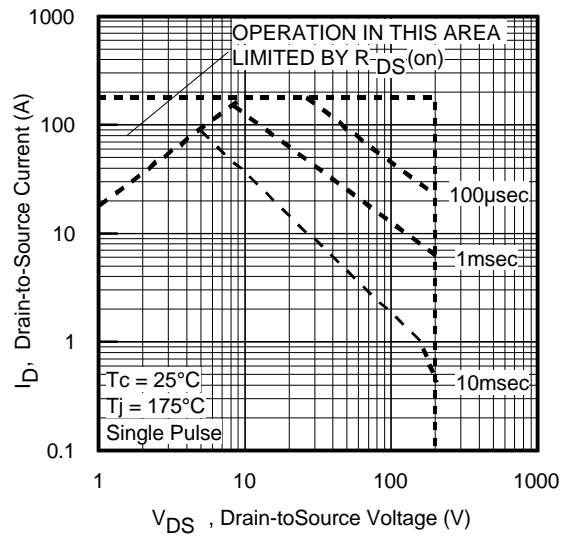

Fig 8. Maximum Safe Operating Area

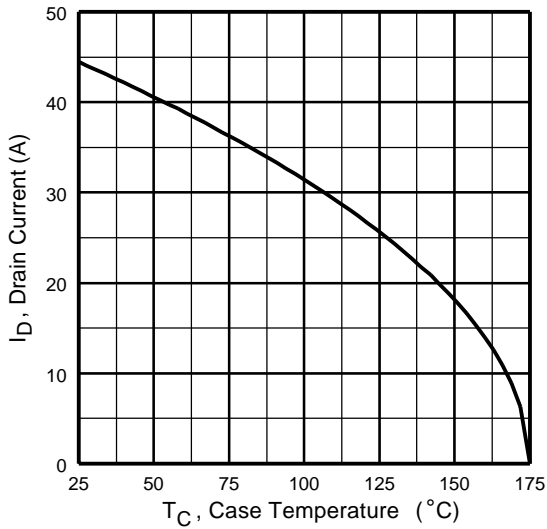

Fig 9. Maximum Drain Current Vs. Case Temperature



Fig 10a. Switching Time Test Circuit



Fig 10b. Switching Time Waveforms

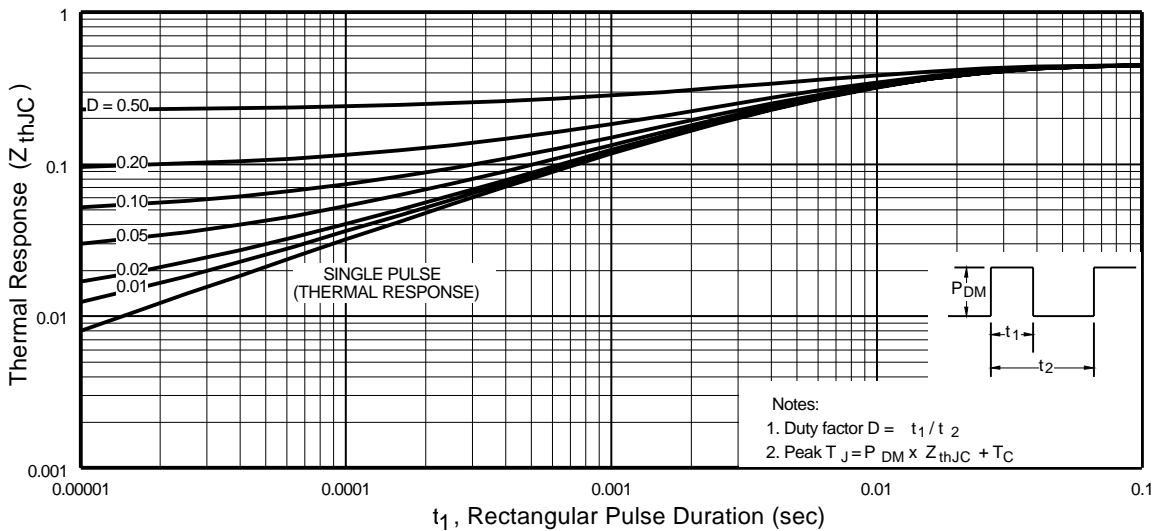

Fig 11. Maximum Effective Transient Thermal Impedance, Junction-to-Case

IRFB42N20D

International
IR Rectifier

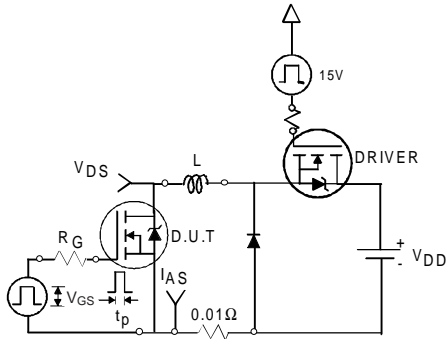

Fig 12a. Unclamped Inductive Test Circuit



Fig 12b. Unclamped Inductive Waveforms

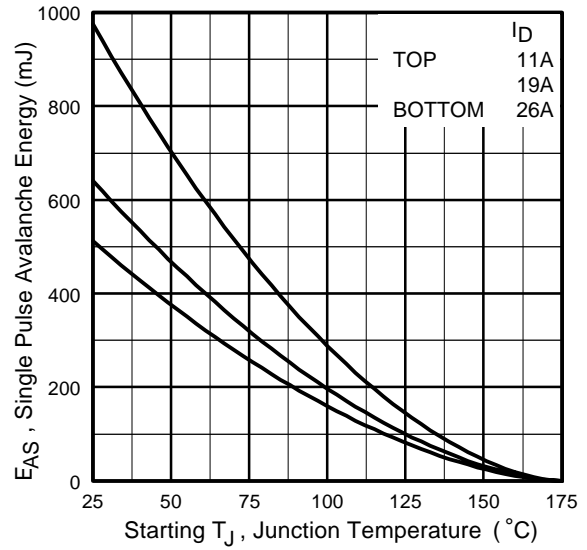

Fig 12c. Maximum Avalanche Energy Vs. Drain Current

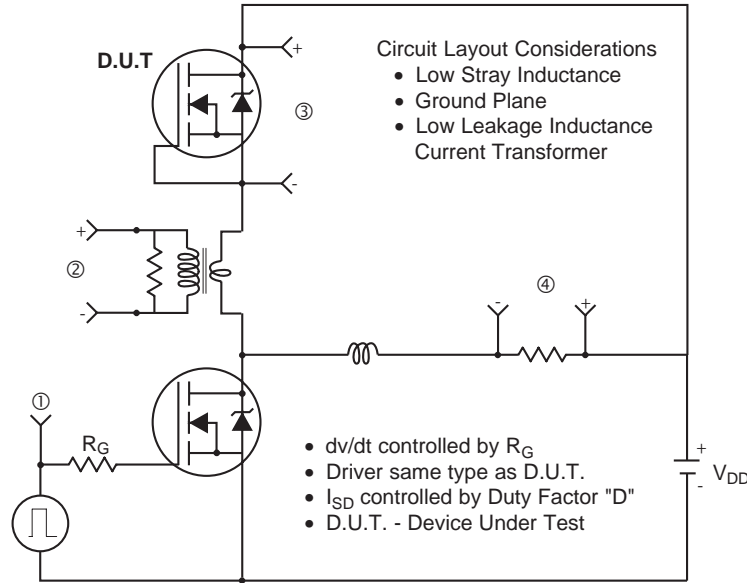

Fig 13a. Basic Gate Charge Waveform



Fig 13b. Gate Charge Test Circuit

Peak Diode Recovery dv/dt Test Circuit



* $V_{GS} = 5V$ for Logic Level Devices

Fig 14. For N-Channel HEXFET® Power MOSFETs

IRFB42N20D

International
IR Rectifier

TO-220AB Package Outline

Dimensions are shown in millimeters (inches)

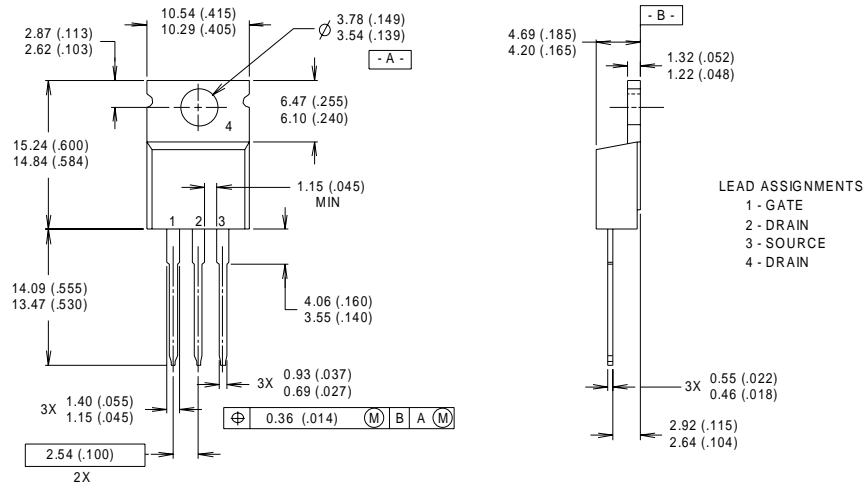

NOTES:

1 DIMENSIONING & TOLERANCING PER ANSI Y14.5M, 1982.
2 CONTROLLING DIMENSION : INCH

3 OUTLINE CONFORMS TO JEDEC OUTLINE TO-220AB.
4 HEATSINK & LEAD MEASUREMENTS DO NOT INCLUDE BURRS.

TO-220AB Part Marking Information

EXAMPLE: THIS IS AN IRF1010
LOT CODE 1789
ASSEMBLED ON VWV 19, 1997
IN THE ASSEMBLY LINE "C"

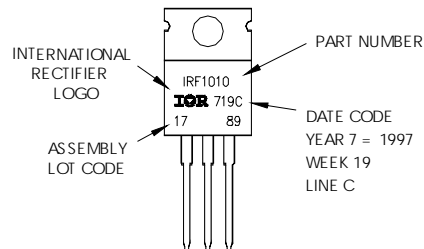

Notes:

- ① Repetitive rating; pulse width limited by max. junction temperature.
- ② Starting $T_J = 25^\circ\text{C}$, $L = 1.45\text{mH}$
 $R_G = 25\Omega$, $I_{AS} = 26\text{A}$, $V_{GS} = 10\text{V}$
- ③ $I_{SD} \leq 26\text{A}$, $di/dt \leq 110\text{A}/\mu\text{s}$, $V_{DD} \leq V_{(BR)DSS}$,
 $T_J \leq 175^\circ\text{C}$
- ④ Pulse width $\leq 400\mu\text{s}$; duty cycle $\leq 2\%$.
- ⑤ C_{OSS} eff. is a fixed capacitance that gives the same charging time as C_{OSS} while V_{DS} is rising from 0 to 80% V_{DSS}

Data and specifications subject to change without notice.
This product has been designed and qualified for the Industrial market.
Qualification Standards can be found on IR's Web site.

International
IR Rectifier

IR WORLD HEADQUARTERS: 233 Kansas St., El Segundo, California 90245, USA Tel: (310) 252-7105
TAC Fax: (310) 252-7903

Visit us at www.irf.com for sales contact information.5/01
www.irf.com