



14 W BTL AUDIO POWER AMPLIFIER

MB3730A

September 1988
Edition 1.0

14 W BTL AUDIO POWER AMPLIFIER

The Fujitsu MB3730A is designed for a low-frequency high-power amplifier with internal BTL (Balanced Transformer Less) circuitry. The MB3730A is packed in 7 pin single in line plastic package and requires a few external components, this enables high density mounting. Design for heat radiation is easy because thermal resistance is low 3°C/W.

The MB3730A contains internal power-on pop noise protection circuit and various protection circuits. The device is suitable best for car-stereo.

- High power output : 14W typ.
- Minimum external components
- Various protection circuits
 - Over voltage protection
 - Load short protection
 - Thermal protection
 - Output pin-to-DC short protection
- No break-down: between pins is shorted or inverted insertion
- Low thermal resistance : 3°C/W
- On-chip power-on pop noise protection circuit
- 7-pin Plastic Single In Line package (Suffix: -PS)

ABSOLUTE MAXIMUM RATINGS (see NOTE) (T_C=25°C)

Rating	Symbol	Value	Unit
Power Supply Voltage	V _{CC}	18	V
Power Supply Voltage (Surge)	V _{CCS}	50 *	V
Output Current (Peak)	I _{OPEAK}	4.5	A
Power Dissipation	P _D	18	W
Operating Temperature (Case)	T _C	-20 to +75	°C
Storage Temperature	T _{STG}	-55 to +150	°C

Note: * t_s ≤ 0.2 sec, t_r ≥ 1 msec

Permanent device damage may occur if the above Absolute Maximum Ratings are exceeded. Functional operation should be restricted to the conditions as detailed in the operational sections of this data sheet. Exposure to absolute maximum rating conditions for extended periods may affect device reliability.

3

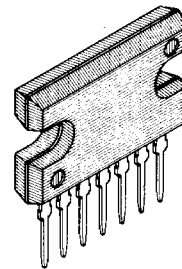

PLASTIC PACKAGE
SIP-07P-M01

PIN ASSIGNMENT

(FRONT VIEW)

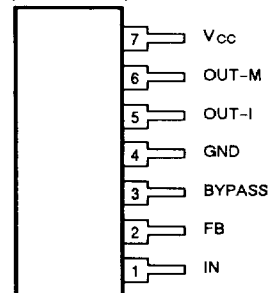

This device contains circuitry to protect the inputs against damage due to high static voltages or electric fields. However, it is advised that normal precautions be taken to avoid application of any voltage higher than maximum rated voltages to this high impedance circuit.

Fig. 1 - MB3730A BLOCK DIAGRAM

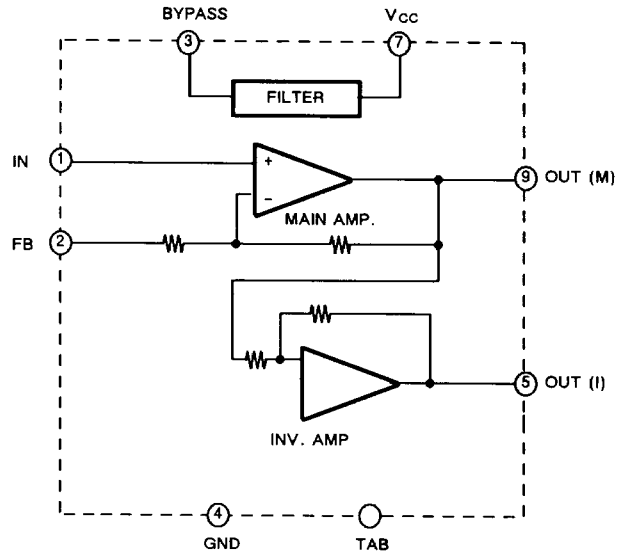

RECOMMENDED OPERATING CONDITIONS

Parameter	Symbol	Value	Unit
Power Supply Voltage	V _{cc}	8 to 16	V
Operating Temperature(Case)	T _c	-20 to +75	°C

ELECTRICAL CHARACTERISTICS (T_c = 25°C, V_{cc} = 13.2V, R_L = 4Ω, f = 1kHz)

Parameter	Symbol	Condition	Values			Unit
			Min	Typ	Max	
Quiescent Power Supply Current	I _Q	V _{in} =0V, R _L = ∞		80	200	mA
Voltage Gain	A _V	P _O = 1W	52.5	55	57.5	dB
Output Power	P _O	THD=10%	10	14		W
Total Harmonic Distortion	THD	P _O =1W		0.2	1.0	%
Output Noise Voltage	V _{NO}	R _G =10kΩ, BW=20 Hz to 20kHz		1.0	2.0	mV
Input Resistance	R _{IN}		40	70		kΩ
Output Offset Voltage	V _{OO}	V _{IN} = 0V		0.2	0.4	V

3

Fig. 2 - TYPICAL CONNECTION EXAMPLE

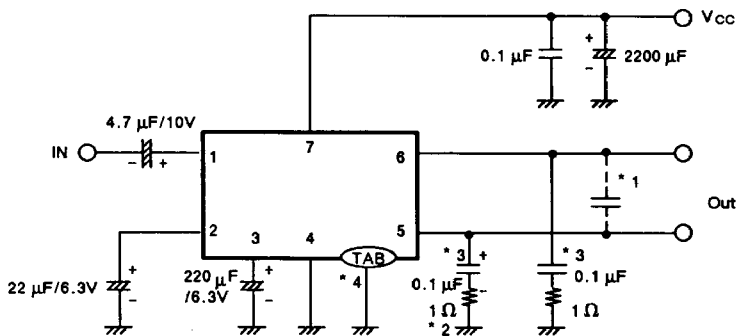

- Notes:
- *1 Effective to prevent from oscillation depending on printing pattern.
 - *2 When power supply line is stable, please connect with V_{cc} side, it restrains the oscillation.
 - *3 Use Mylar Capacitor.
 - *4 The TAB should be connected with GND.

Fig. 3 - RECOMMENDED CONNECTION PATTERN (BOTTOM VIEW)

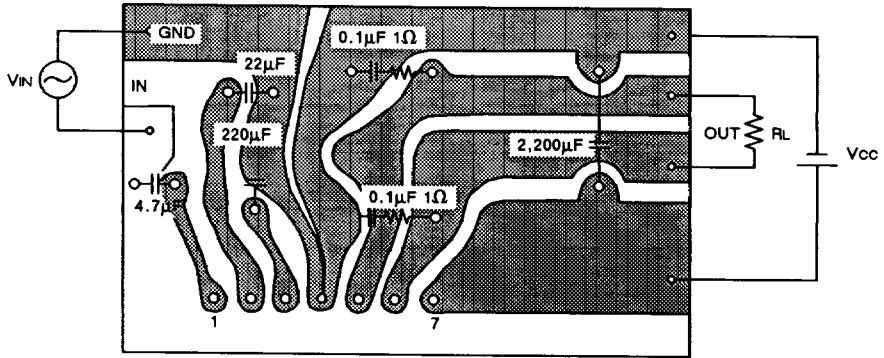

TYPICAL CHARACTERISTICS CURVES

Fig. 4 - TOTAL HARMONIC DISTORTION vs. OUTPUT POWER

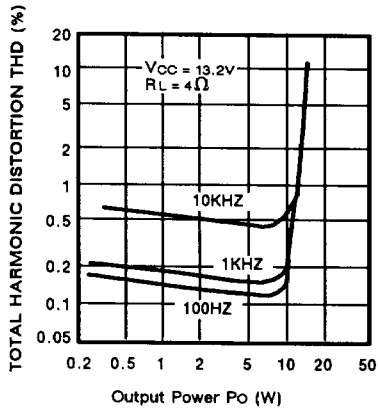
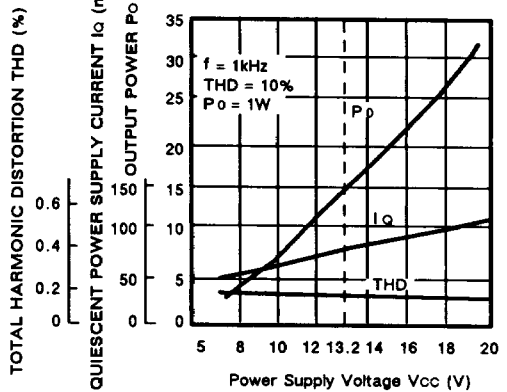

Fig. 5 - OUTPUT POWER/TOTAL HARMONIC DISTORTION/QUIESCENT POWER SUPPLY CURRENT vs. POWER SUPPLY VOLTAGE



TYPICAL CHARACTERISTICS CURVES (Continued)

Fig. 6 - VOLTAGE GAIN vs. FREQUENCY

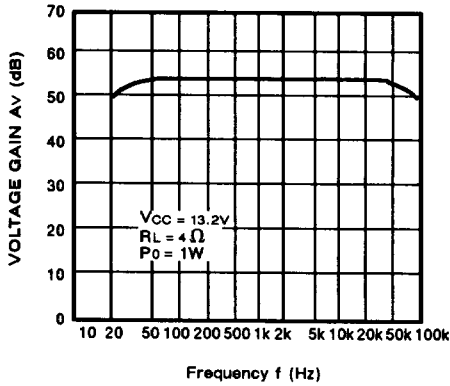

Fig. 7 - TOTAL HARMONIC DISTORTION vs. FREQUENCY

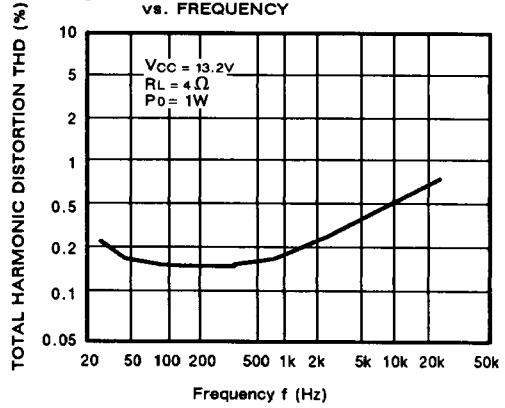
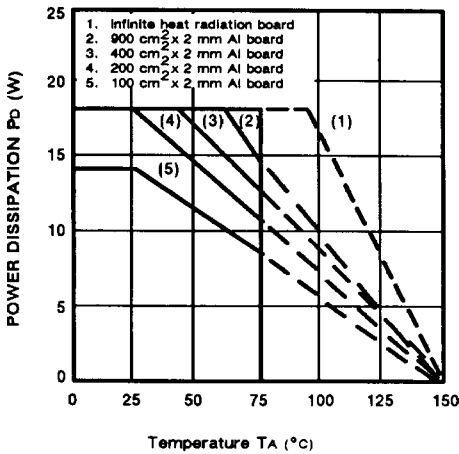

Fig. 8 - POWER DISSIPATION vs. TEMPERATURE





FUJITSU

MB3730A

PACKAGE DIMENSION

3

