

μ A78HGA Positive Adjustable 5-Amp Voltage Regulator

Hybrid Products

Description

The μ A78HGA is an adjustable 4-terminal positive voltage regulator capable of supplying in excess of 5.0 A over a 5.0 V to 24 V output range. Only two external resistors are required to set the output voltage.

The μ A78HGA is packaged in a hermetically sealed TO-3, providing 50 W power dissipation. The regulator consists of a monolithic chip driving a discrete series-pass element. A beryllium-oxide substrate is used in conjunction with an isothermal layout to optimize the thermal characteristics of each device and still maintain electrical isolation between the various chips. This unique circuit design limits the maximum junction temperature of the power output transistor to provide full automatic thermal overload protection. If the safe operating area is ever exceeded (Note 1), the device simply shuts down rather than failing or damaging other system components. This feature eliminates the need to design costly regulators built from discrete components.

- 5.0 A OUTPUT CURRENT
- INTERNAL CURRENT AND THERMAL LIMITING
- INTERNAL SHORT CIRCUIT CURRENT LIMIT
- LOW DROPOUT VOLTAGE (TYPICALLY 2.3 V @ 5.0 A)
- 50 W POWER DISSIPATION
- ELECTRICALLY NEUTRAL CASE
- STEEL TO-3 PACKAGE
- ALL PIN-FOR-PIN COMPATIBLE WITH μ A78HG

Connection Diagram TO-3 Metal Package

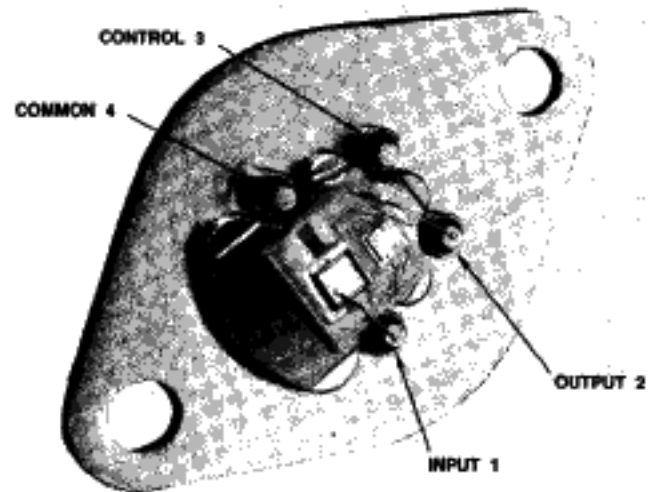

(Top View)

Order Information

Type	Package	Code	Part No.
μ A78HGA	Metal	JA	μ A78HGASC
μ A78HGA	Metal	JA	μ A78HGASM

Block Diagram—Positive Adjustable Voltage Regulator

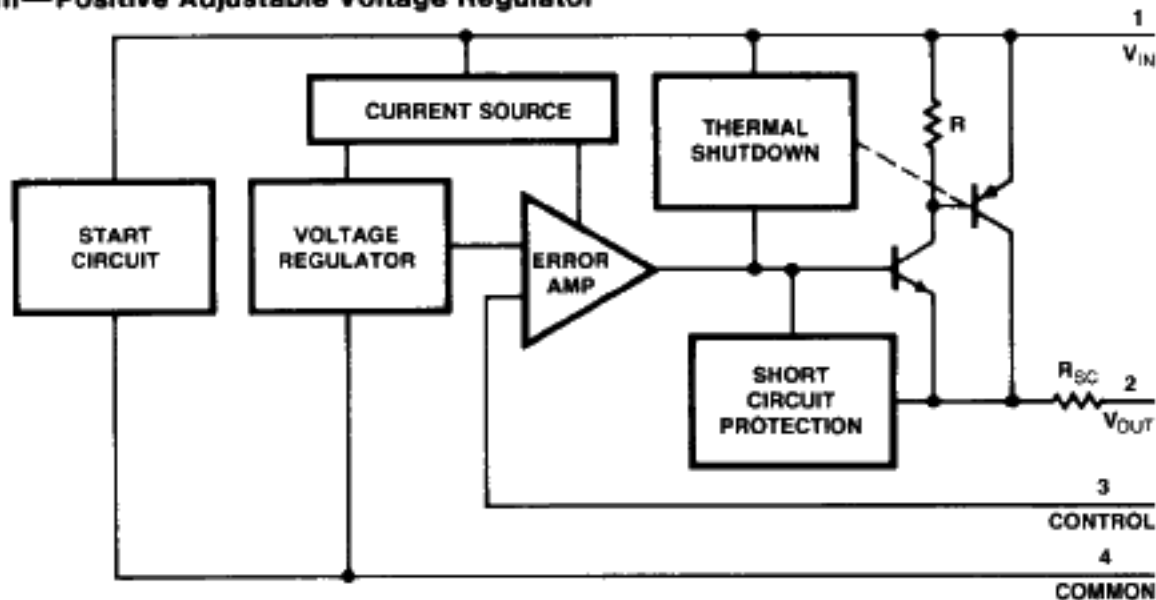

Notes on following pages.

Absolute Maximum Ratings

Input Voltage	40 V	Commercial Temperature Range	0°C to +150°C
Internal Power Dissipation	50 W @ 25°C Case	Storage Temperature Range	-55°C to +150°C
Maximum Input-to-Output Voltage		Pin Temperature (Soldering, 60 s)	300°C
Differential Output Short Circuit	35 V		
Operating Junction Temperature	150°C		
Military Temperature Range μA78HGASM	-55°C to +150°C		

Electrical Characteristics $T_J = 25^\circ\text{C}$, $V_{IN} = 10\text{ V}$, $I_{OUT} = 2.0\text{ A}$ unless otherwise specified

Symbol	Characteristic	Condition (Note 3)	Limits			Unit
			Min	Typ	Max	
V_{OUT}	Output Voltage (Note 4)	$I_{OUT} = 2.0\text{ A}$, $V_{IN} = V_{OUT} + 3.5\text{ V}$	5.0		24	V
ΔV_{OUT}	Line Regulation (Note 2)	$V_{IN} = 7.5\text{ to }25\text{ V}$		0.2%	1%	V
ΔV_{OUT}	Load Regulation (Note 2)	$10\text{ mA} \leq I_{OUT} \leq 5.0\text{ A}$		0.2%	1%	V
I_Q	Quiescent Current	$I_{OUT} = 0$		3.4	10	mA
RR	Ripple Rejection	$I_{OUT} = 1.0\text{ A}$, $f = 210\text{ Hz}$, 5.0 V_{pk-pk}	60			dB
V_n	Output Noise	$10\text{ Hz} \leq f \leq 100\text{ kHz}$, $V_{IN} = V_{OUT} + 5.0\text{ V}$		50		μVRMS
V_{DD}	Dropout Voltage (Note 5)	$I_{OUT} = 5.0\text{ A}$		2.3	2.5	V
		$I_{OUT} = 3.0\text{ A}$		2.0	2.3	V
I_{OS}	Short-Circuit Current Limit	$V_{IN} = 15\text{ V}$		7.0	12.0	A_{pk}
V_C	Control Pin Voltage		4.85	5.0	5.25	V

Notes

- This voltage regulator offers output transistor safe-area protection. However, to maintain full protection, the device must be operated within the maximum input-to-output voltage differential rating listed on the data sheet under "Absolute Maximum Ratings." For applications violating these limits, device will not be fully protected.
- Load and line regulation are specified at constant junction temperature. Pulse testing is required with a pulse width $\leq 1\text{ ms}$ and a duty cycle $\leq 5\%$. Full Kelvin connection methods must be used to measure these parameters.
- The performance characteristics of the adjustable series (μA78HGA) is specified for $V_{OUT} = 5.0\text{ V}$, unless otherwise noted.
- V_{OUT} is defined as $V_{OUT} = \frac{R1 + R2}{R2} (V_{CONT})$ where $R1$ and $R2$ are defined in the Basic Test Circuit diagram.
- Dropout Voltage is the input-output voltage differential that causes the output voltage to decrease by 5% of its initial value.

Typical Performance Curves

Output Impedance

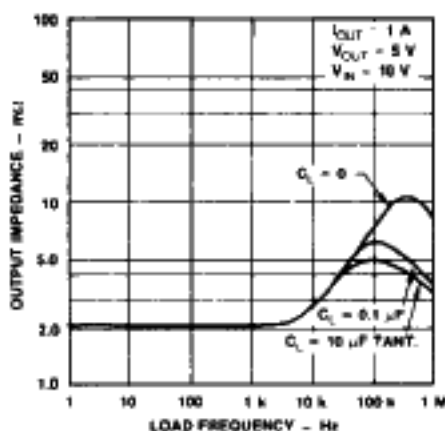

Output Noise Voltage

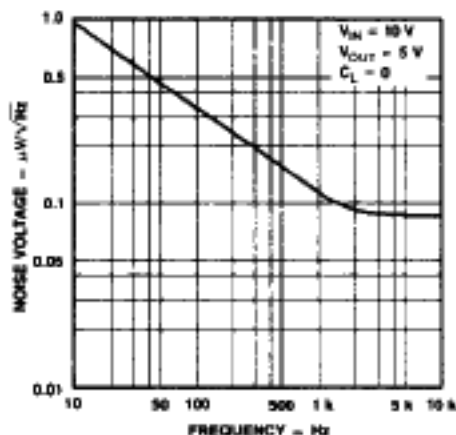

Maximum Power Dissipation

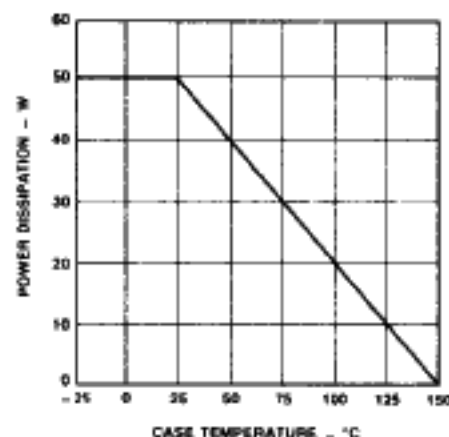

Typical Performance Curves (Cont.)

Short Circuit Current

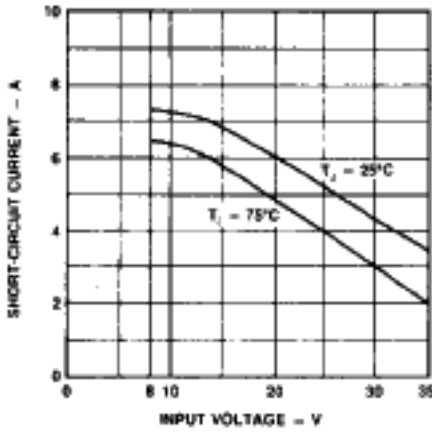

Quiescent Current

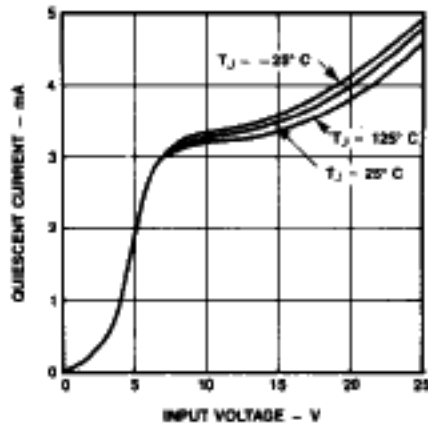

Dropout Voltage

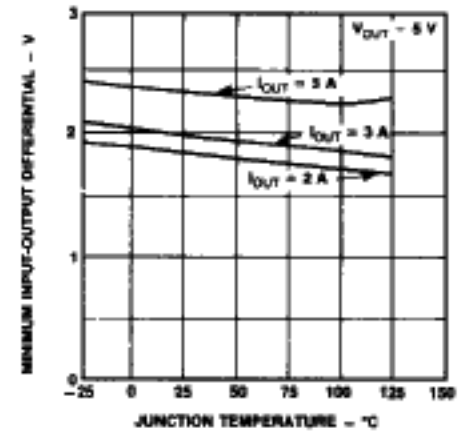

Line Regulation

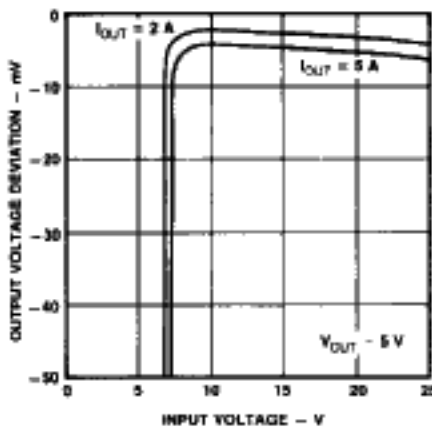

Line Transient Response

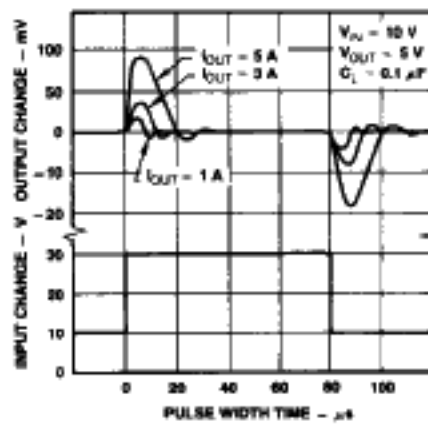

Ripple Rejection

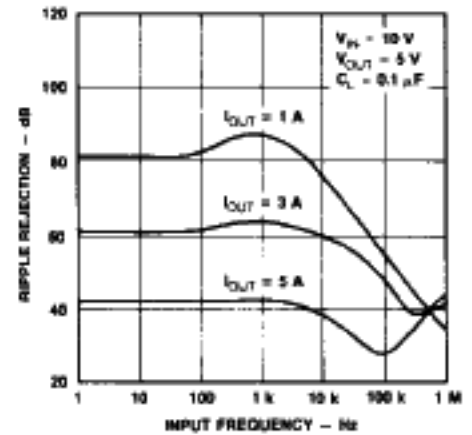

Load Regulation

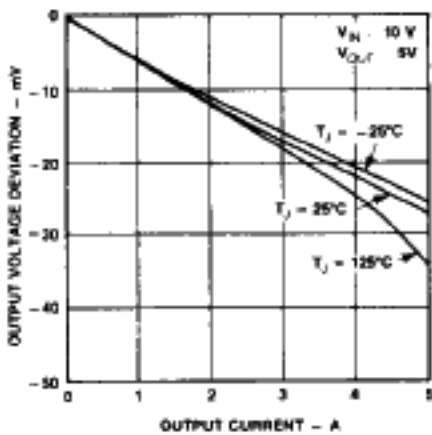

Load Transient Response

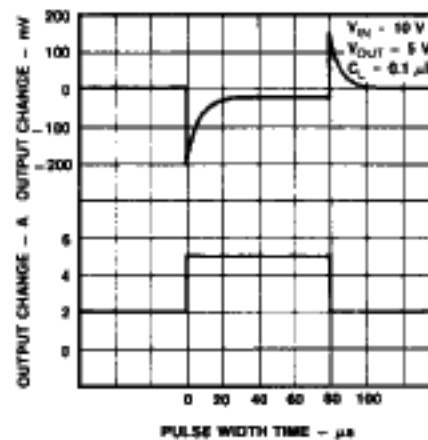

Output Voltage Deviation vs Junction Temperature

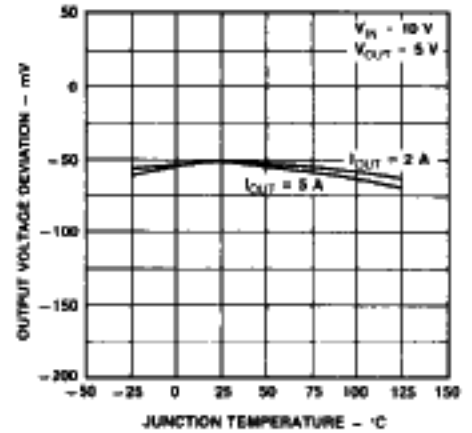

Test Circuit

Adjustable Output Voltage

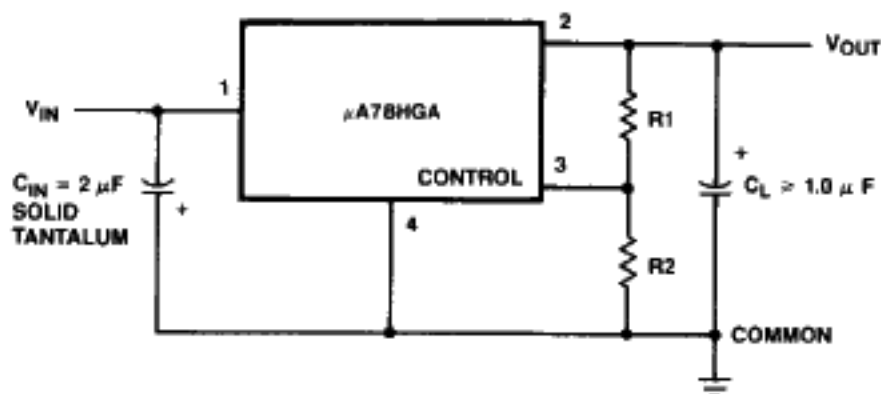

Design Considerations

This device has thermal-overload protection from excessive power and internal short-circuit protection which limits the circuit's maximum current. Thus, the device is protected from overload abnormalities. Although the internal power dissipation is limited, the junction temperature must be kept below the maximum specified temperature (150°C). It is recommended by the manufacturer that the maximum junction temperature be kept as low as possible for increased reliability. To calculate the maximum junction temperature or heat sink required, the following thermal resistance values should be used:

Package	Typ θ _{JC}	Max θ _{JC}
TO-3	1.8	2.5

$$P_{D(MAX)} = \frac{T_{J(max)} - T_A}{\theta_{JC} + \theta_{CA}}$$

$$\theta_{CA} = \theta_{CS} + \theta_{SA}$$

Solving for T_J:

$$T_J = T_A + P_D (\theta_{JC} + \theta_{CA})$$

Where:

- T_J = Junction Temperature
- T_A = Ambient Temperature
- P_D = Power Dissipation
- θ_{JC} = Junction-to-case thermal resistance
- θ_{CA} = Case-to-ambient thermal resistance
- θ_{SA} = Heat sink-to-ambient thermal resistance
- θ_{CS} = Case-to-heat sink thermal resistance

This device is designed to operate without external compensation components. However, the amount of external filtering of this voltage regulator depends upon the circuit layout. If in a specific application the regulator is more than four inches from the filter capacitor, a 1 μF solid tantalum capacitor should be used at the input. A 0.1 μF capacitor should be used at the output to reduce transients created by fast switching loads, as seen in the basic test circuit. These filter capacitors must be located as close to the regulator as possible.

Caution: Permanent damage can result from forcing the output voltage higher than the input voltage. A protection diode from output to input should be used if this condition exists.

Voltage Output

The device has an adjustable output voltage from 5.0 V to 24 V which can be programmed by the external resistor network (potentiometer or two fixed resistors) using the relationship

$$V_{OUT} = V_{CONTROL} \left(\frac{R_1 + R_2}{R_2} \right)$$

Example: If R₁ = 0 Ω and R₂ = 5 kΩ, then

$$V_{OUT} = 5 \text{ V nominal.}$$

Or, if R₁ = 10 kΩ and R₂ = 5 kΩ, then

$$V_{OUT} = 15 \text{ V.}$$