

SHINDENGEN

Super Fast Recovery Rectifiers

Dual

DF20LC20U

200V 20A

FEATURES

SMT
Low noise
trr35ns

APPLICATION

Switching power supply
DC/DC converter
Free Wheel
Home Appliances, Office Equipment
Telecommunication, Factory Automation

OUTLINE DIMENSIONS

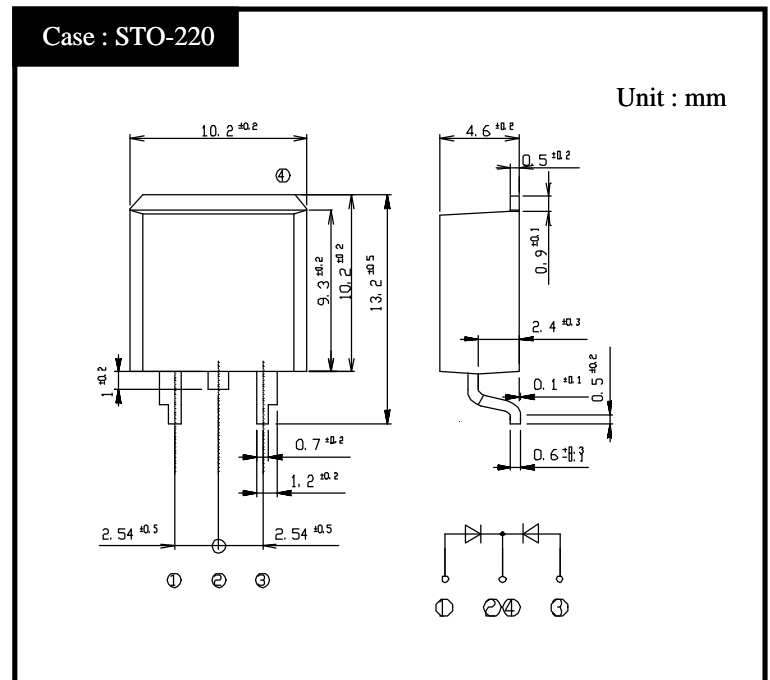

RATINGS

Absolute Maximum Ratings (If not specified Tc=25)

Item	Symbol	Conditions	Ratings	Unit
Storage Temperature	Tstg		-40 ~ 150	
Operating Junction Temperature	Tj		150	
Maximum Reverse Voltage	V _{RM}		200	V
Average Rectified Forward Current	I _O	50Hz sine wave, R-load, Rating for each diode I _O /2, Tc=114	20	A
Peak Surge Forward Current	I _{FSM}	50Hz sine wave, Non-repetitive 1 cycle peak value, Tj=25	140	A

Electrical Characteristics (If not specified Tc=25)

Item	Symbol	Conditions	Ratings	Unit
Forward Voltage	V _F	I _F =10A, Pulse measurement, Rating of per diode	Max.0.98	V
Reverse Current	I _R	V _R =V _{RM} , Pulse measurement, Rating of per diode	Max.10	μA
Reverse Recovery Time	trr	I _F =0.5A, I _R =1A, Rating of per diode	Max.35	ns
Thermal Resistance	jc	junction to case	Max.1.6	/W

DF20LC20U Forward Voltage

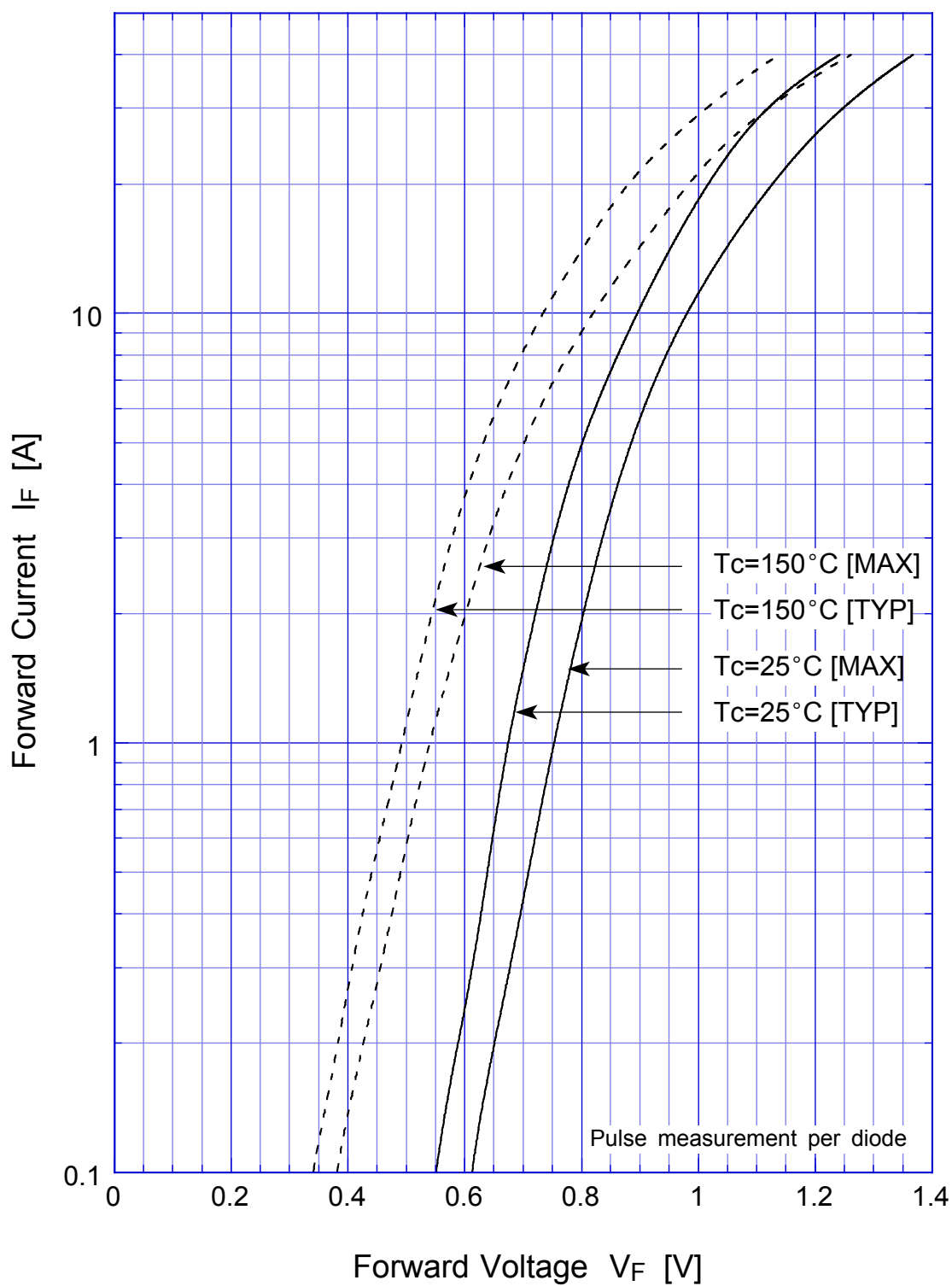

DF20LC20U Forward Power Dissipation

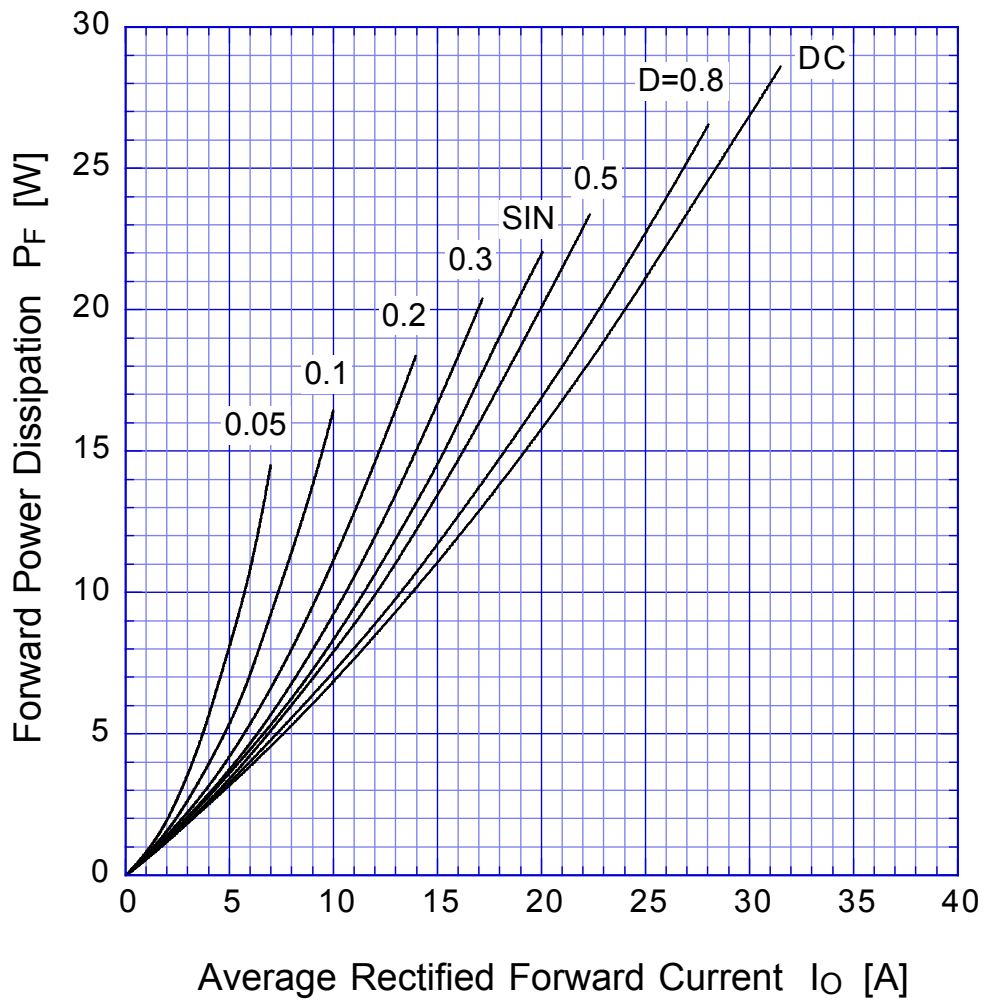

$T_j = T_{jmax}$

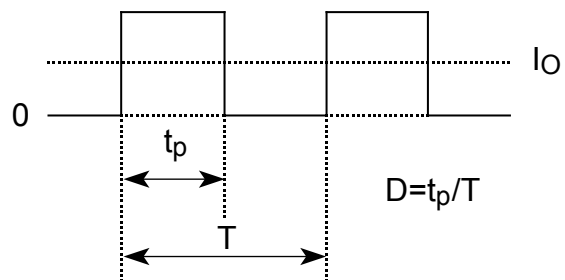

DF20LC20U

Derating Curve

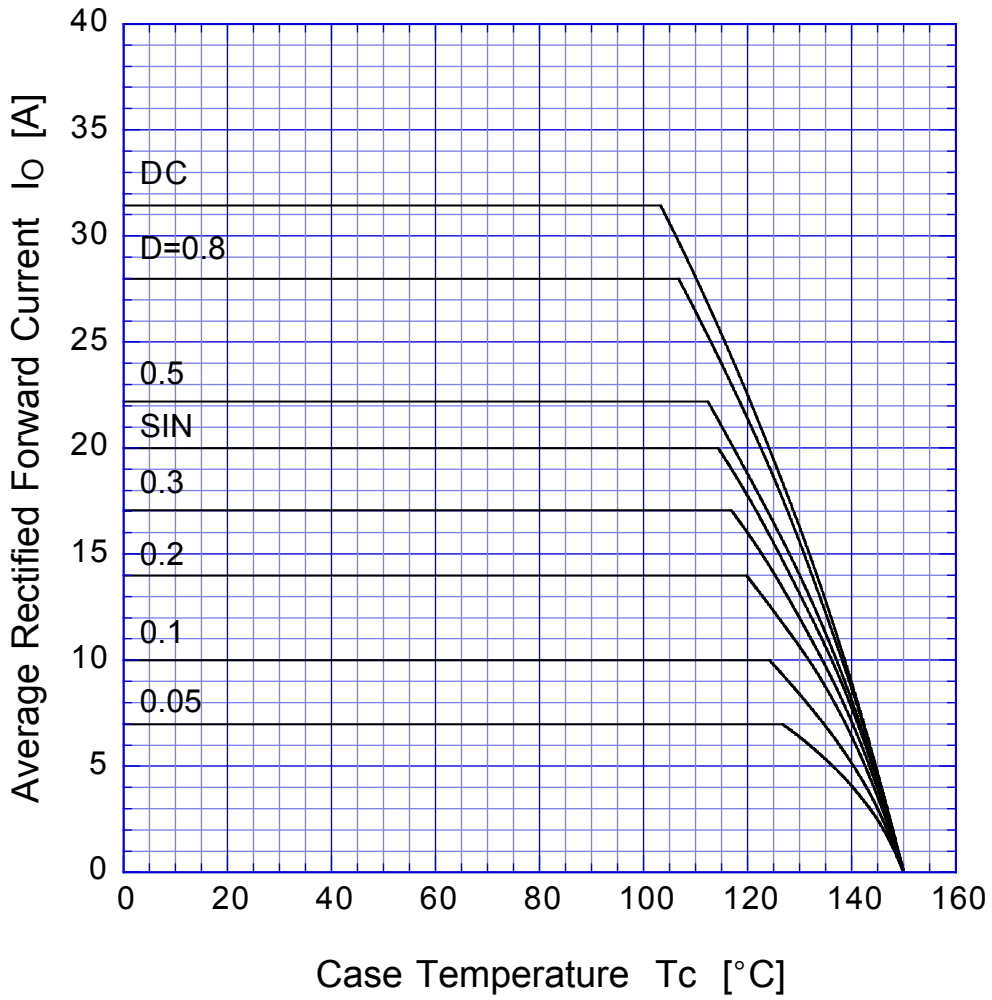

$$V_R = V_{RM}$$

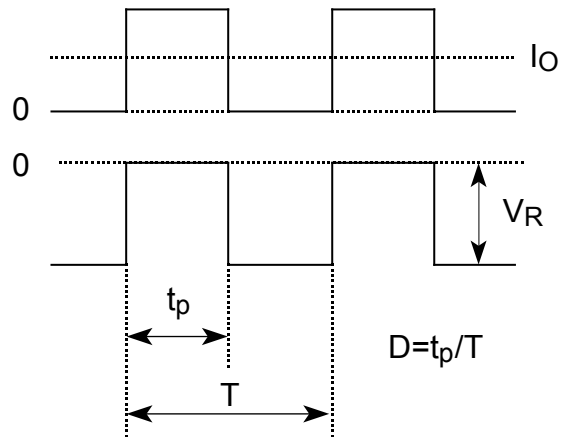

DF20LC20U Peak Surge Forward Capability

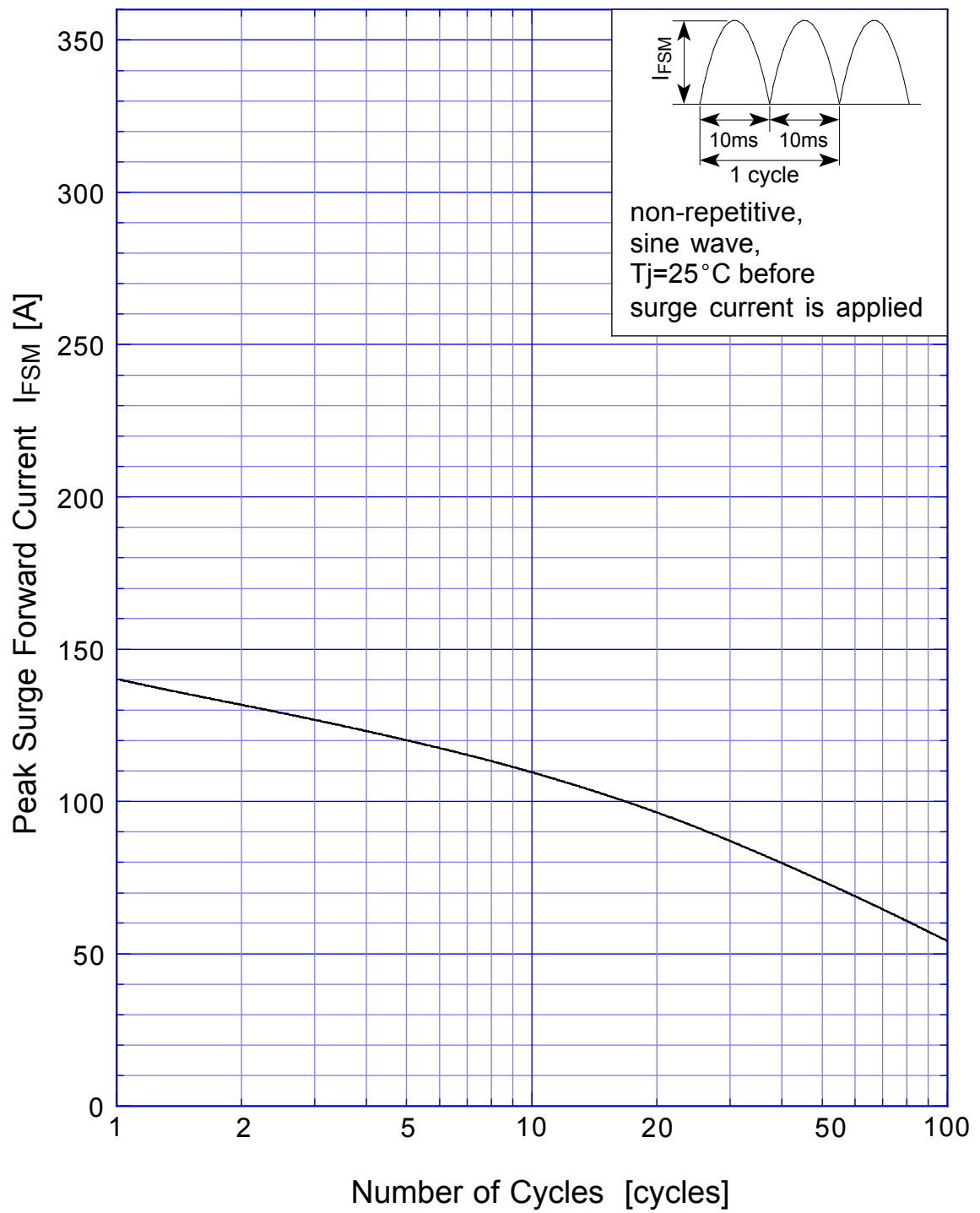

DF20LC20U Junction Capacitance

