

FEATURES

- Data rates up to 2.5Gb/s
- Operating temperature: -40°C to 85°C
- Photosensitive diameter: 30µm
- High cut-off frequency: 3.0GHz at M=5 and 10
- Large gain-bandwidth product: 40GHz
- Low dark current: 20nA
- Low multiplied dark current: 3nA
- Low excess noise factor: 5 at M=10

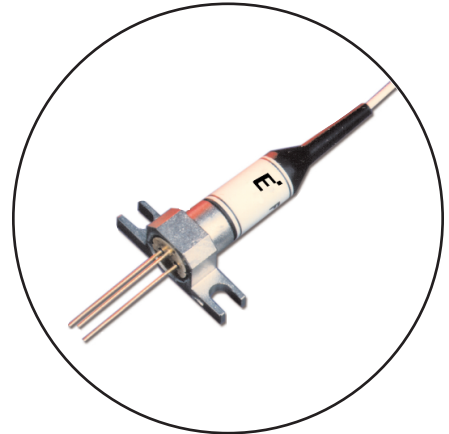

APPLICATIONS

- 2.4 Gb/s optical transmission systems

DESCRIPTION

The FPD5W1KX is a wide bandwidth, high sensitivity avalanche photodiode (APD) optimized for operation at 1550nm. This APD is designed for use in optical transmission systems operating at a giga-bit-rate, above 2.4Gb/s, and for long transmission distances. The APD chip has a photosensitive area diameter of 30µm. Fujitsu's advanced InP material technology realizes a high reliability planar structure device with wide bandwidth (large gain-bandwidth product) as well as low noise characteristics. A single-mode fiber is aligned to a hermetically sealed APD through a highly stable optical coupling system.

ABSOLUTE MAXIMUM RATINGS (T_a=25°C, unless otherwise specified)

Parameter	Symbol	Ratings		Unit
		Min.	Max.	
Storage Temperature	T _{stg}	-40	+85	°C
Operating Temperature	T _{op}	-40	+85	°C
APD Reverse Current	I _R	0	3(peak)	mA
APD Forward Current	I _F	-	10	mA
APD Reverse Voltage	V _R	-	V _B	V

Note: Since V_B may vary from device-to-device, V_B data is attached to each device for reference.

OPTICAL & ELECTRICAL CHARACTERISTICS

($T_a = -40^\circ\text{C}$ to $+85^\circ\text{C}$, $\lambda = 1,310/1,550\text{nm}$, unless otherwise specified)

Parameter	Symbol	Test Conditions		Limits			Unit
				Min.	Typ.	Max.	
APD Responsivity	R	$\lambda = 1,310\text{nm}$, $M=1$, 25°C		0.8	0.85	-	A/W
		$\lambda = 1,550\text{nm}$, $M=1$, 25°C		0.8	0.92	-	
		$\lambda = 1,310/1,550\text{nm}$, $M=1$, $-40 \sim +85^\circ\text{C}$		0.75	-	-	
		$\lambda = 1,610\text{nm}$, $M=1$, 25°C		-	0.7	-	
APD Breakdown Voltage	VB	ID = $10\mu\text{A}$, 25°C		40	50	60	V
Temperature Coefficient of VB	Γ	Note (1)		0.08	0.12	0.15	V/ $^\circ\text{C}$
Dark Current	ID	VR=0.9 x VB	25°C	-	15	40	nA
			70°C	-	-	800	
			85°C	-	-	1700	
Multiplied Dark Current	IDM	M=1	25°C	-	1.5	10	nA
			70°C	-	-	160	
			85°C	-	-	340	
Excess Noise Factor	F (x)	M=10, f=30MHz, B=1MHz, Ipo=2 μA		-	4 (0.6)	6.3 (0.8)	
Cut-off Frequency	fc	RL=50 Ω , -3dB from 500kHz	M=3	2.0	3.0	-	GHz
			M=5, 10	2.5	3.0	-	GHz
			M=20	1.5	3.0	-	GHz
Capacitance	Ct	f=1MHz, VR=0.9 X VB		-	0.55	0.7	pF
Optical Return Loss	ORL	-		30	-	-	dB
Maximum Multiplication Factor	Mmax	Ipo=2 μA		30	40	-	

Note 1: $\Gamma = \Delta\text{VB}/dT_c$

Fig. 1 Responsivity vs. Wavelength

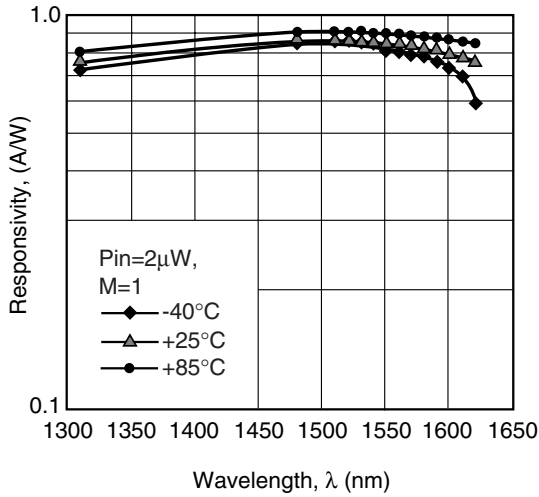

Fig. 2 Responsivity vs. Temperature

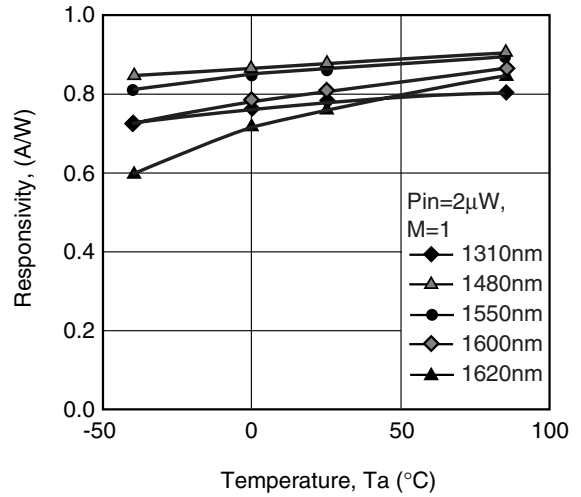

Fig. 3 Dark Current vs. Reverse Voltage

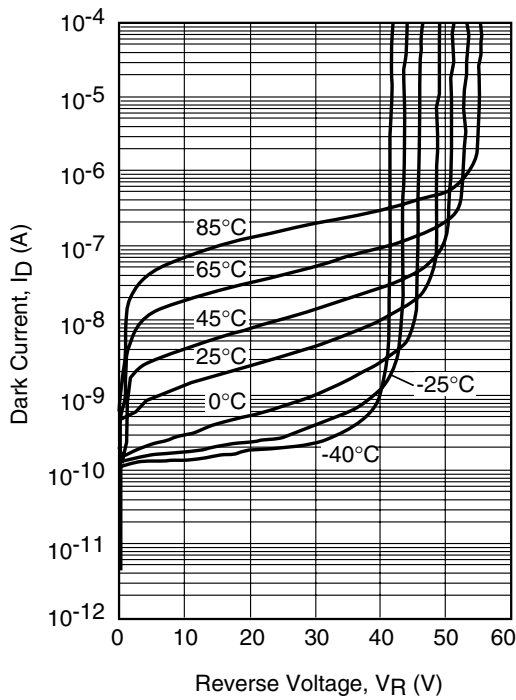

Fig. 5 Multiplication Characteristics

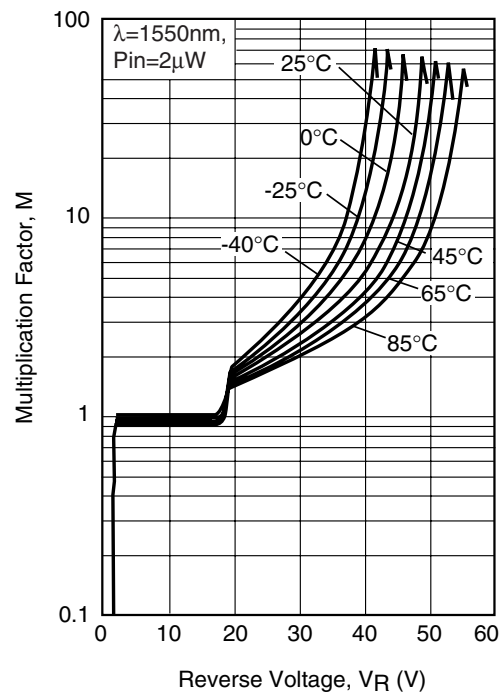

Fig. 6 Multiplication Factor vs. Photocurrent

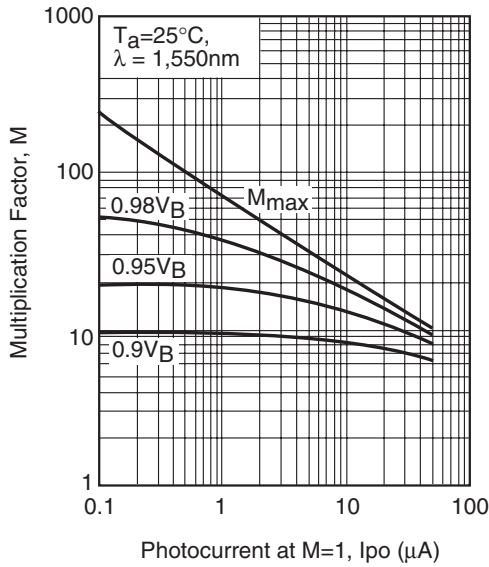

Fig. 7A Frequency Response (Air Gap ~ 2mm)

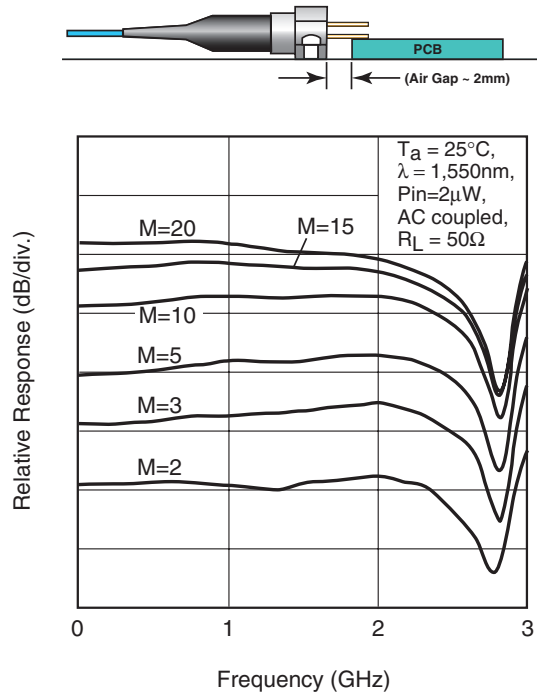

Fig. 7B Frequency Response (Air Gap ~ 0mm)

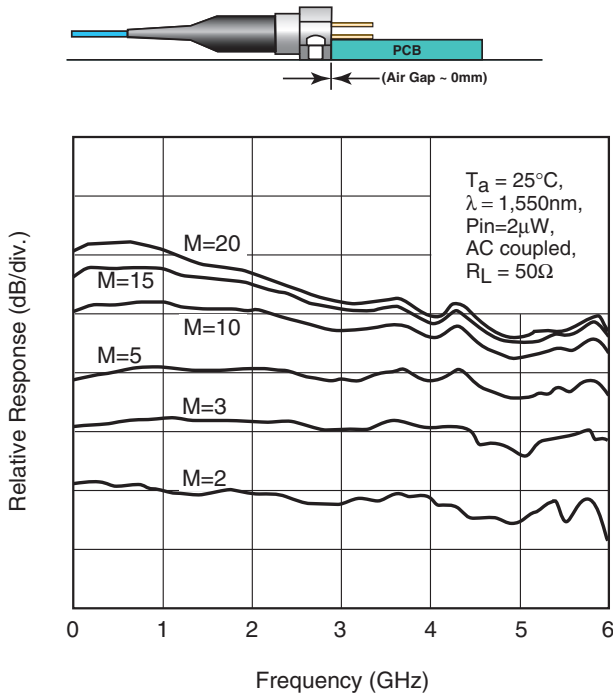

Fig. 8 Cutoff Frequency vs. Multiplication Factor

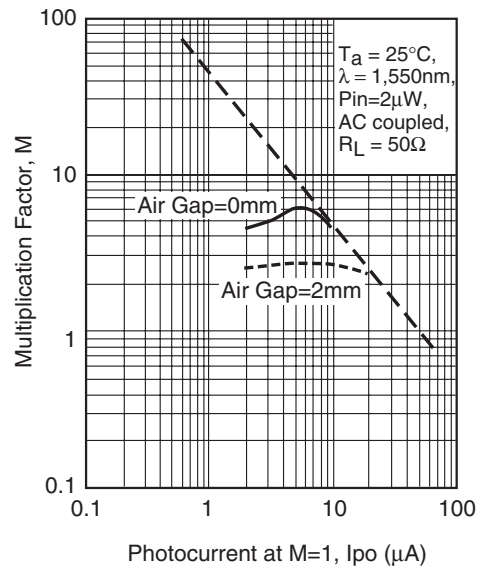

Fig. 9 Temperature Coefficient vs. Breakdown Voltage

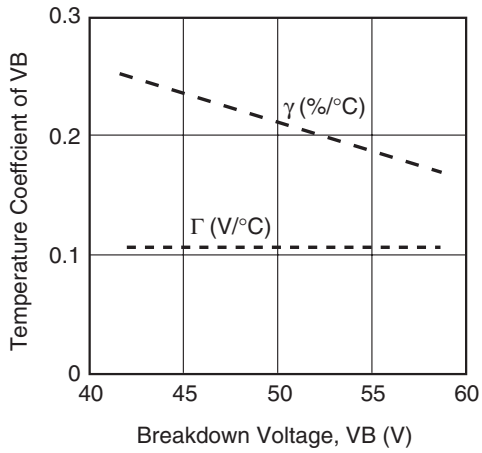

Fig. 10 Excess Noise Factor vs. Multiplication Factor

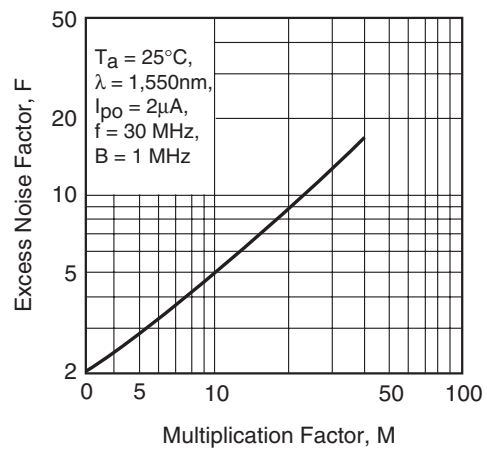
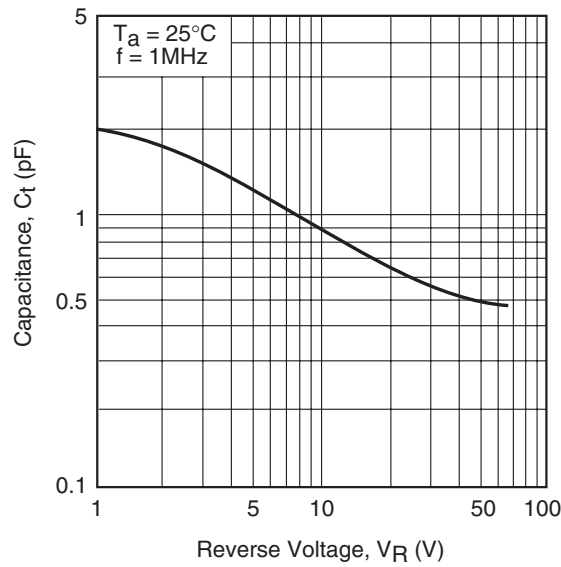
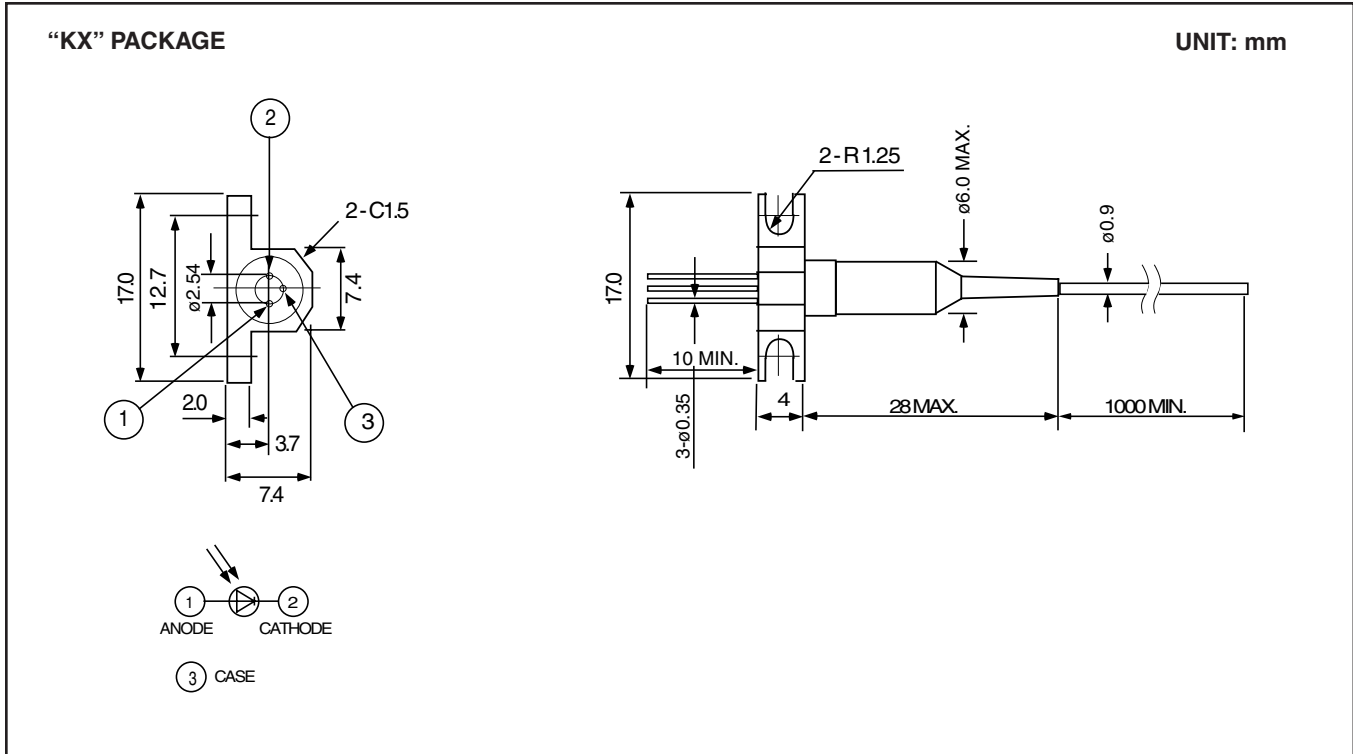

Fig. 11 Capacitance vs. Reverse Voltage





For further information please contact:

Eudyna Devices USA Inc.

2355 Zanker Rd.
San Jose, CA 95131-1138, U.S.A.
TEL: (408) 232-9500
FAX: (408) 428-9111
www.us.eudyna.com

Eudyna Devices Europe Ltd.

Network House
Norreys Drive
Maidenhead, Berkshire SL6 4FJ
United Kingdom
TEL: +44 (0) 1628 504800
FAX: +44 (0) 1628 504888

Eudyna Devices Asia Pte Ltd.

Hong Kong Branch
Rm. 1101, Ocean Centre, 5 Canton Rd.
Tsim Sha Tsui, Kowloon, Hong Kong
TEL: +852-2377-0227
FAX: +852-2377-3921

Eudyna Devices Inc.

Sales Division
1, Kanai-cho, Sakae-ku
Yokohama, 244-0845, Japan
TEL: +81-45-853-8156
FAX: +81-45-853-8170

CAUTION

Eudyna Devices Inc. products contain **gallium arsenide (GaAs)** which can be hazardous to the human body and the environment. For safety, observe the following procedures:

- Do not put this product into the mouth.
- Do not alter the form of this product into a gas, powder, or liquid through burning, crushing, or chemical processing as these by-products are dangerous to the human body if inhaled, ingested, or swallowed.
- Observe government laws and company regulations when discarding this product. This product must be discarded in accordance with methods specified by applicable hazardous waste procedures.

Eudyna Devices Inc. reserves the right to change products and specifications without notice. The information does not convey any license under rights of Eudyna Devices Inc. or others.

© 2004 Eudyna Devices USA Inc.
Printed in U.S.A.