

WIDEBAND POWER AMPLIFIER MODULE, 2 - 20 GHz

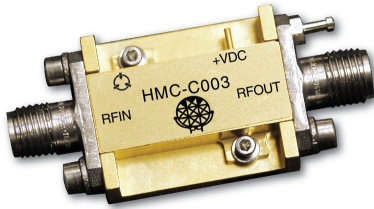

Typical Applications

The HMC-C003 Wideband PA is ideal for:

- Telecom Infrastructure
- Microwave Radio & VSAT
- Military & Space
- Test Instrumentation
- Fiber Optics

Functional Diagram

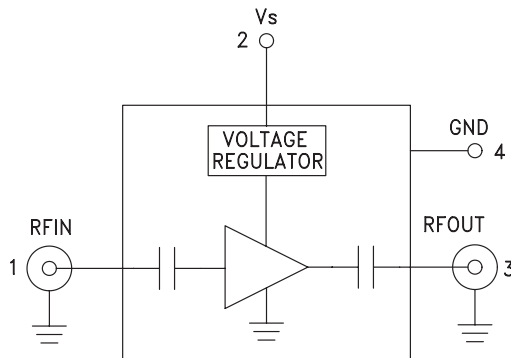

Features

- P1dB Output Power: +26 dBm @ 10 GHz
- Output IP3: +30 dBm
- Gain: 15 dB
- 50 Ohm Matched Input/Output
- Regulated Supply and Bias Sequencing
- Hermetically Sealed Module
- Field Replaceable SMA connectors
- 55 to +85°C Operating Temperature

General Description

The HMC-C003 is a GaAs MMIC PHEMT Distributed Power Amplifier in a miniature, hermetic module with replaceable SMA connectors which operates between 2 and 20 GHz. The self-biased amplifier provides 15 dB of gain, +30 dBm output IP3 and up to +26 dBm of output power at 1 dB gain compression while requiring a single +12V supply. Gain flatness is excellent from 2 - 18 GHz making the HMC-C003 ideal for EW, ECM RADAR and test equipment applications. The wideband amplifier I/Os are internally matched to 50 Ohms and are internally DC blocked.

Electrical Specifications, $T_A = +25^\circ\text{C}$, $V_s = +11.6\text{V}$ to $+12.4\text{V}$

Parameter	Min.	Typ.	Max.	Min.	Typ.	Max.	Min.	Typ.	Max.	Units
Frequency Range	2.0 - 6.0		6.0 - 18.0		18.0 - 20.0					
Gain	13	15		11	14		9	12		dB
Gain Flatness		± 0.25			± 0.75			± 1.0		dB
Gain Variation Over Temperature		0.02	0.03		0.02	0.03		0.02	0.03	dB/°C
Noise Figure		4.0			4.0			6.0		dB
Input Return Loss		17			18			10		dB
Output Return Loss		12			10			12		dB
Output Power for 1 dB Compression (P1dB)	23	26		20	24		19	22		dBm
Saturated Output Power (Psat)		27			25			23		dBm
Output Third Order Intercept (IP3)		34			30			25		dBm
Spurious Response		-50			-60			-60		dBc
Supply Current		310			310			310		mA

**WIDEBAND POWER AMPLIFIER
MODULE, 2 - 20 GHz**

Gain & Return Loss

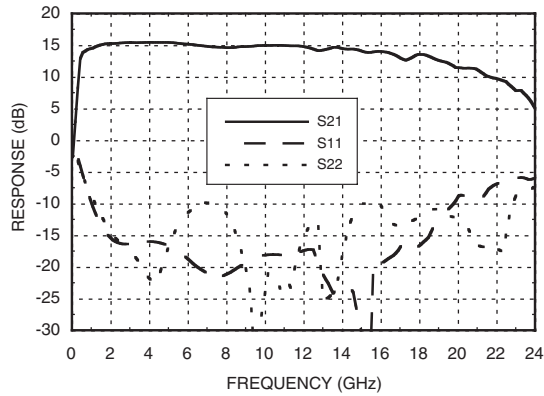

Gain vs. Temperature

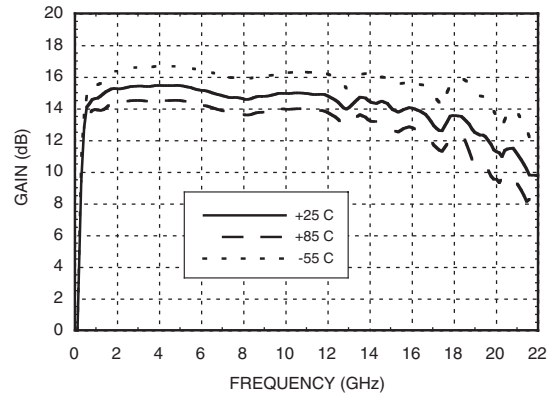

Input Return Loss vs. Temperature

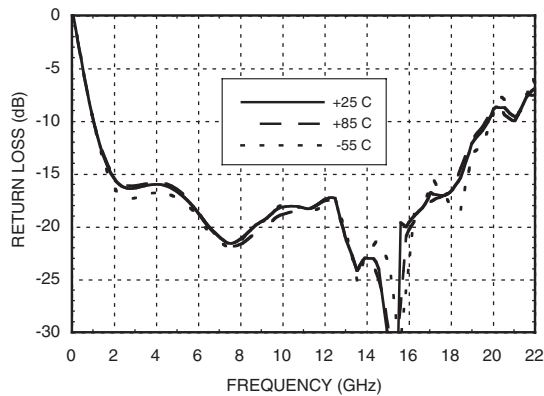

Output Return Loss vs. Temperature

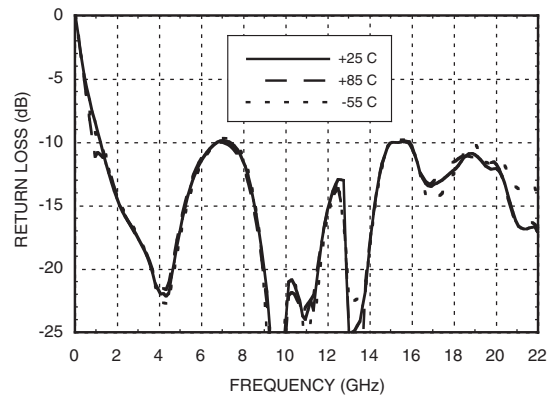

Reverse Isolation vs. Temperature

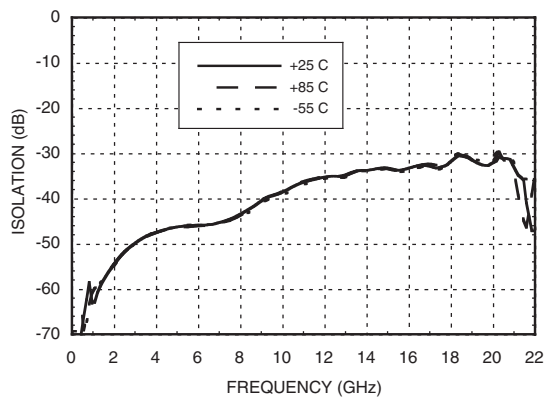

Noise Figure

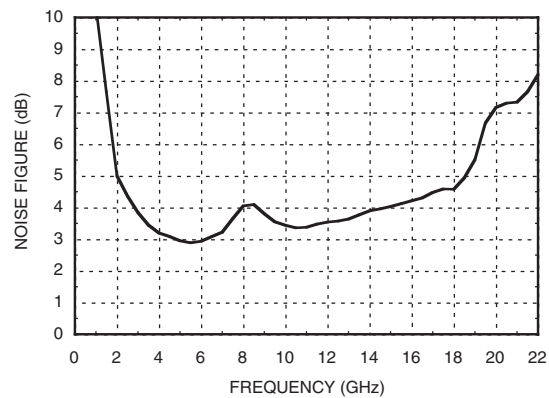

**WIDEBAND POWER AMPLIFIER
MODULE, 2 - 20 GHz**

P1dB vs. Temperature

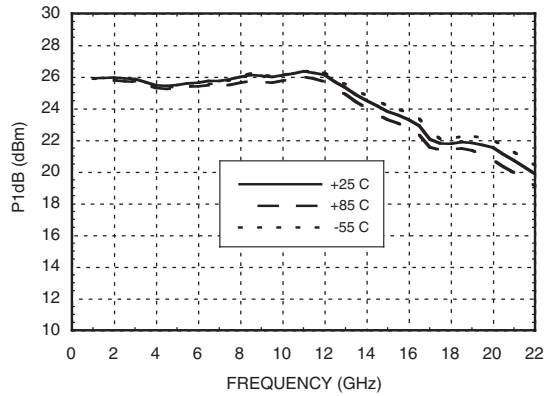

Psat vs. Temperature

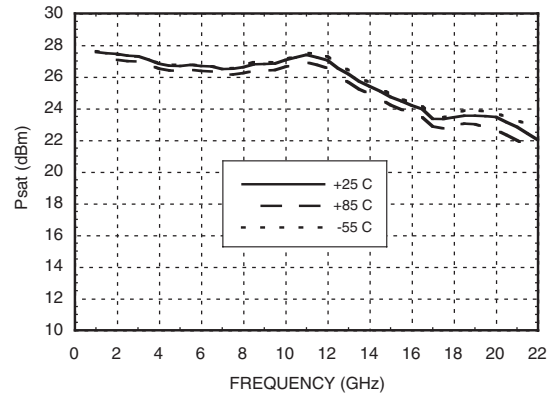

Output IP3 vs. Temperature

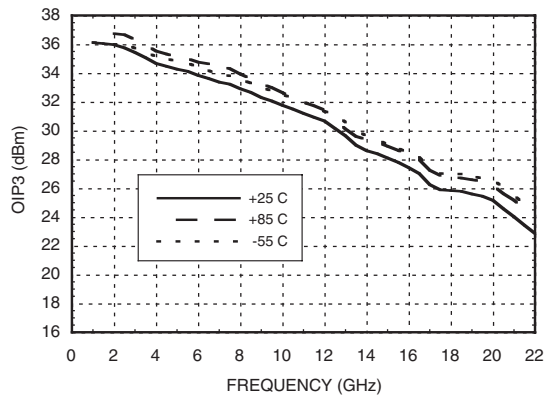



Absolute Maximum Ratings

Bias Supply Voltage (Vs)	+11 Vdc to +13 Vdc
RF Input Power (RFIn)	+23 dBm
Storage Temperature	-65 to +150 °C
Operating Temperature	-55 to +85 °C

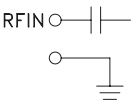
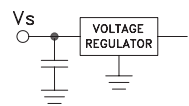
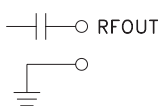

**ELECTROSTATIC SENSITIVE DEVICE
OBSERVE HANDLING PRECAUTIONS**

Pin Descriptions

Pin Number	Function	Description	Interface Schematic
1	RFIN & RF Ground	RF input connector, SMA female, field replaceable. This pin is AC coupled and matched to 50 Ohms from 2.0 - 20.0 GHz.	
2	Vs	Power supply voltage for the amplifier.	
3	RFOUT & RF Ground	RF output connector, SMA female. This pin is AC coupled and matched to 50 Ohms from 2.0 - 20.0 GHz.	
4	GND	Power supply ground.	

**WIDEBAND POWER AMPLIFIER
MODULE, 2 - 20 GHz**

Outline Drawing

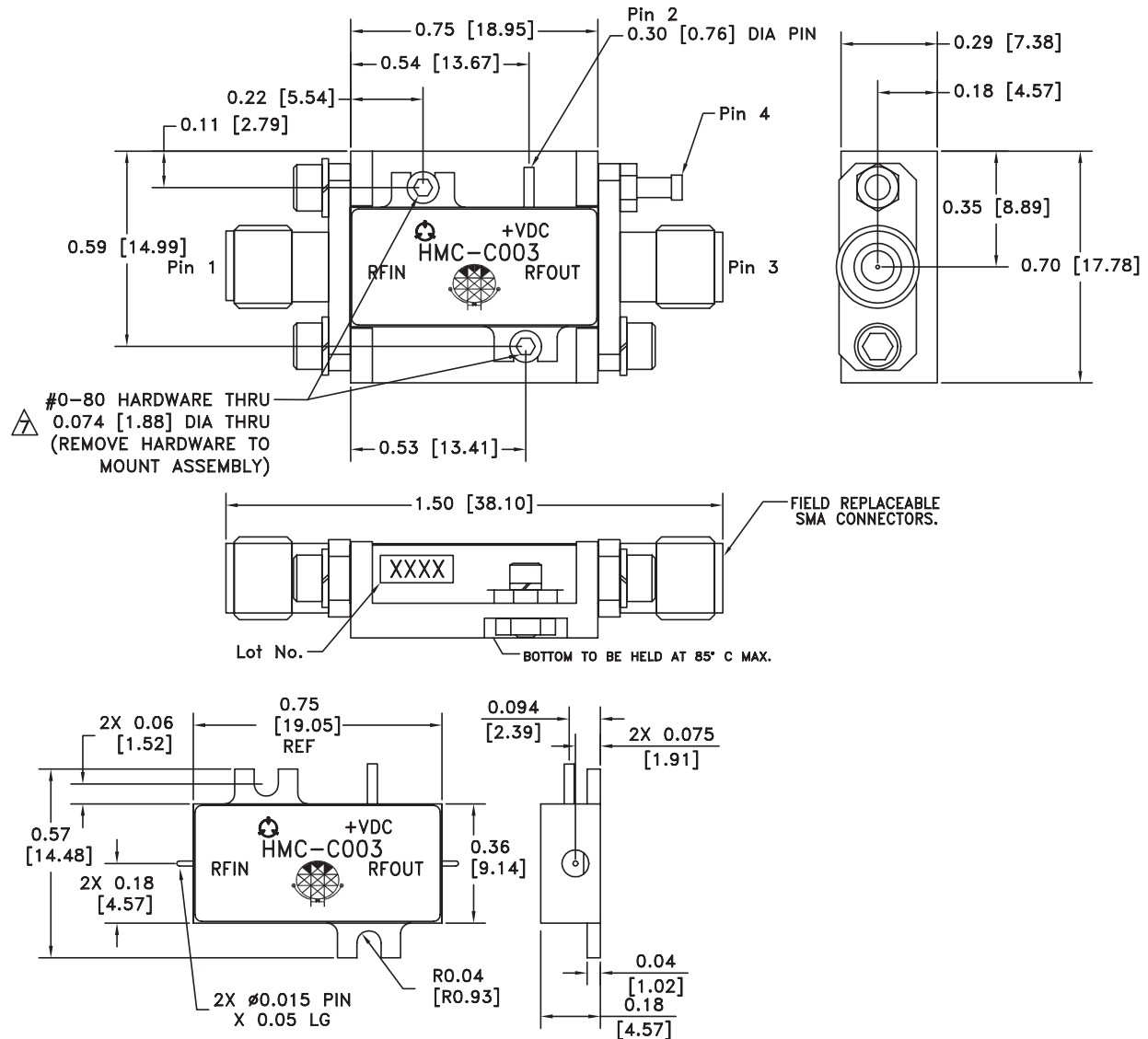

NOTES:

1. PACKAGE, LEADS, COVER MATERIAL: KOVART™
 2. BRACKET MATERIAL: ALUMINUM
 3. PLATING: ELECTROLYTIC GOLD 50 MICROINCHES MIN., OVER ELECTROLYTIC NICKEL 75 MICROINCHES MIN.
 4. ALL DIMENSIONS ARE IN INCHES [MILLIMETERS].
 5. TOLERANCES ±.005 [0.13] UNLESS OTHERWISE SPECIFIED.
 6. FIELD REPLACEABLE SMA CONNECTORS.
TENSOLITE 5602 - 5CCSF OR EQUIVALENT.
- ⚠ TO MOUNT MODULE TO SYSTEM PLATFORM REPLACE 0 - 80 HARDWARE WITH DESIRED MOUNTING SCREWS.