



HSB1386J

LOW FREQUENCY TRANSISTOR (-20V, -4A)

Features

- Low $V_{CE(sat)}$
 $V_{CE(sat)} = -0.55V$ (Typ.) ($I_C/I_B = -4A/-0.1A$)
- Excellent DC current gain characteristics.

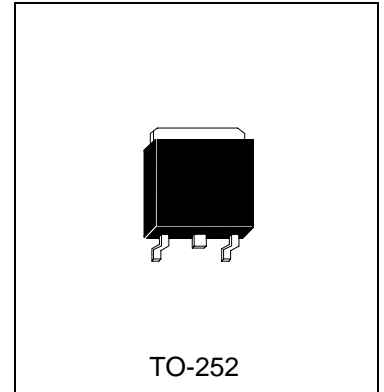

Structure

Epitaxial planar type PNP silicon transistor

Absolute Maximum Ratings ($T_A = 25^\circ C$)

Symbol	Parameter	Limits	Unit
V_{CBO}	Collector-Base Voltage	-30	V
V_{CEO}	Collector-Emitter Voltage	-20	V
V_{EBO}	Emitter-Base Voltage	-6	V
I_C	Collector Current	-4	A
		-10	A(Pulse)*
P_D	Collector Power Dissipation ($T_C = 25^\circ C$)	20	W
T_j	Junction Temperature	150	$^\circ C$
T_{stg}	Storage Temperature	-55~+150	$^\circ C$

Electrical Characteristics ($T_A = 25^\circ C$)

Symbol	Parameter	Min.	Typ.	Max.	Unit	Test Conditions
BV_{CBO}	Collector-Base Breakdown Voltage	-30	-	-	V	$I_C = -50\mu A$
BV_{CEO}	Collector-Emitter Breakdown Voltage	-20	-	-	V	$I_C = -1mA$
BV_{EBO}	Emitter-Base Breakdown Voltage	-6				$I_C = -50\mu A$
I_{CBO}	Collector Cutoff Current	-	-	-0.5	μA	$V_{CB} = -20V$
I_{EBO}	Emitter Cutoff Current	-	-	-0.5	μA	$V_{EB} = -5V$
$*V_{CE(sat)}$	Collector-Emitter Saturation Voltage	-	-	-1	V	$I_C/I_B = -4A/-0.1A$
$*hFE$	DC Current Transfer Ratio	82	-	580		$V_{CE} = -2V, I_C = -0.5A$
fT	Transition Frequency	-	110	-	MHz	$V_{CE} = -6V, I_E = 50mA, f = 30MHz$
Cob	Output Capacitance	-	30	-	pF	$V_{CB} = -20V, I_E = 0A, f = 1MHz$

*Pulse Test: Pulse Width $\leq 380\mu s$, Duty Cycle $\leq 2\%$

Classification Of hFE

Rank	P	Q	R	E
Range	82-180	120-270	180-390	370-580



Characteristics Curve

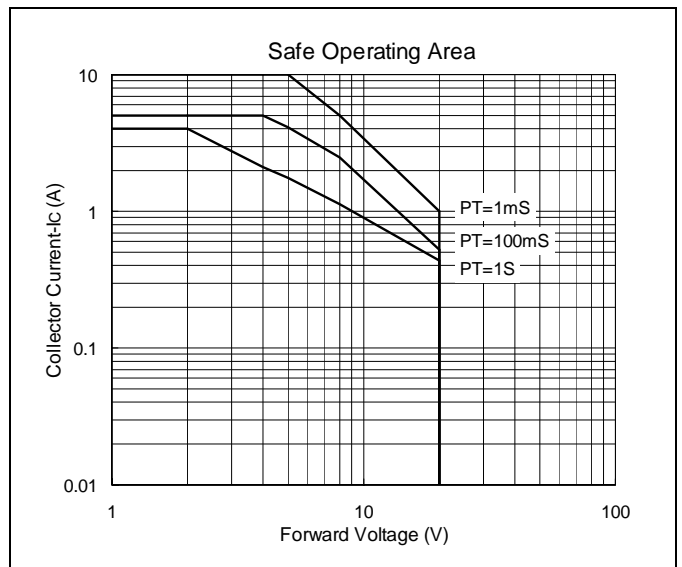
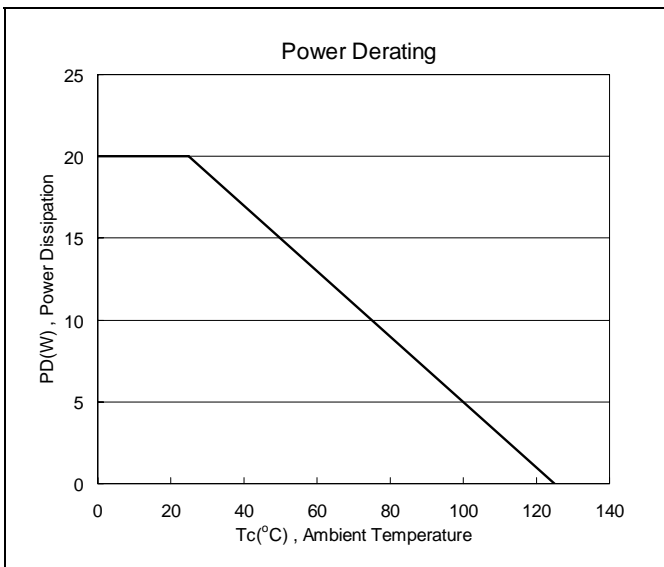
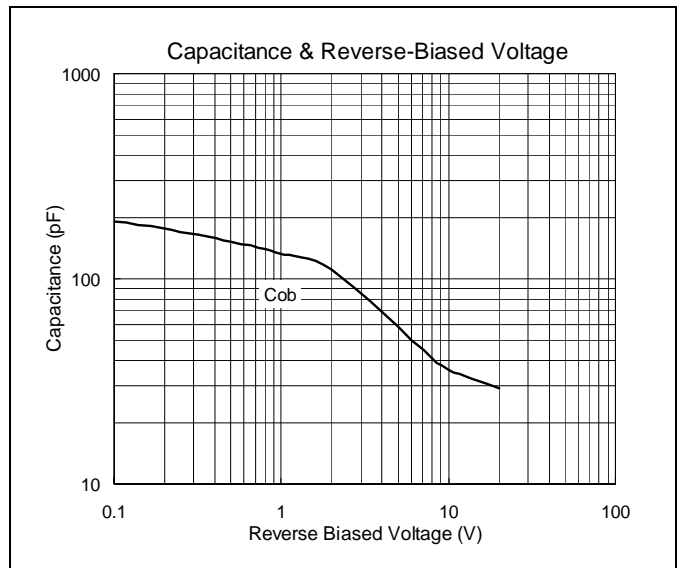
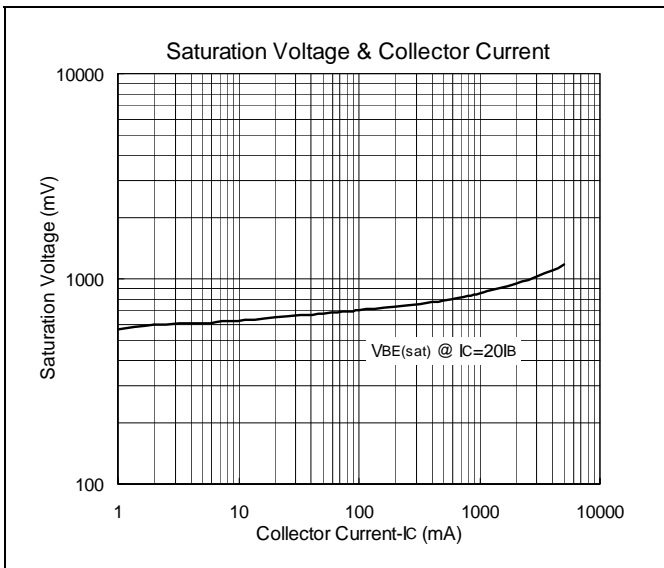
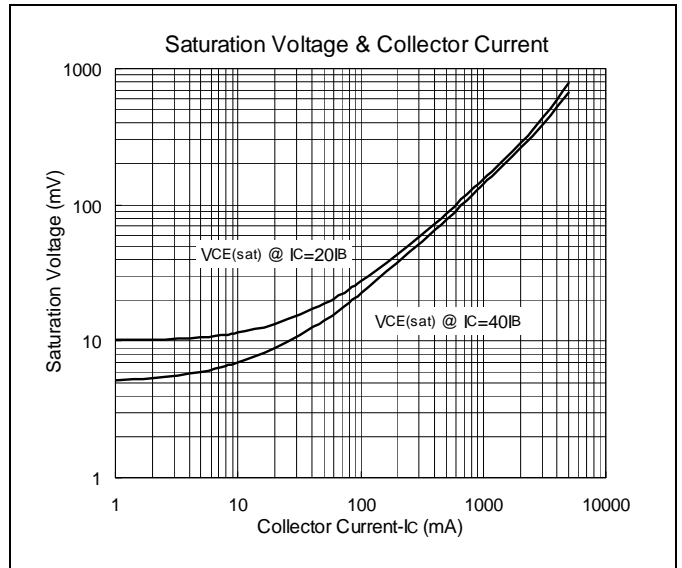
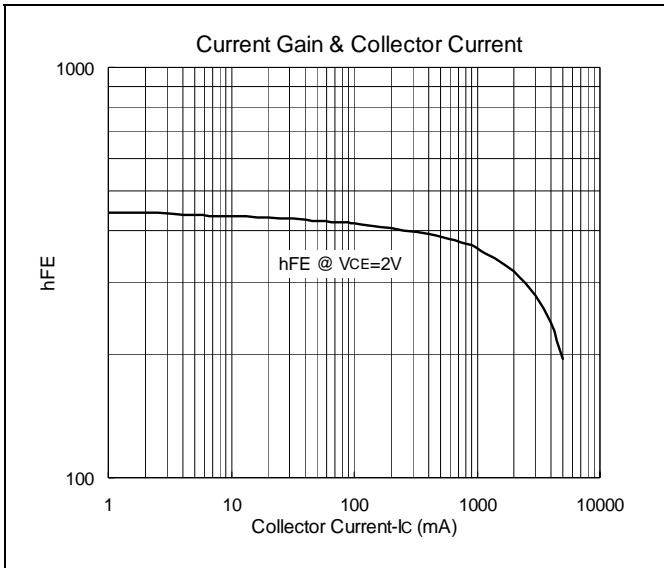



TO-252 Dimension

Marking:

Pb Free Mark
 Pb-Free: "●" (Note)
 Normal: None

Note: Green label is used for pb-free packing

Pin Style: 1.Base 2.Collector 3.Emitter

Material:

- Lead solder plating: Sn60/Pb40 (Normal), Sn/3.0Ag/0.5Cu or Pure-Tin (Pb-free)
- Mold Compound: Epoxy resin family, flammability solid burning class: UL94V-0

DIM	Min.	Max.
A	6.35	6.80
C	4.80	5.50
F	1.30	1.70
G	5.40	6.25
H	2.20	3.00
L	0.40	0.90
M	2.20	2.40
N	0.90	1.50
a1	0.40	0.65
a2	-	*2.30
a5	0.65	1.05

*: Typical, Unit: mm

3-Lead TO-252 Plastic Surface Mount Package
 HSMC Package Code: J

Marking:

Pb Free Mark
 Pb-Free: "●" (Note)
 Normal: None

Note: Green label is used for pb-free packing

Pin Style: 1.Base 2.Collector 3.Emitter

Material:

- Lead solder plating: Sn60/Pb40 (Normal), Sn/3.0Ag/0.5Cu or Pure-Tin (Pb-free)
- Mold Compound: Epoxy resin family, flammability solid burning class: UL94V-0

DIM	Min.	Max.
A	6.40	6.80
B	-	6.00
C	5.04	5.64
D	-	*4.34
E	0.40	0.80
F	0.50	0.90
G	5.90	6.30
H	2.50	2.90
I	9.20	9.80
J	0.60	1.00
K	-	0.96
L	0.66	0.86
M	2.20	2.40
N	0.70	1.10
O	0.82	1.22
a1	0.40	0.60
a2	2.10	2.50
y1	-	5°
y2	-	3°

*: Typical, Unit: mm

3-Lead TO-252 Plastic Surface Mount Package
 HSMC Package Code: J

Important Notice:

- All rights are reserved. Reproduction in whole or in part is prohibited without the prior written approval of HSMC.
- HSMC reserves the right to make changes to its products without notice.
- **HSMC semiconductor products are not warranted to be suitable for use in Life-Support Applications, or systems.**
- HSMC assumes no liability for any consequence of customer product design, infringement of patents, or application assistance.

Head Office And Factory:

- **Head Office** (Hi-Sincerity Microelectronics Corp.): 10F., No. 61, Sec. 2, Chung-Shan N. Rd. Taipei Taiwan R.O.C.
 Tel: 886-2-25212056 Fax: 886-2-25632712, 25368454
- **Factory 1:** No. 38, Kuang Fu S. Rd., Fu-Kou Hsin-Chu Industrial Park Hsin-Chu Taiwan. R.O.C
 Tel: 886-3-5983621~5 Fax: 886-3-5982931



Soldering Methods for HSMC's Products

1. Storage environment: Temperature=10°C~35°C Humidity=65%±15%
2. Reflow soldering of surface-mount devices

Figure 1: Temperature profile

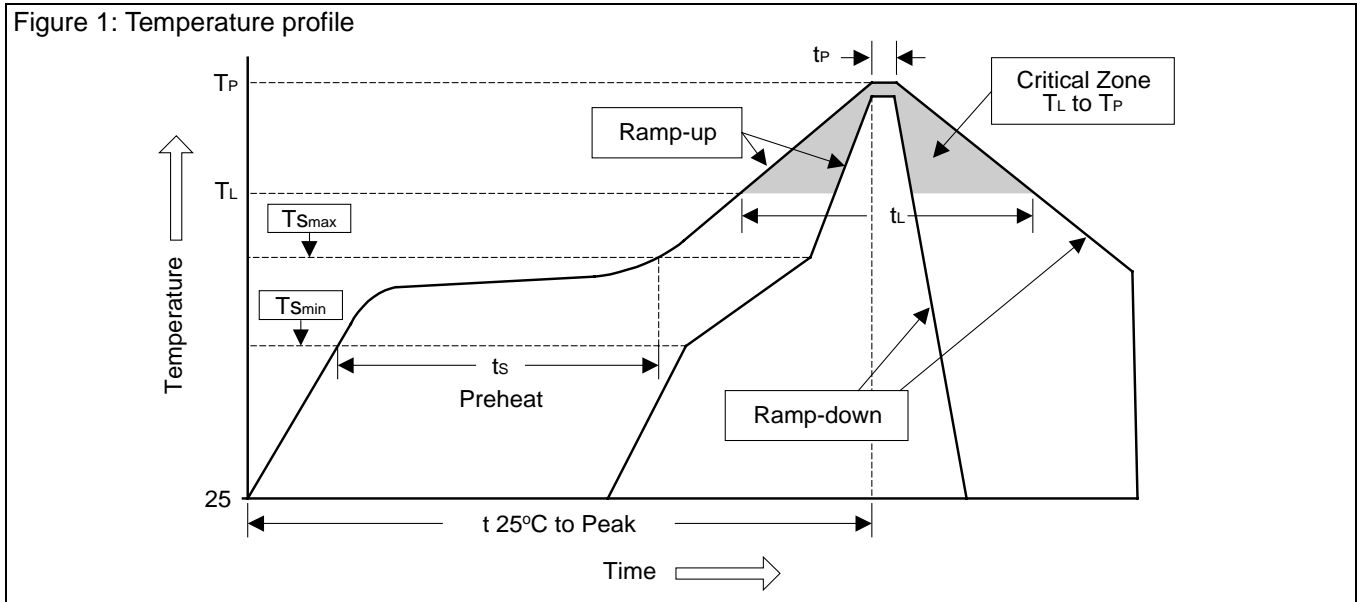

Profile Feature	Sn-Pb Eutectic Assembly	Pb-Free Assembly
Average ramp-up rate (T_L to T_P)	<3°C/sec	<3°C/sec
Preheat		
- Temperature Min (T_{Smin})	100°C	150°C
- Temperature Max (T_{Smax})	150°C	200°C
- Time (min to max) (t_s)	60~120 sec	60~180 sec
T_{Smax} to T_L		
- Ramp-up Rate	<3°C/sec	<3°C/sec
Time maintained above:		
- Temperature (T_L)	183°C	217°C
- Time (t_L)	60~150 sec	60~150 sec
Peak Temperature (T_P)	240°C +0/-5°C	260°C +0/-5°C
Time within 5°C of actual Peak Temperature (t_P)	10~30 sec	20~40 sec
Ramp-down Rate	<6°C/sec	<6°C/sec
Time 25°C to Peak Temperature	<6 minutes	<8 minutes

3. Flow (wave) soldering (solder dipping)

Products	Peak temperature	Dipping time
Pb devices.	245°C ±5°C	5sec ±1sec
Pb-Free devices.	260°C +0/-5°C	5sec ±1sec