

Absolute Maximum Ratings (Ta=25°C)

Absolute maximum ratings indicate sustained limits beyond which damage to the device may occur. All voltage parameters are absolute voltages referenced to terminals stated, all currents are defined positive into any lead. The thermal resistance and power dissipation ratings are measured under board mounted and still air conditions.

| Symbol | Definition | Terminal s | Max. Ratings | Units | Note |
|--------|--|---------------|--------------|-------|--|
| IDpeak | Drain Current * 1 | 1 - 3 | 15 | A | Single Pulse |
| IDMAX | Maximum switching current *2 | 1 - 3 | 15 | A | Ta=-20~+125°C |
| EAS | Single pulse avalanche energy *3 | 1 - 3 | 292 | mJ | Single Pulse |
| | | | | | VDD=99V,L=20mH |
| | | | | | ILpeak=5.1A |
| VCC | Input voltage for control part | 4 - 3 | 35 | V | |
| VSSOLP | SS/OLP pin voltage | 5 - 3 | -0.5 ~ 6.0 | V | |
| IFB | FB pin inflow current | 6- 3 | 10 | mA | |
| VFB | FB pin voltage | 6- 3 | -0.5 ~ 9.0 | V | within the limits of IFB |
| VOCPCB | O.C.P/F.B pin voltage | 7- 3 | -1.5 ~ 5.0 | V | |
| PD1 | Power dissipation of MOSFET *4 | 1 - 3 | 28.0 | W | With infinite heatsink |
| | | | 1.1 | | Without heatsink |
| PD2 | Power dissipation for control part (MIC) | 4 - 3 | 0.8 | W | Specified by Vcc x Icc |
| TF | Internal frame temperature in operation | - | -20 ~ +115 | °C | Refer to recommended operating temperature |
| Top | Operating ambient temperature | - | -20 ~ +115 | °C | |
| Tstg | Storage temperature | - | -40 ~ +125 | °C | |
| Tch | Channel temperature | - | 150 | °C | |

*1 Refer to MOS FET A.S.O. curve

*2 Maximum switching current

The maximum switching current is the Drain current determined by the drive voltage of the IC and threshold voltage (Vth) of the MOS FET.

*3 Refer to MOS FET Tch-EAS curve

*4 Refer to MOS FET Ta-PD1 curve

Electrical Characteristics (for Control IC)

Electrical characteristics for control part (Ta=25°C, Vin=20V, unless otherwise specified)

| Symbol | Definition | Terminals | Ratings | | | Units | Note |
|--|---------------------------------------|-----------|---------|------|------|-------|--------------------------------|
| | | | MIN | TYP | MAX | | |
| Power Supply Start-up Operation | | | | | | | |
| $V_{CC(ON)}$ | Operation Start Voltage | 4 - 3 | 16.3 | 18.2 | 19.9 | V | V _{cc} =0→19.9V |
| $V_{CC(OFF)}$ | Operation Stop Voltage | 4 - 3 | 8.8 | 9.7 | 10.6 | V | V _{cc} =19.9→8.8 V |
| $I_{CC(ON)}$ | Circuit Current in Operation | 4 - 3 | - | - | 6 | mA | - |
| $I_{CC(OFF)}$ | Circuit Current in Non-Operation | 4 - 3 | - | - | 100 | μA | V _{cc} =15V |
| f _{osc} | Oscillation Frequency | 1 - 3 | 19 | 22 | 25 | kHz | - |
| $V_{SSOLP(SS)}$ | Soft Start Operation Stop Voltage | 5 - 3 | 1.1 | 1.2 | 1.4 | V | - |
| $I_{SSOLP(SS)}$ | Soft Start Operation Charging Current | 5 - 3 | -710 | -550 | -390 | μA | - |

| Normal Operation | | | | | | | |
|-------------------------|--|-------|--------|--------|--------|----|---|
| $V_{OCPBD(BS1)}$ | Bottom-Skip Operation Threshold Voltage1 | 7 - 3 | -0.72 | -0.665 | -0.605 | V | - |
| $V_{OCPBD(BS2)}$ | Bottom-Skip Operation Threshold Voltage2 | 7 - 3 | -0.485 | -0.435 | -0.385 | V | - |
| $V_{OCPBD(LIM)}$ | Overcurrent Detection Threshold Voltage | 7 - 3 | -0.995 | -0.94 | -0.895 | V | - |
| I_{OCPBD} | OCP/BD Pin Outflow Current | 7 - 3 | -250 | -100 | -40 | μA | - |
| $V_{OCPBD(TH1)}$ | Quasi-Resonant Operation Threshold Voltage 1 | 7 - 3 | 0.28 | 0.4 | 0.52 | V | - |
| $V_{OCPBD(TH2)}$ | Quasi-Resonant Operation Threshold Voltage 2 | 7 - 3 | 0.67 | 0.8 | 0.93 | V | - |
| $V_{FB(OFF)}$ | FB Pin Threshold Voltage | 6 - 3 | 1.32 | 1.45 | 1.58 | V | - |
| $I_{FB(ON)}$ | FB Pin Inflow Current (Normal Operation) | 6 - 3 | 600 | 1000 | 1400 | μA | - |

IRIS-W6754

Electrical Characteristics (for Control IC), Contd.

| Stand-by Operation | | | | | | | |
|----------------------|---|-------|------|------|------|-----------|--|
| $V_{CC(S)}$ | Stand-by Operation Start Voltage | 4 - 3 | 10.3 | 11.1 | 12.1 | V | $V_{CC}=0 \rightarrow 12.2V$ |
| $V_{CC(SK)}$ | Stand-by Operation Start Voltage Interval | 4 - 3 | 1.1 | 1.35 | 1.65 | V | - |
| $I_{CC(S)}$ | Stand-by Non-Operation Circuit Current | 4 - 3 | - | 20 | 56 | μA | $V_{CC}=10.2V$ |
| $I_{FB(S)}$ | FB Pin Inflow Current (Stand-by) | 6 - 3 | - | 4 | 14 | μA | $V_{CC}=10.2V$ |
| $V_{FB(S)}$ | Stand-by Operation FB Pin Threshold Voltage | 6 - 3 | 0.55 | 1.1 | 1.5 | V | $V_{CC}=12.2V$ |
| $T_{ON(MIN)}$ | Minimum ON Time | 1 - 3 | 0.5 | 0.8 | 1.1 | μSec | - |
| Protection Operation | | | | | | | |
| $T_{ON(MAX)}$ | Maximum ON Time | 1 - 3 | 27.5 | 32.5 | 39 | μSec | - |
| $V_{SSOLP(OLP)}$ | OLP Operation Threshold Voltage | 5 - 3 | 4 | 4.9 | 5.8 | V | - |
| $I_{SSOLP(OLP)}$ | OLP Operation Charging Current | 5 - 3 | -16 | -11 | -6 | μA | - |
| $V_{CC(OVP)}$ | OVP Operation Voltage | 4 - 3 | 25.5 | 27.7 | 29.9 | V | $V_{CC}=0 \rightarrow 29.9V$ |
| $I_{CC(H)}$ | Latch Circuit Holding Current *5 | 4 - 3 | -- | 45 | 140 | μA | $V_{CC}=29.9 \rightarrow V_{CC(OFF)}-0.3V$ |
| VCC(La.OFF) | Latch Circuit Release Voltage *5 | 4 - 3 | 6 | 7.2 | 8.5 | V | $V_{CC}=29.9 \rightarrow 6V$ |

*5 The latch circuit means a circuit operated O.V.P and O.L.P.

*6 The current ratings are based on those of the IC , and plus(+) represents sink and minus(-) represents source.

Electrical characteristics for MOSFET (Ta=25 deg C)

| Symbol | Definition | Terminals | Ratings | | | Units | Note |
|---------------------|-----------------------------------|-----------|---------|-----|------|-------|------------------------------------|
| | | | MIN | TYP | MAX | | |
| V _{DSS} | Drain-to-Source breakdown voltage | 1 - 3 | 650 | - | - | V | I _D =300μA |
| I _{DSS} | Drain leakage current | 1 - 3 | - | - | 300 | μA | V _{DS} =650V |
| R _{DS(ON)} | On-resistance | 1 - 3 | - | - | 0.96 | Ω | I _D =1.9A |
| t _f | Switching time | 1 - 3 | - | - | 400 | nSec | - |
| θ ch-F | Thermal resistance | - | - | - | 1.6 | °C/W | Between channel and internal frame |

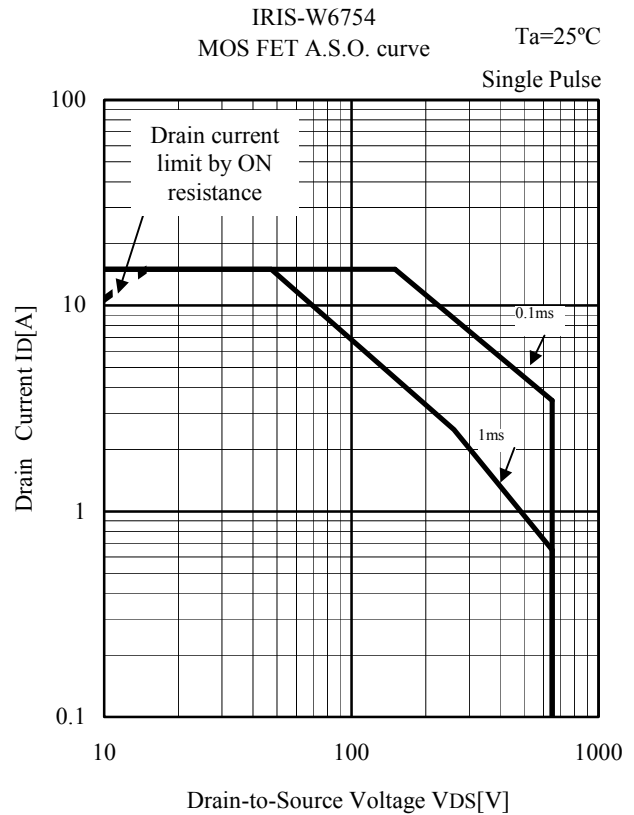
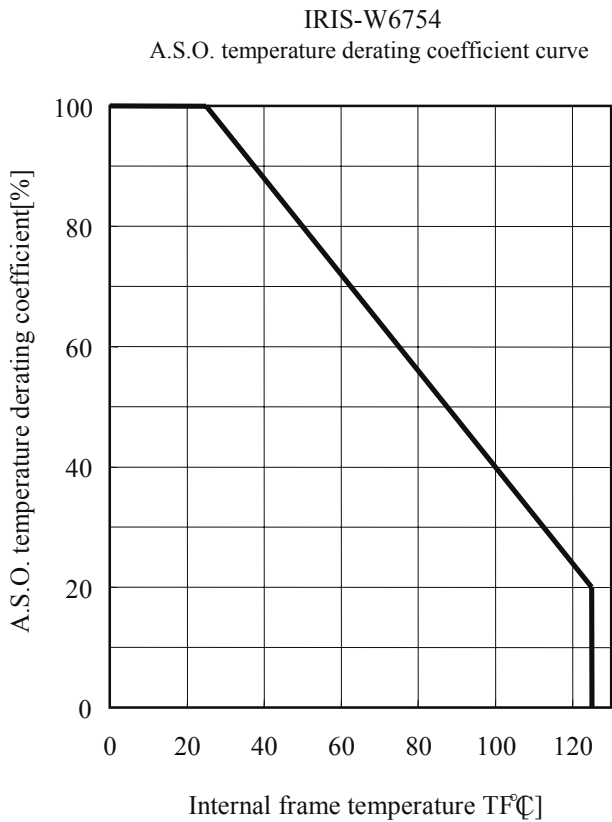

IRIS-W6754

IRIS-W6754
MOSFET Ta-PD1 Curve

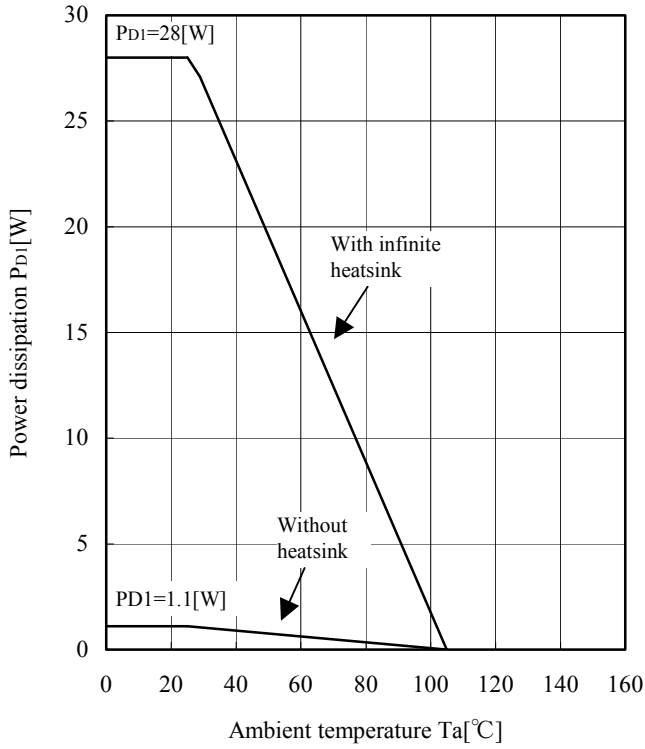

IRIS-W6754
Avalanche energy derating curve

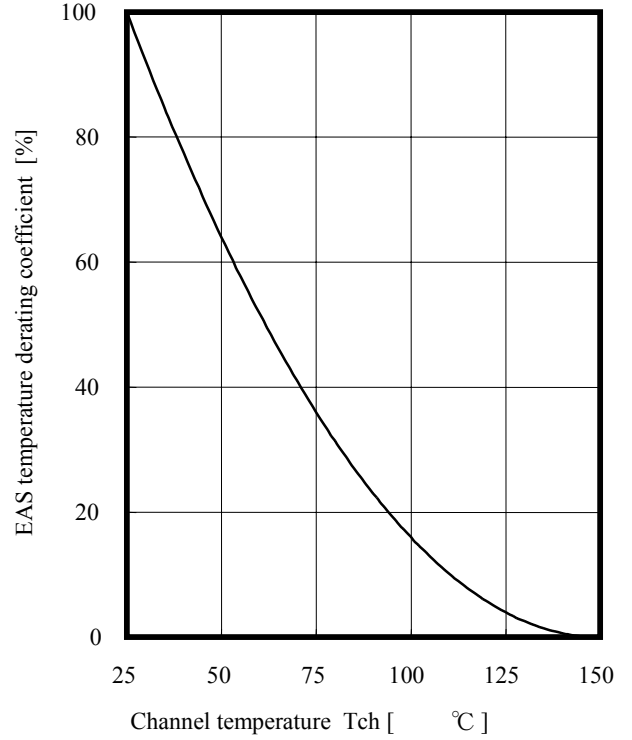

IRIS-W6754
Transient thermal resistance curve

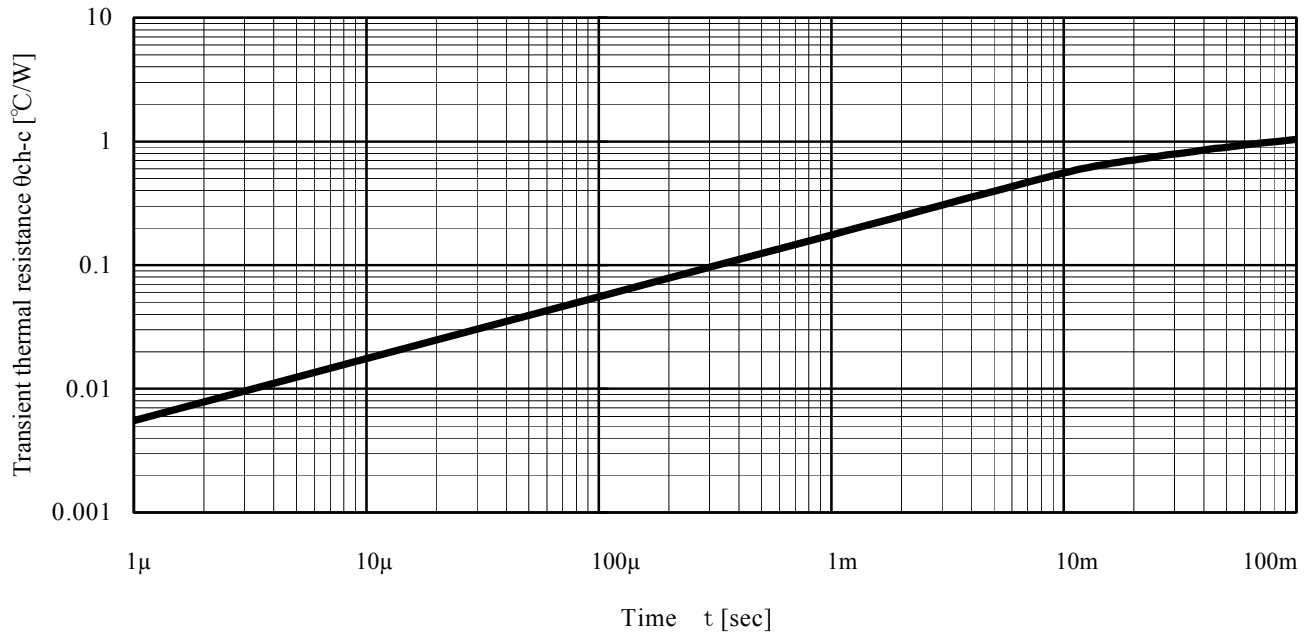

Block Diagram

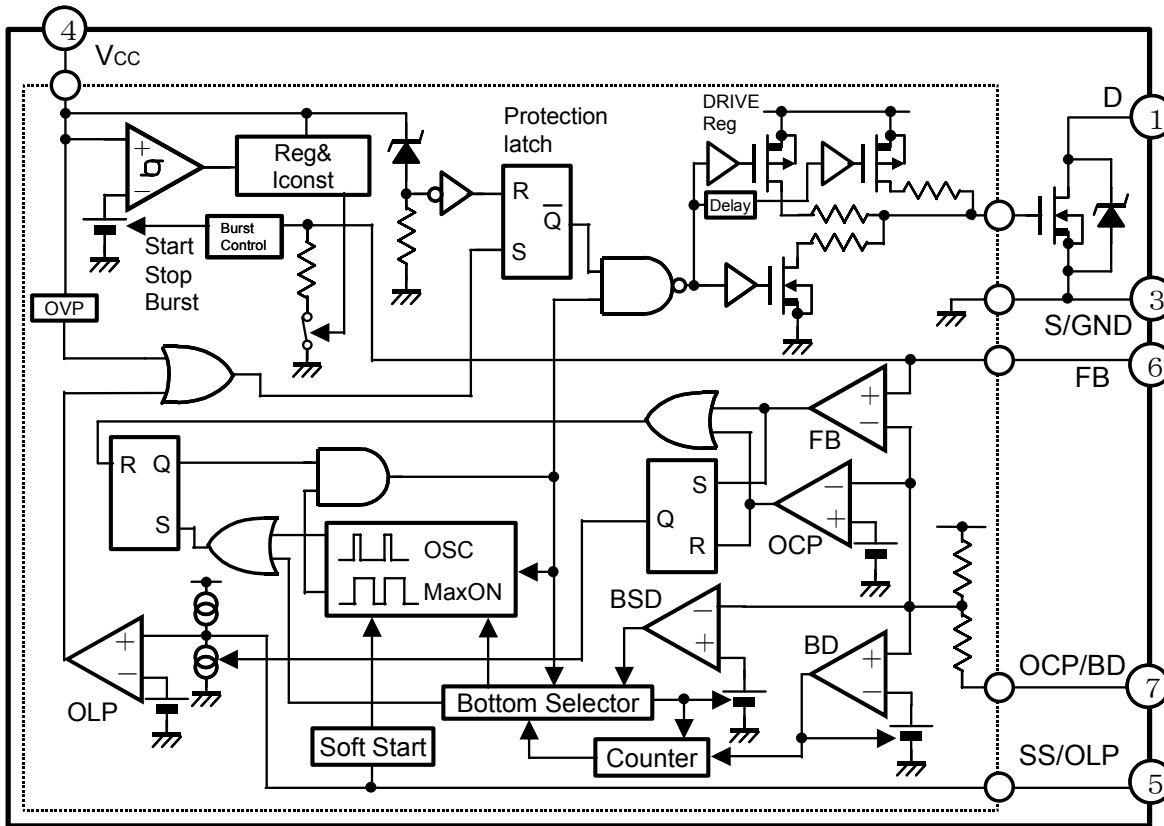

Pin Designation

| Pin No. | Symbols | Descriptions | Functions |
|---------|---------|---|---|
| 1 | D | Drain pin | MOSFET drain |
| 3 | S/GND | Source /Ground pin | MOSFET Source / Ground |
| 4 | Vcc | Power supply pin | Input of power supply for control circuit |
| 5 | SS/OLP | Delay at Overload /Soft Start set up Pin | Overload Protection and Soft Start Operation Time set up |
| 6 | FB | Feedback pin | Constant Voltage Control Signal Input, Burst(intermittent) mode Oscillation Control |
| 7 | OCP/BD | Overcurrent Protection / Bottom Detection Pin | Overcurrent Detection Signal Input /Bottom Detection Signal Input |

Pin Assignments

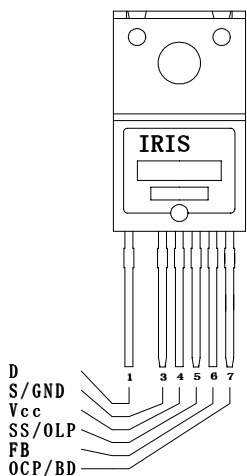

IRIS-W6754

Case Outline

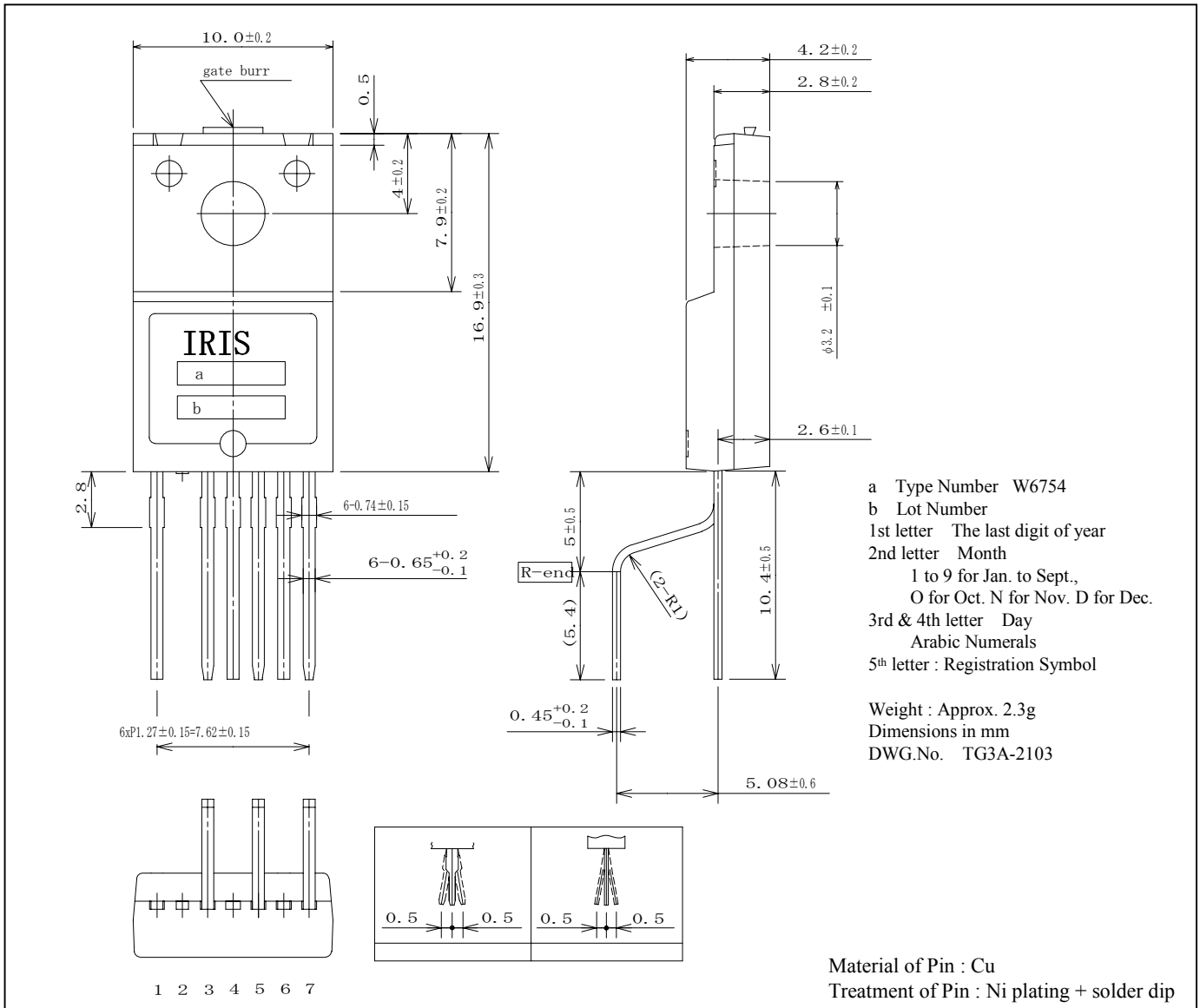

a Type Number W6754
 b Lot Number
 1st letter The last digit of year
 2nd letter Month
 1 to 9 for Jan. to Sept.,
 O for Oct. N for Nov. D for Dec.
 3rd & 4th letter Day
 Arabic Numerals
 5th letter : Registration Symbol

Weight : Approx. 2.3g
 Dimensions in mm
 DWG.No. TG3A-2103

Data and specifications subject to change without notice.



IR WORLD HEADQUARTERS: 233 Kansas St., El Segundo, California 90245, USA Tel: (310) 252-7105

TAC FAX: (310) 252-7903

Visit us at www.irf.com for sales contact information.