



921 MHz-960 MHz SiFET RF Integrated Power Amplifier

The MHVIC910HNR2 integrated circuit is designed for GSM base stations, uses Freescale's newest High Voltage (26 Volts) LDMOS IC technology, and contains a three-stage amplifier. Target applications include macrocell (driver function) and microcell base stations (final stage). The device is in a PFP-16 Power Flat Pack package which gives excellent thermal performances through a solderable backside contact.

- Typical GSM Performance: $V_{DD} = 26$ Volts, $I_{DQ} = 150$ mA, $P_{out} = 10$ Watts, Full Frequency Band (921 -960 MHz)
 Power Gain — 39 dB (Typ)
 Power Added Efficiency — 48% (Typ)
- Capable of Handling 10:1 VSWR, @ 26 Vdc, 945 MHz, 10 Watts CW Output Power
- Stable into a 10:1 VSWR. All Spurs Below -60 dBc @ 0 to 40 dBm CW P_{out} .

Features

- On-Chip Matching (50 Ohm Input, DC Blocked, >5 Ohm Output)
- Integrated ESD Protection
- Usable Frequency Range — 921 to 960 MHz
- RoHS Compliant
- In Tape and Reel. R2 Suffix = 1,500 Units per 16 mm, 13 inch Reel.

MHVIC910HNR2

**960 MHz, 10 W, 26 V
 GSM CELLULAR
 RF LDMOS INTEGRATED CIRCUIT**

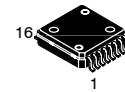

**CASE 978-03
 PFP-16**

Table 1. Maximum Ratings

Rating	Symbol	Value	Unit
Drain Supply Voltage	V_{DD}	28	Vdc
Gate Supply Voltage	V_{GS}	6	Vdc
RF Input Power	P_{in}	5	dBm
Case Operating Temperature	T_C	- 30 to + 85	°C
Storage Temperature Range	T_{stg}	- 65 to + 150	°C
Operating Channel Temperature	T_{ch}	150	°C

Table 2. Thermal Characteristics

Characteristic	Symbol	Value	Unit
Thermal Resistance, Junction to Case	$R_{\theta JC}$	2.9	°C/W

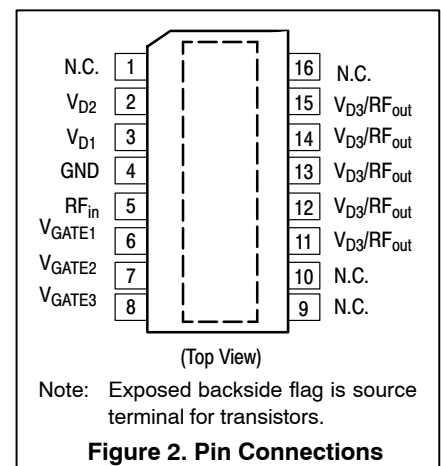
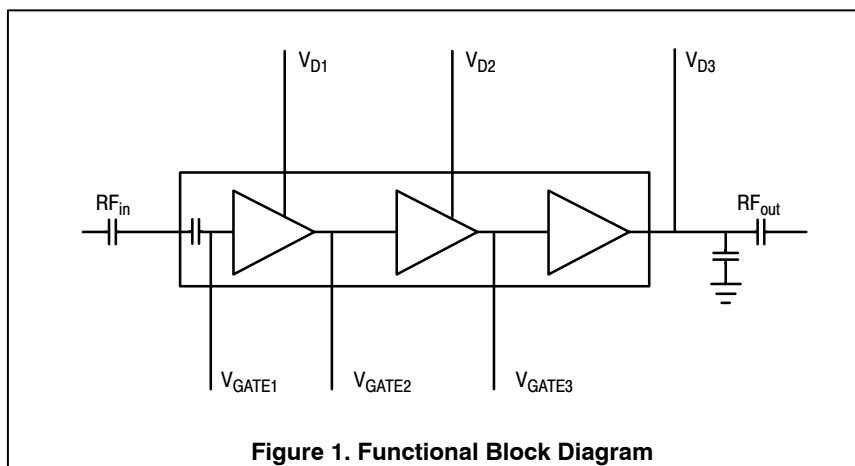

Table 3. ESD Protection Characteristics

Test Conditions	Class
Human Body Model	0 (Minimum)
Machine Model	M2 (Minimum)

Table 4. Moisture Sensitivity Level

Test Methodology	Rating	Package Peak Temperature	Unit
Per JESD 22-A113, IPC/JEDEC J-STD-020	3	260	°C

Table 5. Recommended Operating Ranges

Parameter	Symbol	Value	Unit
Drain Supply Voltage	V _{DD}	26	Vdc
3rd Stage Quiescent Current	I _{DQ3}	150	mA
2nd Stage Quiescent Current	I _{DQ2}	50	mA
1st Stage Quiescent Current	I _{DQ1}	25	mA

Table 6. Electrical Characteristics (T_A = 25°C matched to a 50 Ω system, unless otherwise noted)

V_{DD} = 26 V, V_{GS} set for I_{DQ3} = 150 mA, frequency range 921 - 960 MHz

Characteristic	Symbol	Min	Typ	Max	Unit
Frequency Range	f _{RF}	921	—	960	MHz
Output Power @ 1 dB Compression Point	P @ 1dB	39	40	—	dBm
Power Gain @ P1dB	G @ 1dB	38	39	—	dB
Power Added Efficiency @ 1 dB Compression Point	PAE @ 1dB	43	48	—	%
Input Return Loss @ P1dB	IRL @ 1dB	—	-15	-10	dB
Gain Flatness @ 40 dBm	G _F	—	.5	—	dB
Variation (T _C = -30 to +85°C @ 40 dBm)	G _V	—	5	—	dB

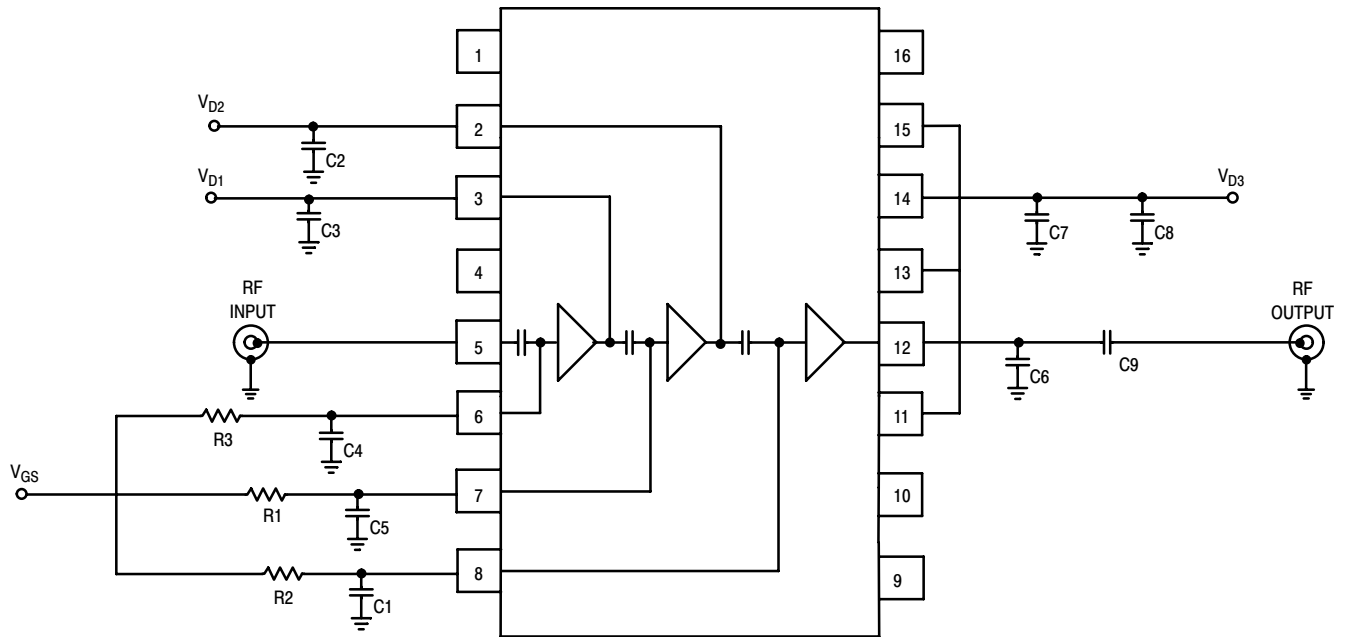

C1, C2, C3, C4, C5, C8	1 μ F Surface Mount Chip Capacitors	J1, J2	Header (Break-away), HDR2X10STIMCSAFU
C6	4.7 pF AVX Chip Capacitor, ACCU-P (08051J4R7BBT)	J3, J4	SMA Connector 2052-1618-02 (Threaded)
C7	47 pF AVX Chip Capacitor, ACCU-P (08055K470JBTTTR)	R1, R2, R3	100 Ω Chip Resistors (0402)
C9	33 pF AVX Chip Capacitor, ACCU-P (08053J330JBT)	PCB	Rogers 04350, 20 mils

Figure 3. 921-960 MHz Demo Board Schematic

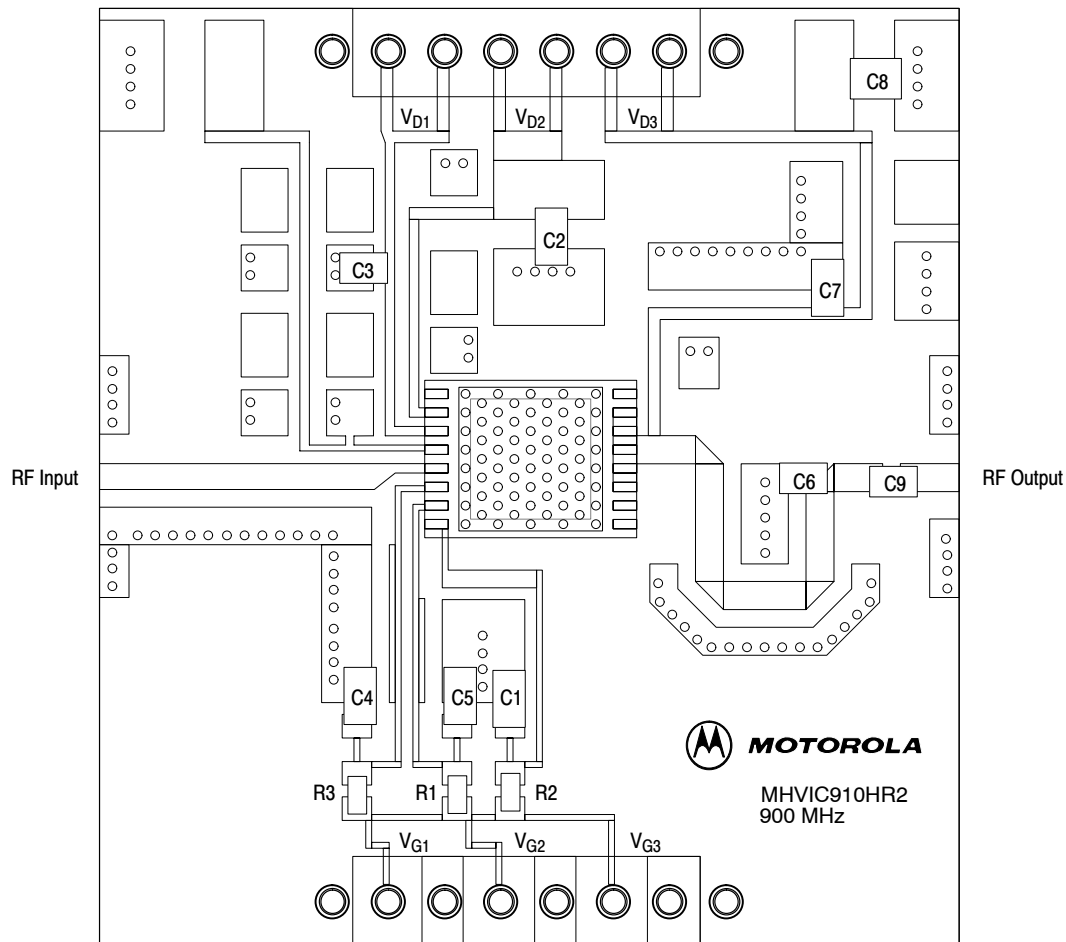

Freescale has begun the transition of marking Printed Circuit Boards (PCBs) with the Freescale Semiconductor signature/logo. PCBs may have either Motorola or Freescale markings during the transition period. These changes will have no impact on form, fit or function of the current product.

Figure 4. 921 -960 MHz Demo Board Component Layout

TYPICAL CHARACTERISTICS

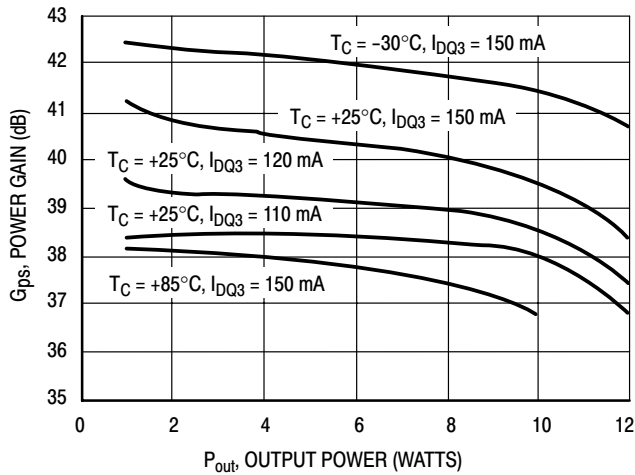

Figure 5. Power Gain versus Output Power

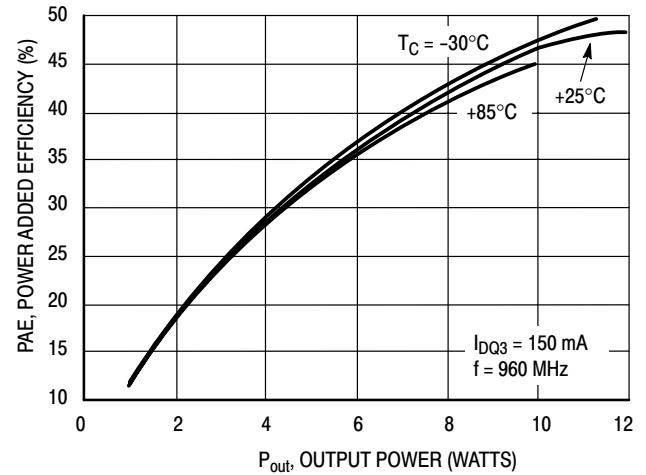

Figure 6. Power Added Efficiency versus Output Power

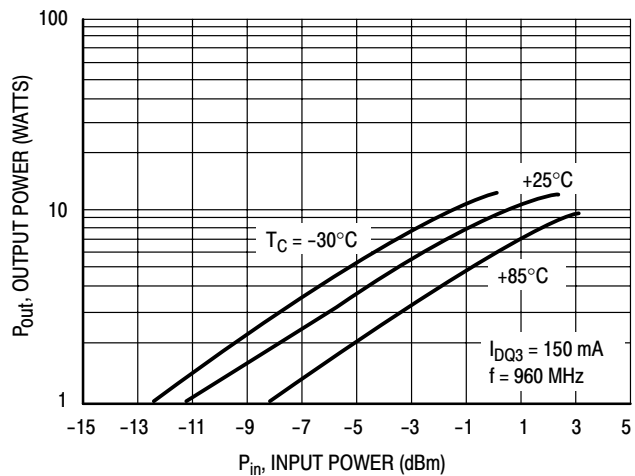
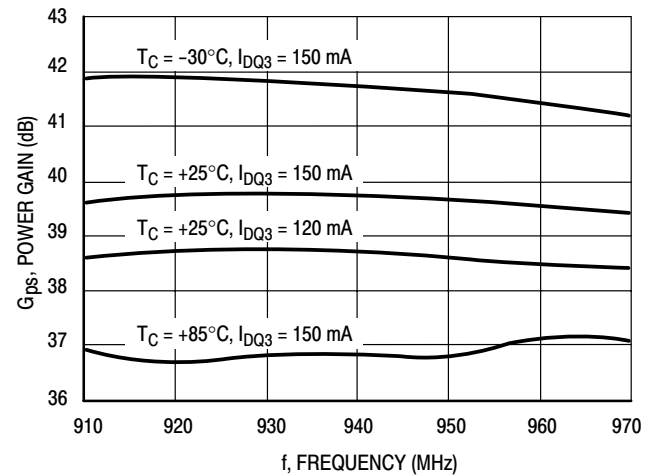
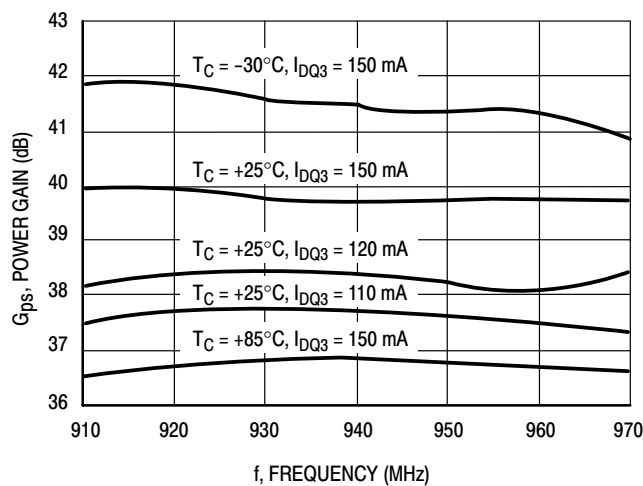

Figure 7. Output Power versus Input Power



**Figure 8. Power Gain versus Frequency
P_{out} = 10 W**



**Figure 9. Power Gain versus Frequency
P_{out} = P1dB**

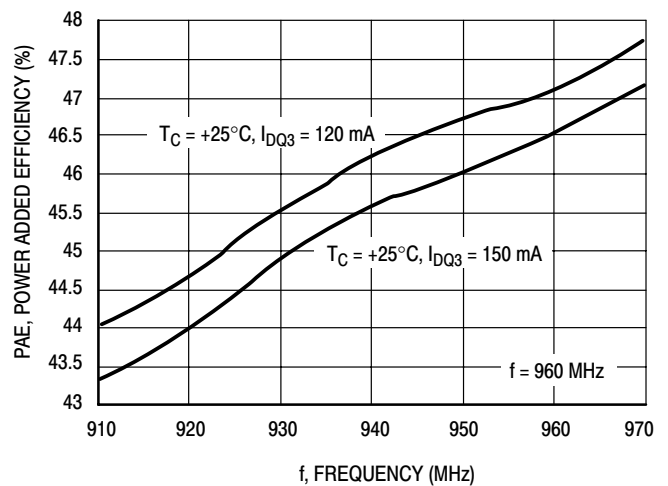

**Figure 10. Power Added Efficiency versus Frequency
P_{out} = 10 W**

TYPICAL CHARACTERISTICS

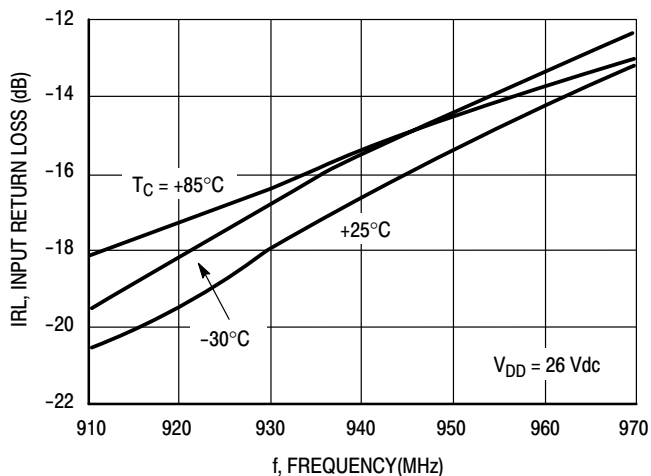

Figure 11. Input Return Loss versus Frequency
 $P_{out} = 10\text{ W}$

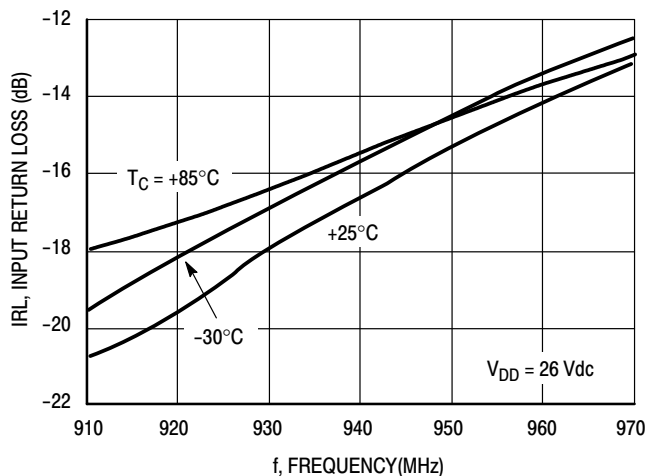

Figure 12. Input Return Loss versus Frequency
 $P_{out} = P_{1dB}$

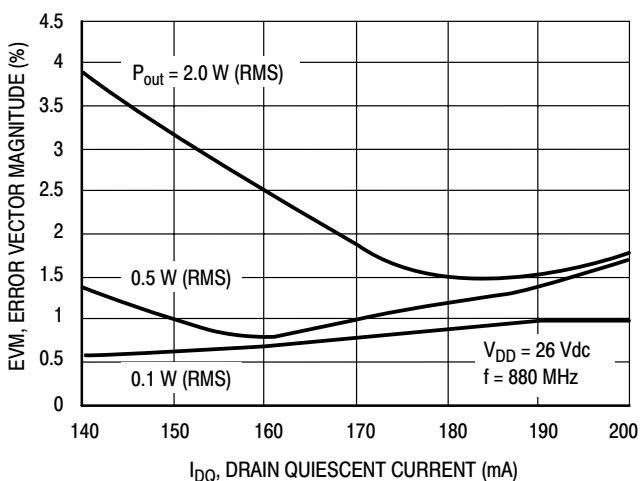

Figure 13. Error Vector Magnitude versus I_{DQ} Total

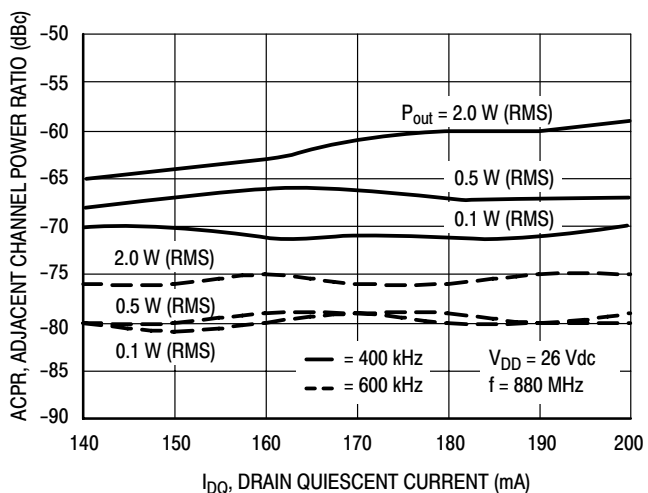

Figure 14. Adjacent Channel Power Ratio versus I_{DQ} Total

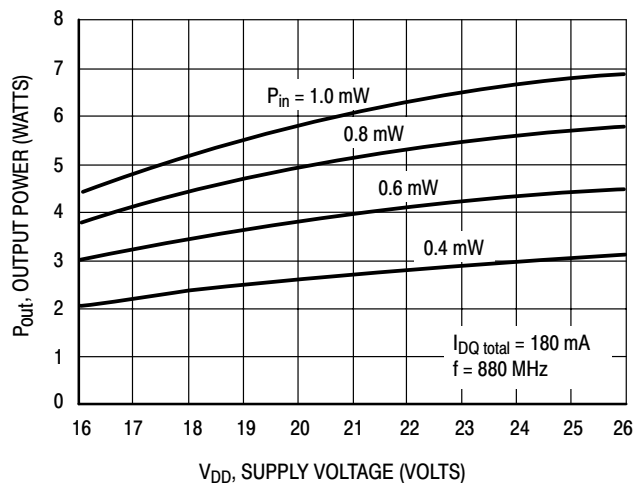

Figure 15. Output Power versus Supply Voltage

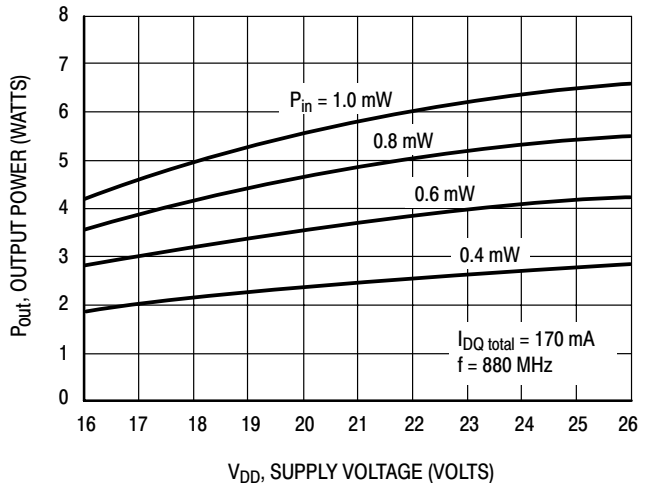

Figure 16. Output Power versus Supply Voltage

TYPICAL CHARACTERISTICS

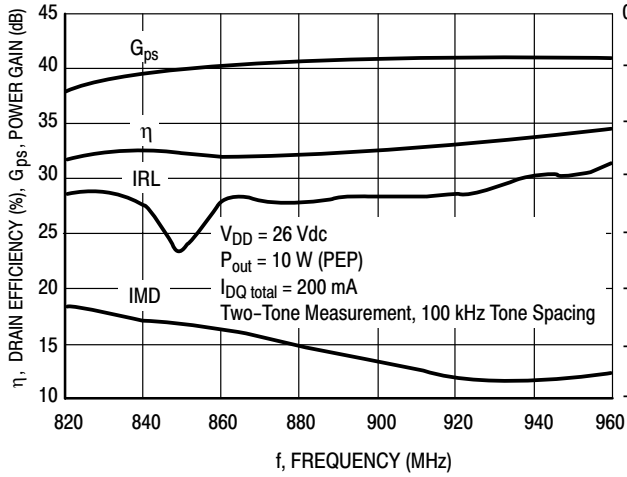

Figure 17. Two-Tone Broadband Performance

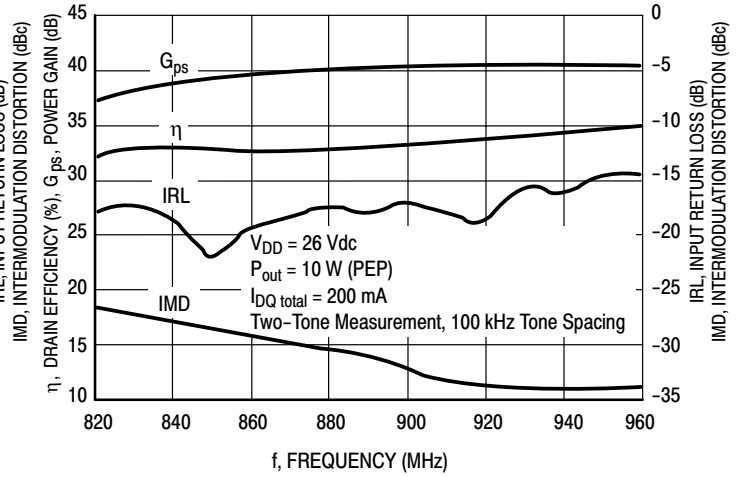

Figure 18. Two-Tone Broadband Performance

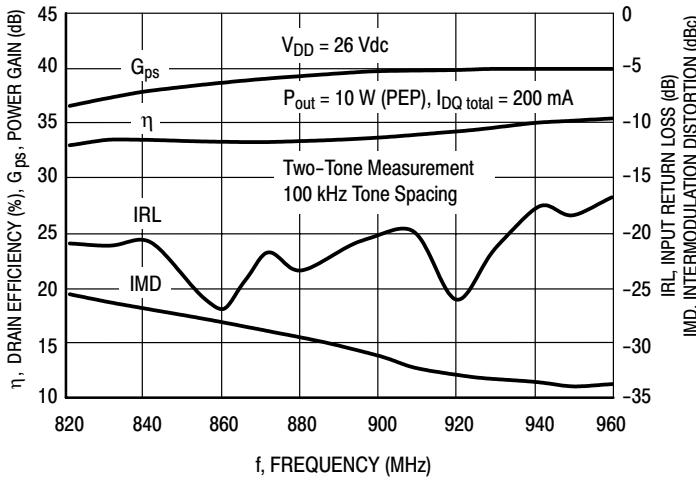

Figure 19. Two-Tone Broadband Performance

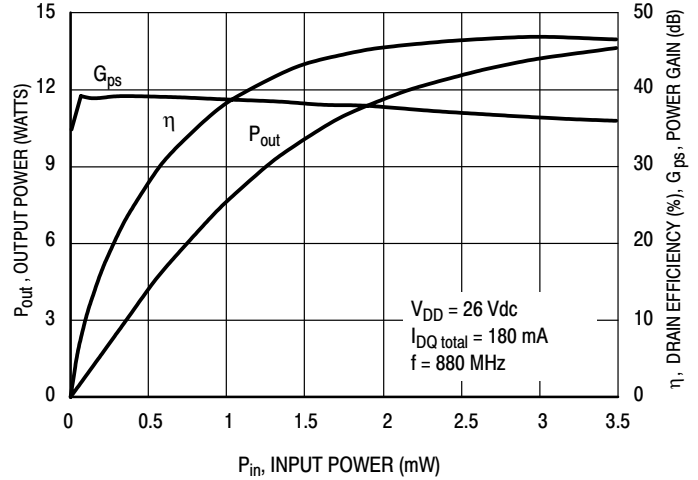

Figure 20. CW Performance @ 880 MHz

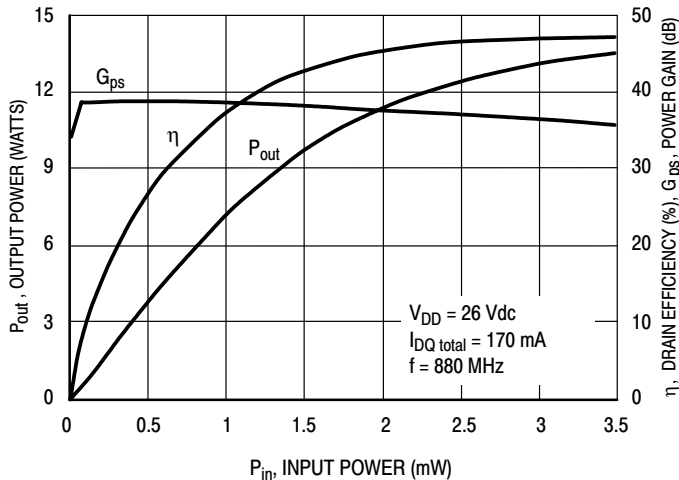

Figure 21. CW Performance @ 880 MHz

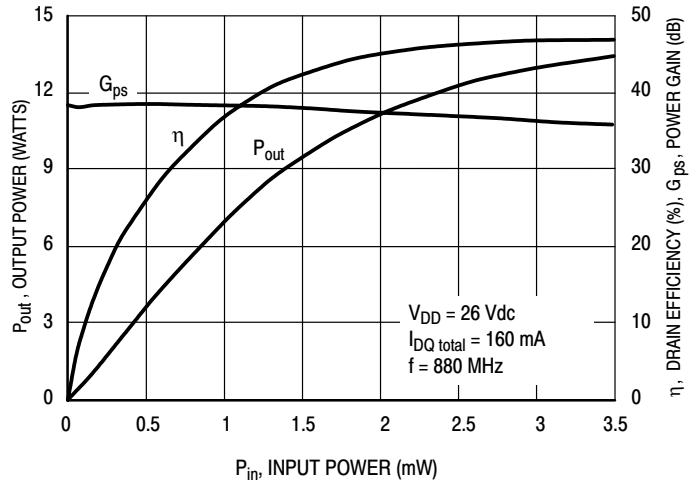

Figure 22. CW Performance @ 880 MHz

TYPICAL CHARACTERISTICS

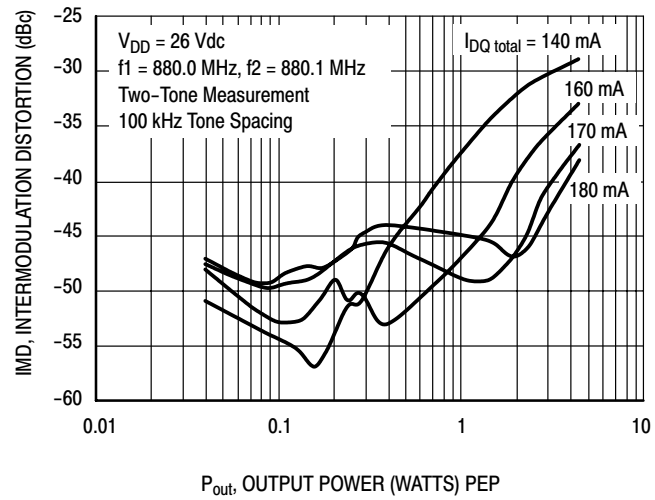

Figure 23. Intermodulation Distortion versus Output Power

$V_{DD} = 26\text{ V}$, $I_{DQ} = 225\text{ mA}$, $P_{out} = 40\text{ dBm}$

f MHz	Z_{load} Ω
900	$7.81 + j4.61$
920	$7.27 + j4.90$
940	$6.77 + j5.23$
960	$6.31 + j5.59$
980	$5.90 + j5.96$
1000	$5.53 + j6.36$

Z_{load} = Test circuit impedance as measured from drain to ground.

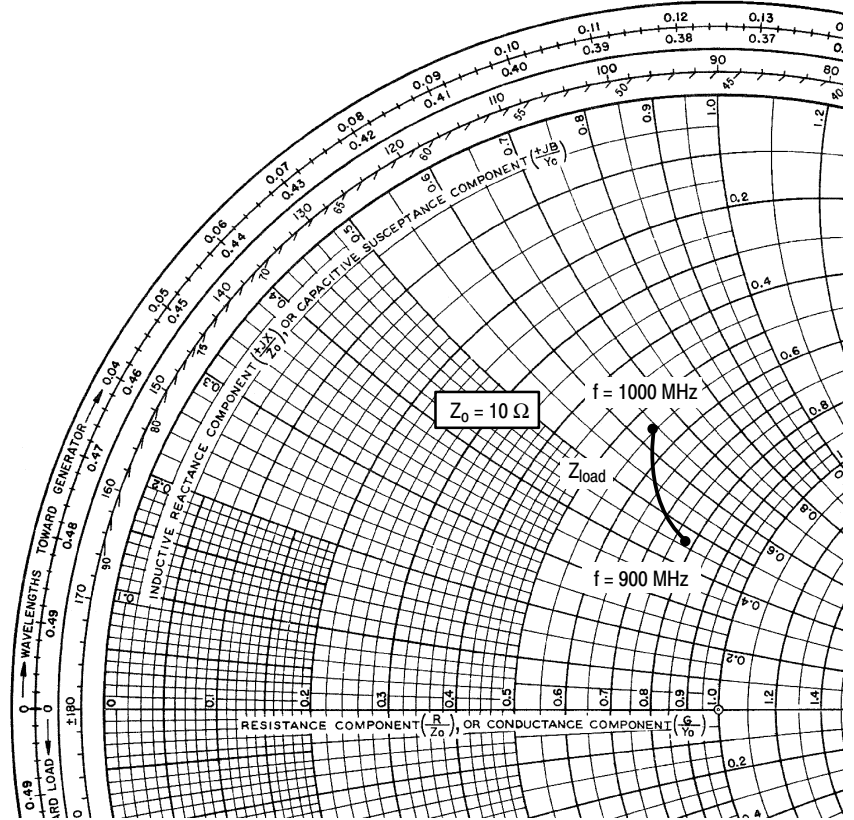
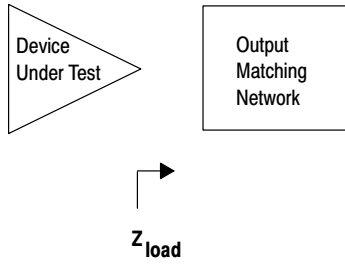
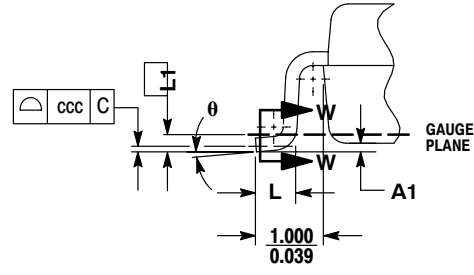
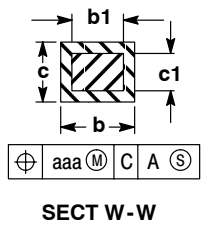
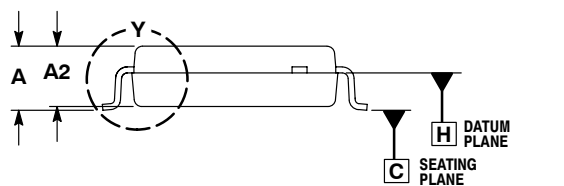
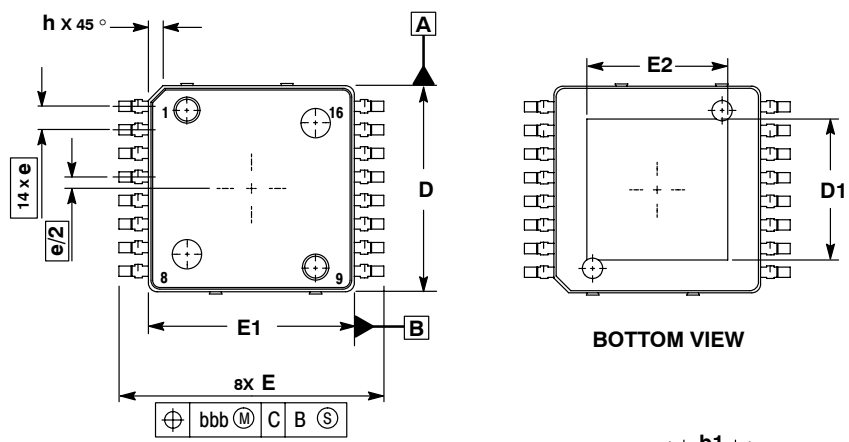

Figure 24. Series Equivalent Load Impedance



NOTES

PACKAGE DIMENSIONS



- NOTES:
1. CONTROLLING DIMENSION: MILLIMETER.
 2. DIMENSIONS AND TOLERANCES PER ASME Y14.5M, 1994.
 3. DATUM PLANE -H- IS LOCATED AT BOTTOM OF LEAD AND IS COINCIDENT WITH THE LEAD WHERE THE LEAD EXITS THE PLASTIC BODY AT THE BOTTOM OF THE PARTING LINE.
 4. DIMENSIONS D AND E1 DO NOT INCLUDE MOLD PROTRUSION. ALLOWABLE PROTRUSION IS 0.250 PER SIDE. DIMENSIONS D AND E1 DO INCLUDE MOLD MISMATCH AND ARE DETERMINED AT DATUM PLANE -H-.
 5. DIMENSION b DOES NOT INCLUDE DAMBAR PROTRUSION. ALLOWABLE DAMBAR PROTRUSION IS 0.127 TOTAL IN EXCESS OF THE b DIMENSION AT MAXIMUM MATERIAL CONDITION.
 6. DATUMS -A- AND -B- TO BE DETERMINED AT DATUM PLANE -H-.

DIM	MILLIMETERS	
	MIN	MAX
A	2.000	2.300
A1	0.025	0.100
A2	1.950	2.100
D	6.950	7.100
D1	4.372	5.180
E	8.850	9.150
E1	6.950	7.100
E2	4.372	5.180
L	0.466	0.720
L1	0.250 BSC	
b	0.300	0.432
b1	0.300	0.375
c	0.180	0.279
c1	0.180	0.230
e	0.800 BSC	
h	---	0.600
θ	0°	7°
aaa	0.200	
bbb	0.200	
ccc	0.100	

CASE 978-03
ISSUE C
PFP-16

How to Reach Us:

Home Page:

www.freescale.com

E-mail:

support@freescale.com

USA/Europe or Locations Not Listed:

Freescale Semiconductor
Technical Information Center, CH370
1300 N. Alma School Road
Chandler, Arizona 85224
+1-800-521-6274 or +1-480-768-2130
support@freescale.com

Europe, Middle East, and Africa:

Freescale Halbleiter Deutschland GmbH
Technical Information Center
Schatzbogen 7
81829 Muenchen, Germany
+44 1296 380 456 (English)
+46 8 52200080 (English)
+49 89 92103 559 (German)
+33 1 69 35 48 48 (French)
support@freescale.com

Japan:

Freescale Semiconductor Japan Ltd.
Headquarters
ARCO Tower 15F
1-8-1, Shimo-Meguro, Meguro-ku,
Tokyo 153-0064
Japan
0120 191014 or +81 3 5437 9125
support.japan@freescale.com

Asia/Pacific:

Freescale Semiconductor Hong Kong Ltd.
Technical Information Center
2 Dai King Street
Tai Po Industrial Estate
Tai Po, N.T., Hong Kong
+800 2666 8080
support.asia@freescale.com

For Literature Requests Only:

Freescale Semiconductor Literature Distribution Center
P.O. Box 5405
Denver, Colorado 80217
1-800-441-2447 or 303-675-2140
Fax: 303-675-2150
LDCForFreescaleSemiconductor@hibbertgroup.com

RoHS-compliant and/or Pb-free versions of Freescale products have the functionality and electrical characteristics of their non-RoHS-compliant and/or non-Pb-free counterparts. For further information, see <http://www.freescale.com> or contact your Freescale sales representative.

For information on Freescale's Environmental Products program, go to <http://www.freescale.com/epp>.

Information in this document is provided solely to enable system and software implementers to use Freescale Semiconductor products. There are no express or implied copyright licenses granted hereunder to design or fabricate any integrated circuits or integrated circuits based on the information in this document.

Freescale Semiconductor reserves the right to make changes without further notice to any products herein. Freescale Semiconductor makes no warranty, representation or guarantee regarding the suitability of its products for any particular purpose, nor does Freescale Semiconductor assume any liability arising out of the application or use of any product or circuit, and specifically disclaims any and all liability, including without limitation consequential or incidental damages. "Typical" parameters that may be provided in Freescale Semiconductor data sheets and/or specifications can and do vary in different applications and actual performance may vary over time. All operating parameters, including "Typicals", must be validated for each customer application by customer's technical experts. Freescale Semiconductor does not convey any license under its patent rights nor the rights of others. Freescale Semiconductor products are not designed, intended, or authorized for use as components in systems intended for surgical implant into the body, or other applications intended to support or sustain life, or for any other application in which the failure of the Freescale Semiconductor product could create a situation where personal injury or death may occur. Should Buyer purchase or use Freescale Semiconductor products for any such unintended or unauthorized application, Buyer shall indemnify and hold Freescale Semiconductor and its officers, employees, subsidiaries, affiliates, and distributors harmless against all claims, costs, damages, and expenses, and reasonable attorney fees arising out of, directly or indirectly, any claim of personal injury or death associated with such unintended or unauthorized use, even if such claim alleges that Freescale Semiconductor was negligent regarding the design or manufacture of the part.

Freescale™ and the Freescale logo are trademarks of Freescale Semiconductor, Inc. All other product or service names are the property of their respective owners.
© Freescale Semiconductor, Inc. 2006. All rights reserved.

RoHS-compliant and/or Pb-free versions of Freescale products have the functionality and electrical characteristics of their non-RoHS-compliant and/or non-Pb-free counterparts. For further information, see <http://www.freescale.com> or contact your Freescale sales representative.

For information on Freescale's Environmental Products program, go to <http://www.freescale.com/epp>.

