



# Dual N-Channel 20-V (D-S) MOSFET

## TrenchFET<sup>®</sup> MOSFETs 1.8-V Rated



### ESD Protected 2000 V

PRODUCT SUMMARY		
V <sub>DS</sub> (V)	r <sub>DS(on)</sub> (Ω)	I <sub>D</sub> (mA)
20	0.70 @ V <sub>GS</sub> = 4.5 V	600
	0.85 @ V <sub>GS</sub> = 2.5 V	500
	1.25 @ V <sub>GS</sub> = 1.8 V	350

### FEATURES

- Very Small Footprint
- High-Side Switching
- Low On-Resistance: 0.7 Ω
- Low Threshold: 0.8 V (typ)
- Fast Switching Speed: 10 ns
- 1.8-V Operation
- Gate-Source ESD Protection

### BENEFITS

- Ease in Driving Switches
- Low Offset (Error) Voltage
- Low-Voltage Operation
- High-Speed Circuits
- Low Battery Voltage Operation

### APPLICATIONS

- Drivers: Relays, Solenoids, Lamps, Hammers, Displays, Memories
- Battery Operated Systems
- Power Supply Converter Circuits
- Load/Power Switching Cell Phones, Pagers

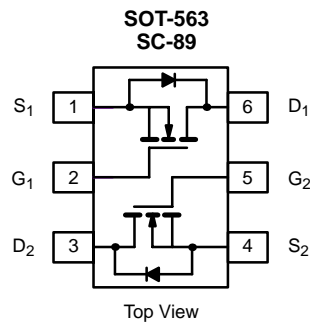

Marking Code: C

ABSOLUTE MAXIMUM RATINGS (T <sub>A</sub> = 25 °C UNLESS OTHERWISE NOTED)				
Parameter	Symbol	5 secs	Steady State	Unit
Drain-Source Voltage	V <sub>DS</sub>	20		V
Gate-Source Voltage	V <sub>GS</sub>	±6		
Continuous Drain Current (T <sub>J</sub> = 150 °C) <sup>a</sup>	T <sub>A</sub> = 25 °C	515	485	mA
	T <sub>A</sub> = 85 °C	370	350	
Pulsed Drain Current <sup>b</sup>	I <sub>DM</sub>	650		
Continuous Source Current (diode conduction)	I <sub>S</sub>	450	380	
Maximum Power Dissipation <sup>a</sup>	T <sub>A</sub> = 25 °C	280	250	mW
	T <sub>A</sub> = 85 °C	145	130	
Operating Junction and Storage Temperature Range	T <sub>J</sub> , T <sub>stg</sub>	-55 to 150		°C
Gate-Source ESD Rating (HBM, Method 3015)	ESD	2000		V

Notes

- a. Surface Mounted on FR4 Board.
- b. Pulse width limited by maximum junction temperature.

### SPECIFICATIONS (T<sub>J</sub> = 25 °C UNLESS OTHERWISE NOTED)

Parameter	Symbol	Test Condition	Min	Typ	Max	Unit
<b>Static</b>						
Gate Threshold Voltage	V <sub>GS(th)</sub>	V <sub>DS</sub> = V <sub>GS</sub> , I <sub>D</sub> = 250 μA	0.45			V
Gate-Body Leakage	I <sub>GSS</sub>	V <sub>DS</sub> = 0 V, V <sub>GS</sub> = ±4.5 V		±0.5	±1.0	μA
Zero Gate Voltage Drain Current	I <sub>DSS</sub>	V <sub>DS</sub> = 16 V, V <sub>GS</sub> = 0 V		0.3	100	nA
		V <sub>DS</sub> = 16 V, V <sub>GS</sub> = 0 V, T <sub>J</sub> = 85 °C			5	μA
On-State Drain Current <sup>a</sup>	I <sub>D(on)</sub>	V <sub>DS</sub> = 5 V, V <sub>GS</sub> = 4.5 V	700			mA
Drain-Source On-State Resistance <sup>a</sup>	r <sub>DS(on)</sub>	V <sub>GS</sub> = 4.5 V, I <sub>D</sub> = 600 mA		0.41	0.70	Ω
		V <sub>GS</sub> = 2.5 V, I <sub>D</sub> = 500 mA		0.53	0.85	
		V <sub>GS</sub> = 1.8 V, I <sub>D</sub> = 350 mA		0.70	1.25	
Forward Transconductance <sup>a</sup>	g <sub>fs</sub>	V <sub>DS</sub> = 10 V, I <sub>D</sub> = 400 mA		1.0		S
Diode Forward Voltage <sup>a</sup>	V <sub>SD</sub>	I <sub>S</sub> = 150 mA, V <sub>GS</sub> = 0 V		0.8	1.2	V
<b>Dynamic<sup>b</sup></b>						
Total Gate Charge	Q <sub>g</sub>	V <sub>DS</sub> = 10 V, V <sub>GS</sub> = 4.5 V, I <sub>D</sub> = 250 mA		750		pC
Gate-Source Charge	Q <sub>gs</sub>			75		
Gate-Drain Charge	Q <sub>gd</sub>			225		
Turn-On Time	t <sub>ON</sub>	V <sub>DD</sub> = 10 V, R <sub>L</sub> = 47 Ω I <sub>D</sub> ≅ 200 mA, V <sub>GEN</sub> = 4.5 V, R <sub>G</sub> = 10 Ω		10		ns
Turn-Off Time	t <sub>OFF</sub>			36		

#### Notes

- Pulse test; pulse width ≤ 300 μs, duty cycle ≤ 2%.
- Guaranteed by design, not subject to production testing.

### TYPICAL CHARACTERISTICS (T<sub>A</sub> = 25 °C UNLESS NOTED)

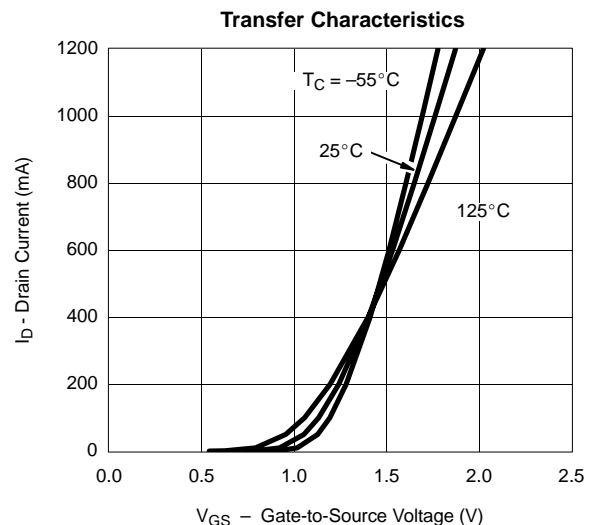
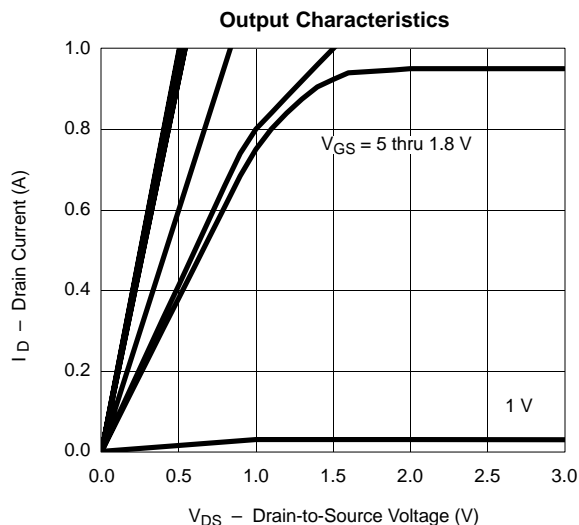



**TYPICAL CHARACTERISTICS (T<sub>A</sub> = 25°C UNLESS NOTED)**

**On-Resistance vs. Drain Current**

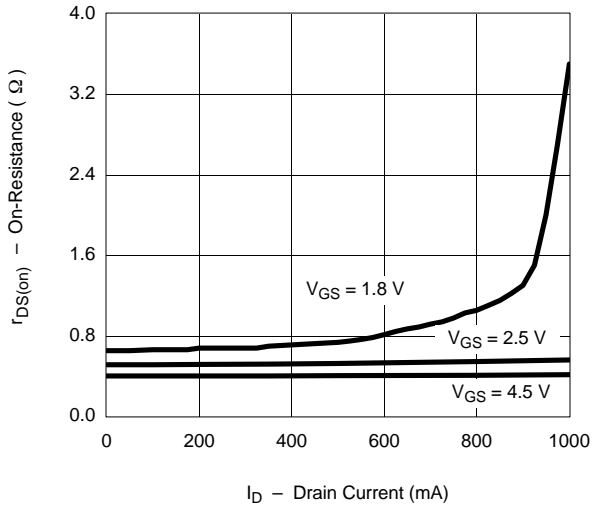

**Capacitance**

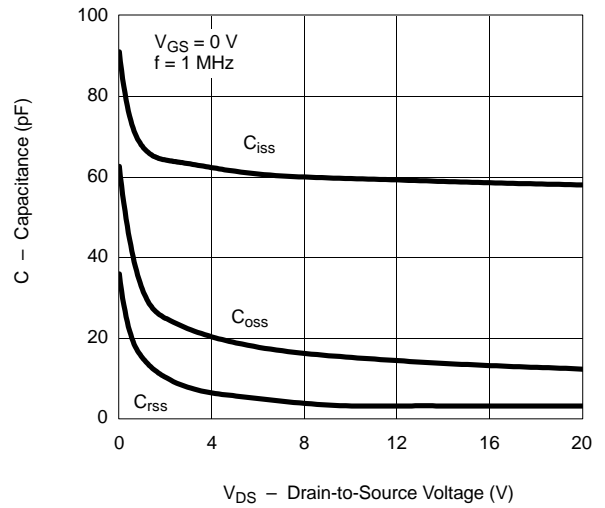

**Gate Charge**

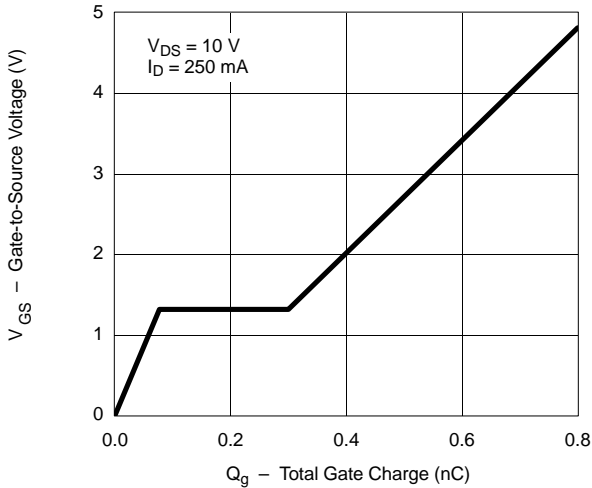

**On-Resistance vs. Junction Temperature**

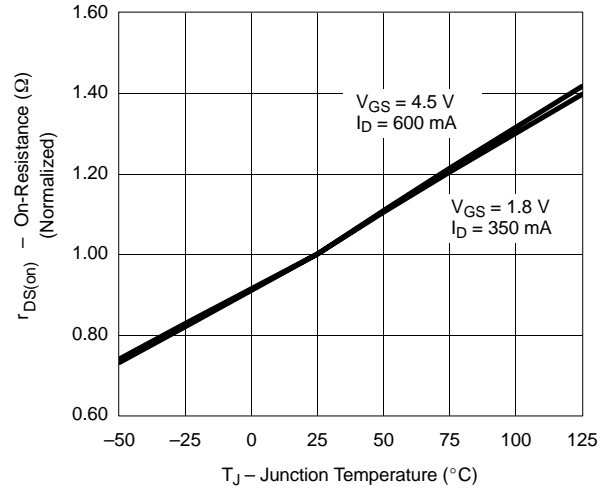

**Source-Drain Diode Forward Voltage**

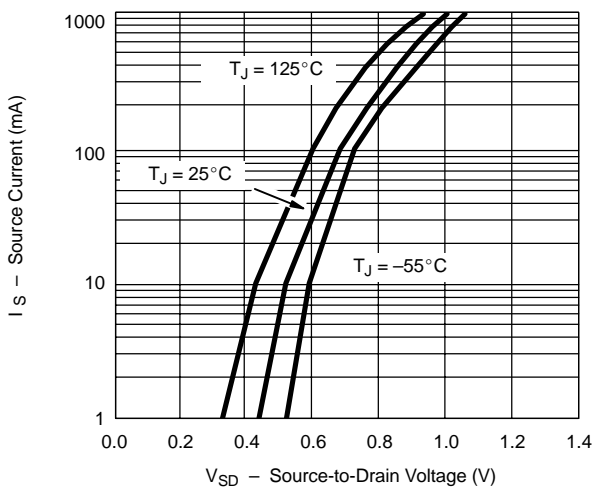

**On-Resistance vs. Gate-to-Source Voltage**

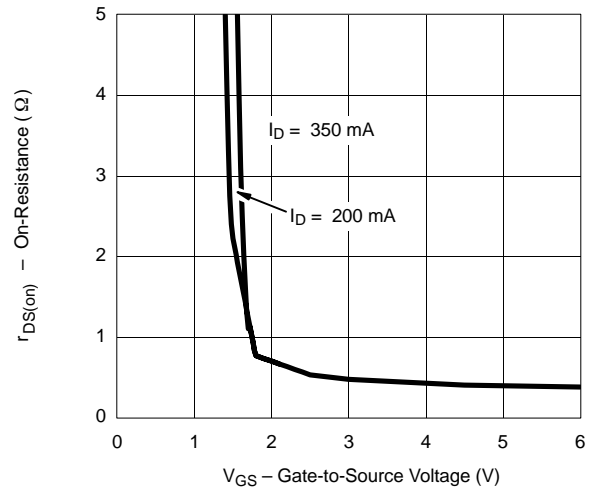

**TYPICAL CHARACTERISTICS (T<sub>A</sub> = 25°C UNLESS NOTED)**

