

V_{RSM}	V_{RRM} V_{DRM}	$(dv/dt)_{cr}$	I_{TRMS} (maximum values for continuous operation)	
			2300 A	2800 A
V	V	V/ μ s	I_{TAV} (sin. 180; $T_{case} = \dots$; DSC)	
			1465 A (58 °C)	1780 A (55 °C)
500	400	500	SKT 1000/04 D	SKT 1200/04 D
900	800	500	SKT 1000/08 D	–
1300	1200	1000	SKT 1000/12 E	SKT 1200/12 E
1500	1400	1000	SKT 1000/14 E	SKT 1200/14 E
1700	1600	1000	SKT 1000/16 E	SKT 1200/16 E
1900	1800	1000	SKT 1000/18 E	SKT 1200/18 E
2300	2200	1000	SKT 1000/22 E L2	–
2700	2600	1000	SKT 1000/26 E L2	–
2900	2800	1000	SKT 1000/28 E L2	–

Thyristors

SKT 1000 SKT 1200



Symbol	Conditions	SKT 1000	SKT 1200	Units
I_{TAV}	sin. 180; $T_{case} = 85$ °C; DSC	1000	1200	A
I_{TSM}	$T_{vj} = 25$ °C; 10 ms	19 000	30 000	A
	$T_{vj} = 125$ °C; 10 ms	16 500	25 500	A
i^2t	$T_{vj} = 25$ °C; 8,3 ... 10 ms	1 800	4 500	kA ² s
	$T_{vj} = 125$ °C; 8,3 ... 10 ms	1 360	3 250	kA ² s
t_{gd}	$T_{vj} = 25$ °C $I_G = 1$ A $di_G/dt = 1$ A/ μ s	typ. 1		μ s
t_{gr}	$V_D = 0,67 \cdot V_{DRM}$	typ. 2		μ s
$(di/dt)_{cr}$	f = 50 ... 60 Hz	125		A/ μ s
I_H	$T_{vj} = 25$ °C; typ./max.	250 / 500		mA
I_L	$T_{vj} = 25$ °C; $R_G = 33$ Ω ; typ./max.	0,5 / 2		A
t_q	$T_{vj} = 125$ °C; typ.	100 ... 250		μ s
V_T	$T_{vj} = 25$ °C; $I_T = 3600$ A; max.	2,0	1,65	V
$V_{T(TO)}$	$T_{vj} = 125$ °C	1,14	0,95	V
r_T	$T_{vj} = 125$ °C	0,243	0,18	m Ω
$I_{DD}; I_{RD}$	$T_{vj} = 125$ °C; $V_{RD} = V_{RRM}$ $V_{DD} = V_{DRM}$	100		mA
V_{GT}	$T_{vj} = 25$ °C	5		V
I_{GT}	$T_{vj} = 25$ °C	250		mA
V_{GD}	$T_{vj} = 125$ °C	0,25		V
I_{GD}	$T_{vj} = 125$ °C	10		mA
R_{thjc}	cont.;	0,021		°C/W
	sin. 180; DSC/SSC	0,0225 / 0,054		°C/W
	rec. 120; DSC/SSC	0,027 / 0,060		°C/W
	DSC/SSC	0,005 / 0,010		°C/W
R_{thch}				°C/W
T_{vj}		– 40 ... + 125		°C
T_{stg}		– 40 ... + 130		°C
F	SI units	22 ... 25		kN
	US units	5000 ... 5600		lbs.
w		550		g
Case		B 14		

Features

- Hermetic metal cases with ceramic insulators
- Capsule packages for double sided cooling
- International standard cases
- Off-state and reverse voltages up to 2800 V
- Amplifying gate

Typical Applications

- DC motor control (e. g. for machine tools)
- Controlled rectifiers (e. g. for battery charging)
- AC controllers (e. g. for temperature control)

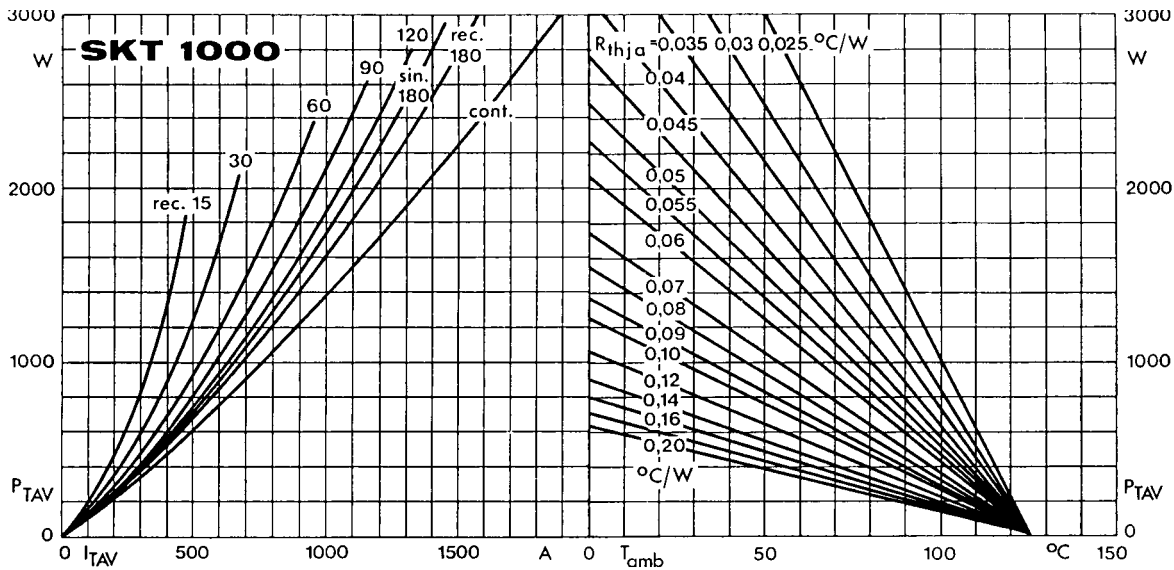

Fig. 1 a Power dissipation vs. on-state current and ambient temperature

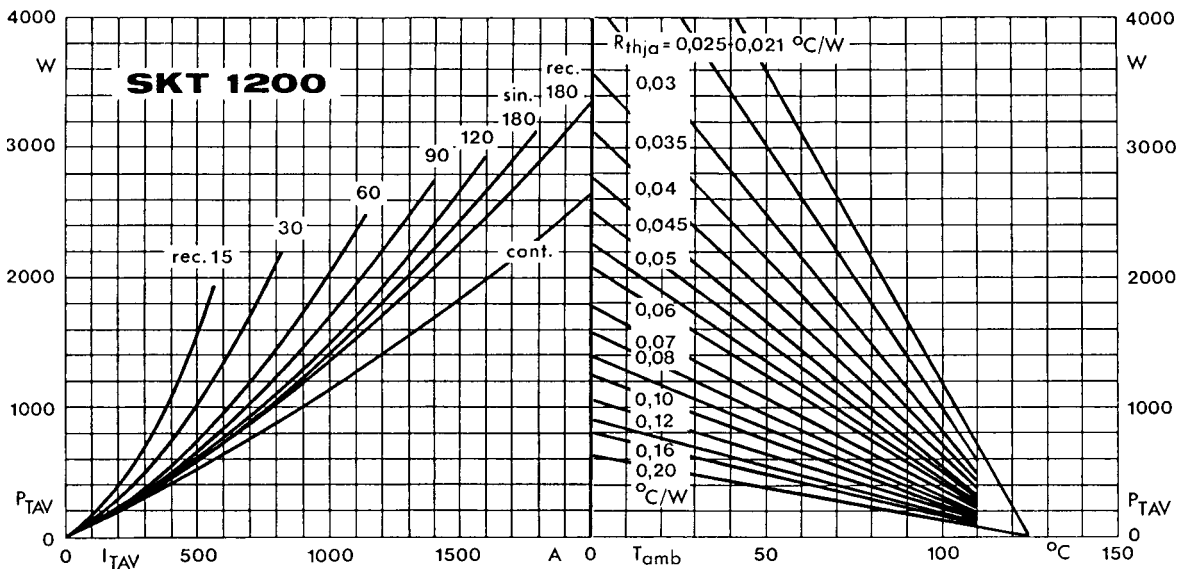

Fig. 1 b Power dissipation vs. on-state current and ambient temperature

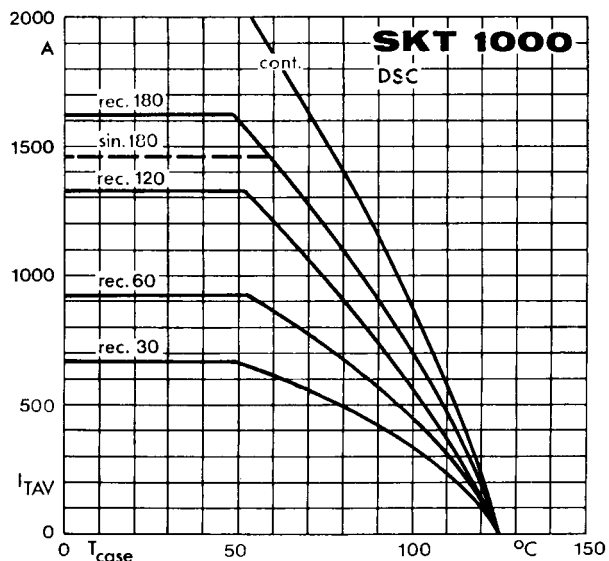

Fig. 2 a Rated on-state current vs. case temperature

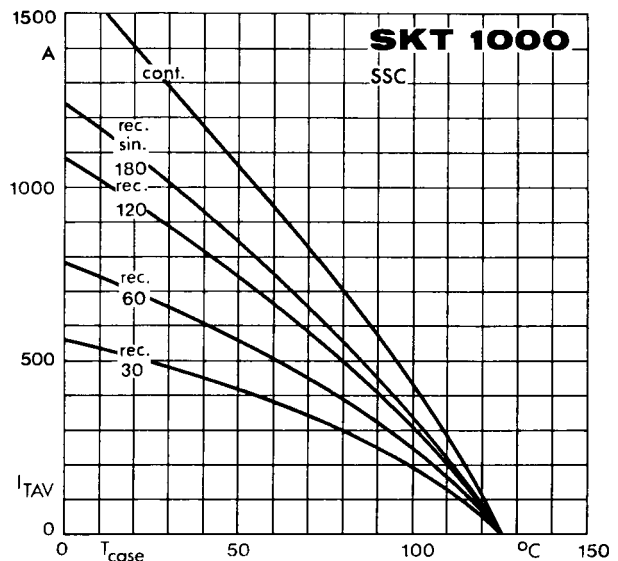

Fig. 2 b Rated on-state current vs. case temperature

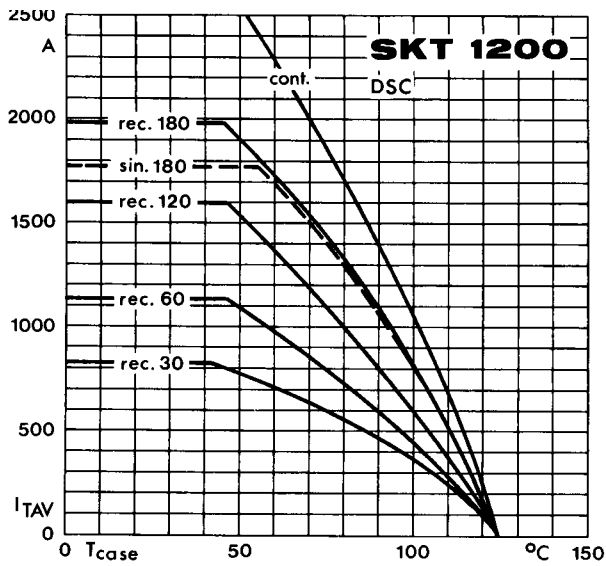

Fig. 2 c Rated on-state current vs. case temperature

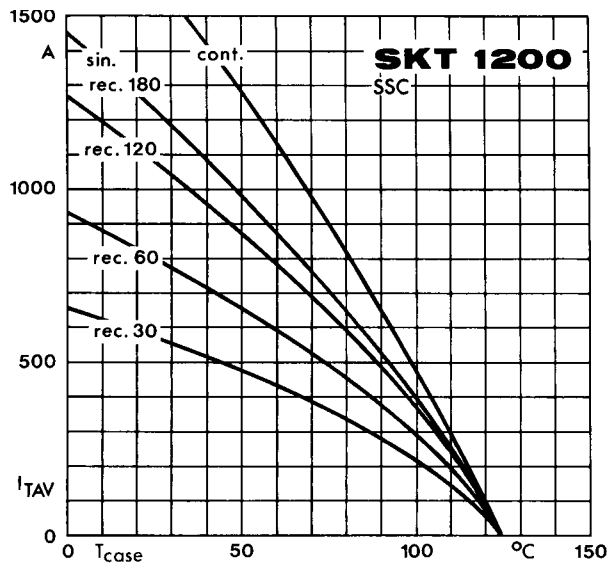

Fig. 2 d Rated on-state current vs. case temperature

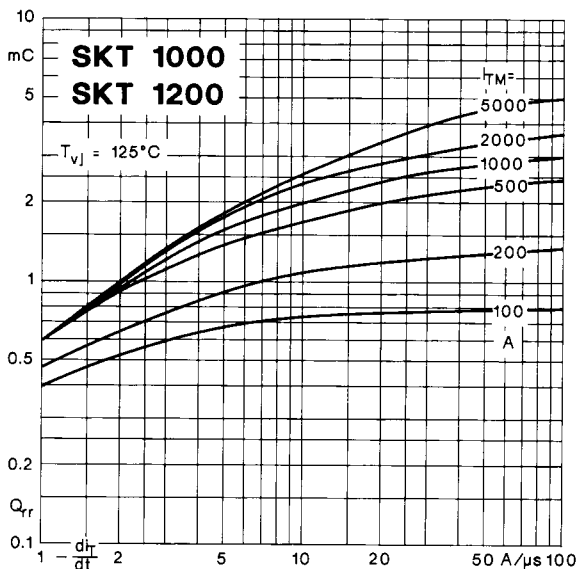

Fig. 3 Recovered charge vs. current decrease

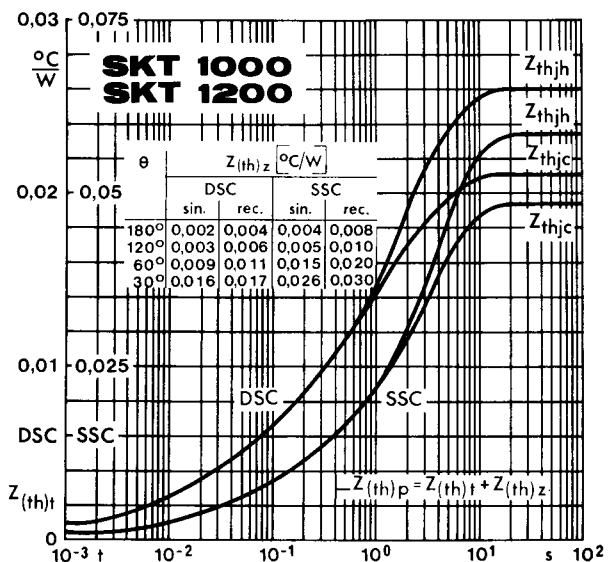

Fig. 4 Transient thermal impedance vs. time

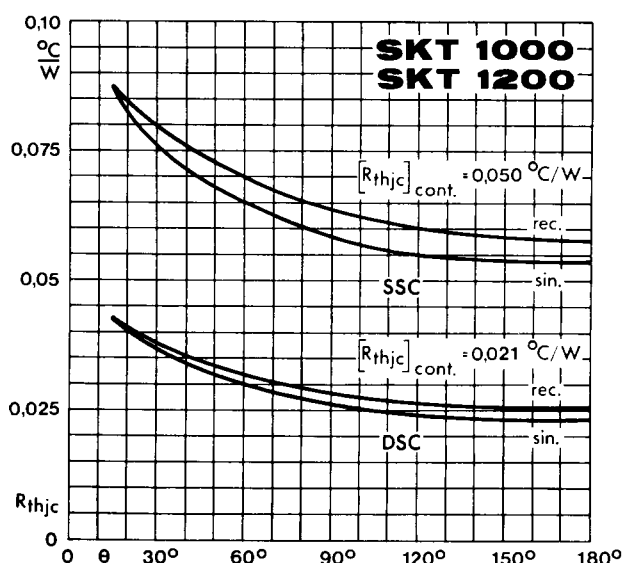

Fig. 5 Thermal resistance vs. conduction angle

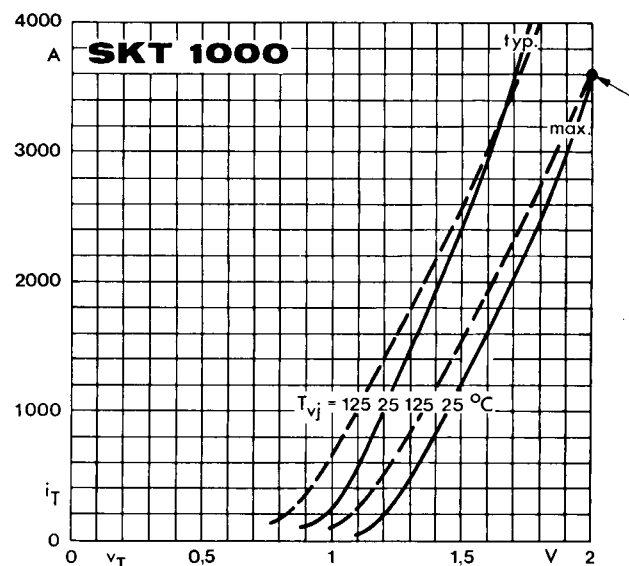

Fig. 6 a On-state characteristics

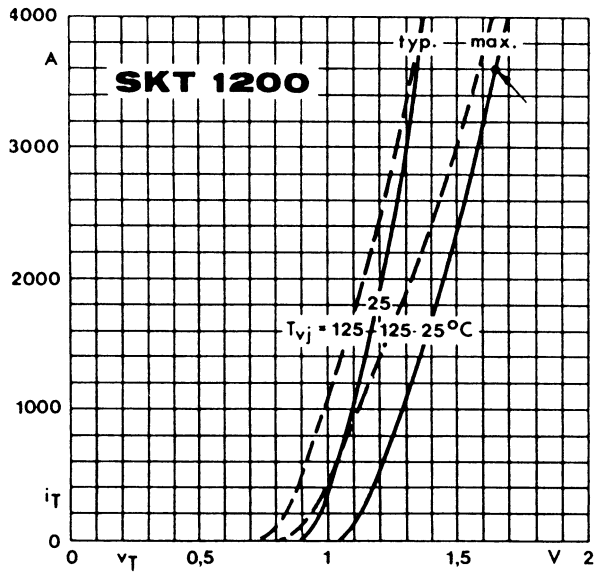

Fig. 6 b On-state characteristics

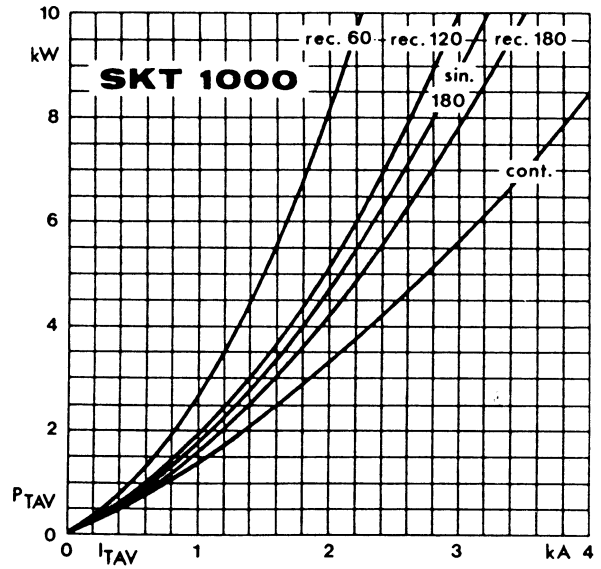

Fig. 7 a Power dissipation vs. on-state current

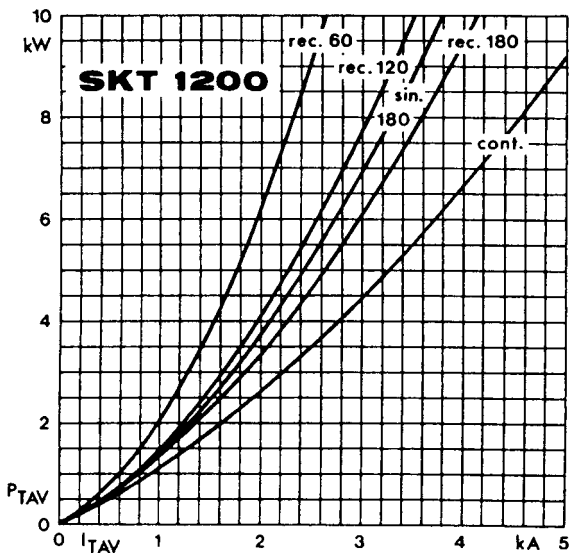

Fig. 7 b Power dissipation vs. on-state current

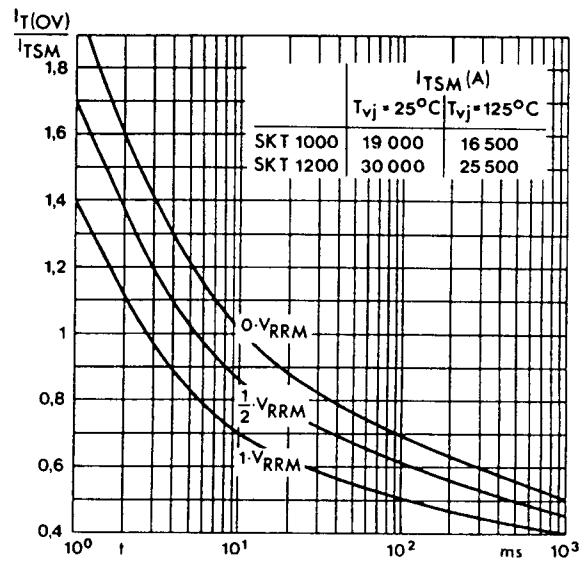

Fig. 8 Surge overload current vs. time

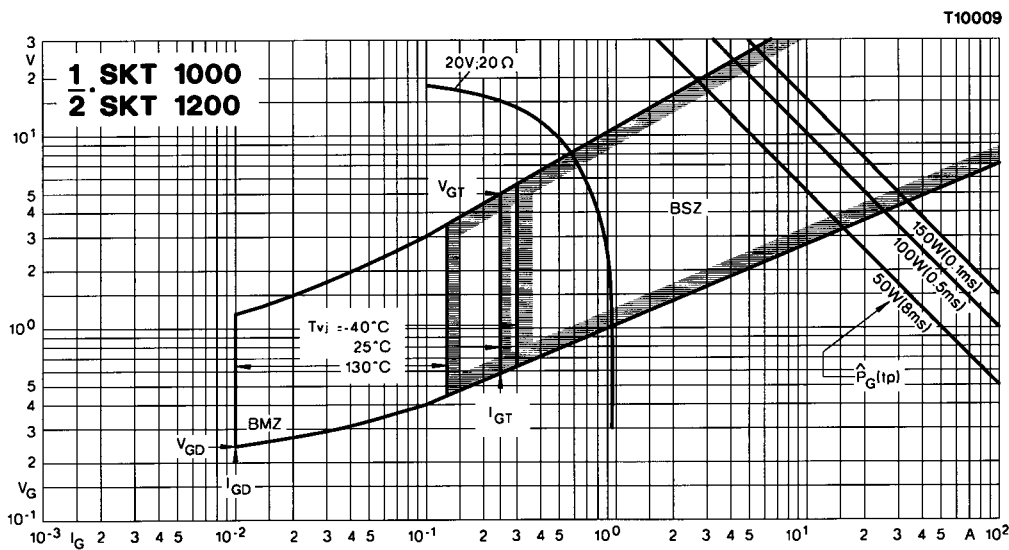
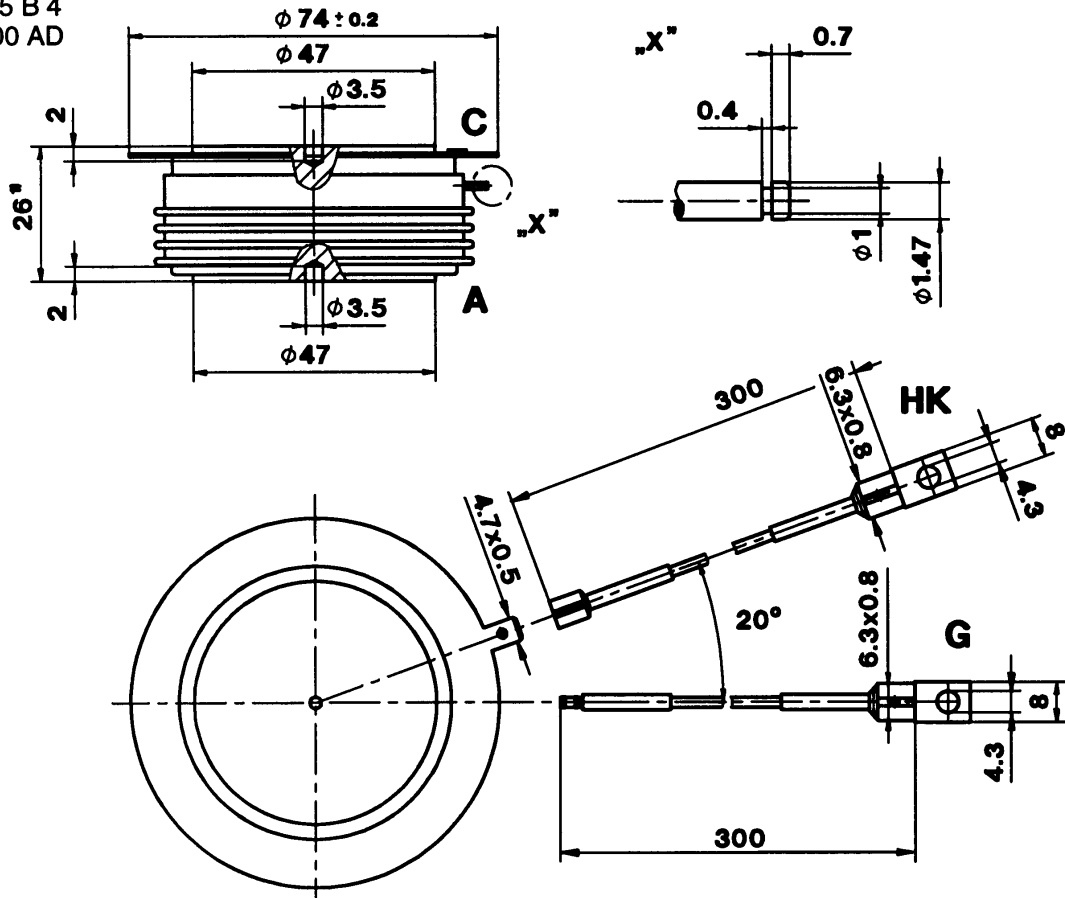

Fig. 9 Gate trigger characteristics

SKT 1000
SKT 1200

Case B 14

DIN 41814: 155 B 4
JEDEC: TO-200 AD



1) SKT 1000/... L 2: 27,5 mm

- C: Cathode terminal
- A: Anode terminal
- G: Gate terminal (yellow sleeve)
- HK: Auxiliary cathode terminal (red sleeve)

Dimensions in mm