

### General Description

The AAT2550 is a fully integrated total power solution with two step-down converters plus a single-cell lithium-ion / polymer battery charger. The step-down converter input voltage range spans 2.7V to 5.5V, making the AAT2550 ideal for systems powered by single-cell lithium-ion/polymer batteries.

The battery charger is a complete constant current/constant voltage linear charger. It offers an integrated pass device, reverse blocking protection, high current accuracy and voltage regulation, charge status, and charge termination. The charging current is programmable via external resistor from 100mA to 1A. In addition to these standard features, the device offers over-voltage, over-current, and thermal protection.

The two step-down converters are highly integrated, operating at a switching frequency of 1.4MHz, minimizing the size of external components while keeping switching losses low. Each converter has independent input, enable, and feedback pins. The output voltage ranges from 0.6V to  $V_{IN}$ . Each converter is capable of delivering up to 600mA of load current.

The AAT2550 is available in a Pb-free, space-saving, thermally-enhanced QFN44-24 package and is rated over the -40°C to +85°C temperature range.

### Features

- Two Step-Down Converters:
  - 600mA Output Current per Converter
  - $V_{IN}$  Range: 2.7V to 5.5V
  - 1.4MHz Switching Frequency
  - Low  $R_{DS(ON)}$  0.4Ω Integrated Power Switches
  - Internal Soft Start
  - 27μA Quiescent Current per Converter
- Highly Integrated Battery Charger:
  - Programmable Charging Current from 100mA to 1A
  - Pass Device
  - Reverse Blocking Diodes
  - Current Sensing Resistor
  - Digital Thermal Regulation
- Short-Circuit, Over-Temperature, and Current Limit Protection
- QFN44-24 Package
- -40°C to +85°C Temperature Range

### Applications

- Cellular Telephones
- Digital Cameras
- Handheld Instruments
- MP3, Portable Music, and Portable Media Players
- PDAs and Handheld Computers

### Typical Application

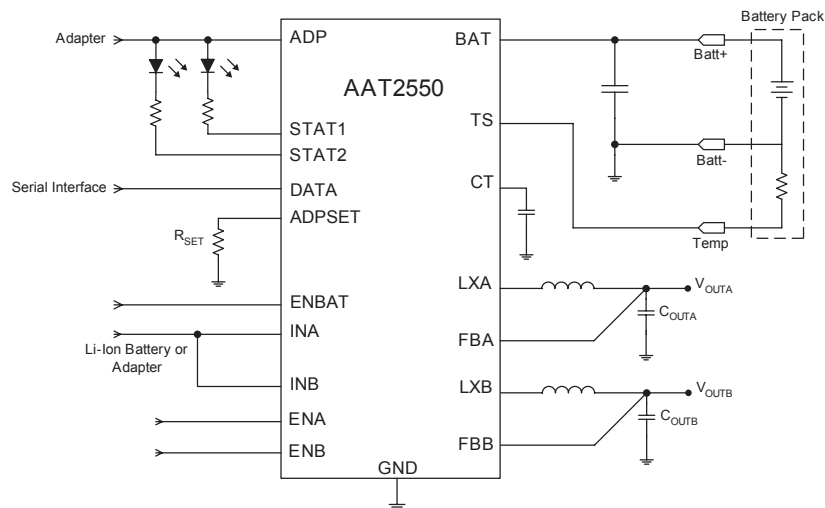

## Pin Descriptions

Pin #	Symbol	Function
1	ENA	Enable pin for Converter A. When connected to logic low, it disables the step-down converter and consumes less than 1 $\mu$ A of current. When connected to logic high, the converter operates normally.
2	LXA	Power switching node for Converter A. Connect the inductor to this pin. Internally, it is connected to the drain of both high- and low-side MOSFETs.
3, 17	PGND	Power ground. Connect the PGND pins together as close to the IC as possible. Connect AGND to PGND at a single point as close to the IC as possible.
4	DATA	Status report to the microcontroller via serial interface (open drain).
5, 7	N/C	Not connected.
6	ADPSET	Charge current set point. Connect a resistor from this pin to ground. Refer to Typical Characteristics curves for resistor selection.
8	BAT	Battery charging and sensing. Connect the positive terminal of the battery to BAT.
9	ADP	Input for adapter charger.
10, 11, 22	AGND	Analog signal ground. Connect AGND to PGND at a single point as close to the IC as possible.
12	ENBAT	Enable pin for the battery charger. When connected to logic low, the battery charger is disabled and consumes less than 1 $\mu$ A of current. When connected to logic high, the charger operates normally.
13	TS	Temperature sense input. Connect to a 10k $\Omega$ NTC thermistor.
14	STAT2	Battery charge status indicator pin to drive an LED. It is an open drain input.
15	STAT1	Battery charge status indicator pin to drive an LED. It is an open drain input.
16	CT	Timing capacitor to adjust internal watchdog timer. Sets maximum charge time for adapter powered trickle, constant current, and constant voltage charge modes.
18	LXB	Power switching node for Converter B. Connect the inductor to this pin. Internally, it is connected to the drain of both high- and low-side MOSFETs.
19	ENB	Enable pin for Converter B. When connected to logic low, it disables the step-down converter and consumes less than 1 $\mu$ A of current. When connected to logic high, the converter operates normally.
20	INB	Input voltage for Converter B.
21	FBB	Output voltage feedback input for Converter B. FBB senses the output voltage for regulation control. For fixed output versions, connect FBB to the output voltage. For adjustable versions, drive FBB from the output voltage through a resistive voltage divider. The FBB regulation threshold is 0.6V.
23	FBA	Output voltage feedback input for Converter A. FBA senses the output voltage for regulation control. For fixed output versions, connect FBA to the output voltage. For adjustable versions, drive FBA from the output voltage through a resistive voltage divider. The FBA regulation threshold is 0.6V.
24	INA	Input voltage for Converter A.
EP		Exposed paddle; connect to ground directly beneath the package.

### Pin Configuration

QFN44-24  
(Top View)

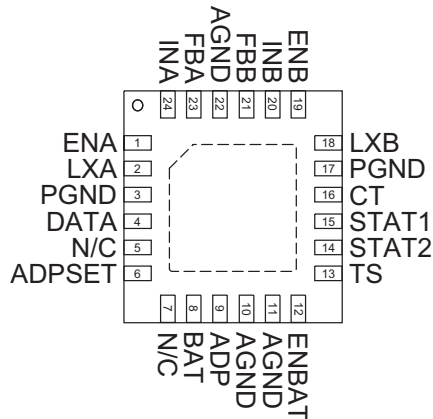

### Absolute Maximum Ratings<sup>1</sup>

Symbol	Description	Value	Units
$V_{INA/B}, V_{ADP}$	INA, INB, and ADP Voltages to GND	-0.3 to 6.0	V
$V_{LXA/B}, V_{FBA/B}$	$V_{LXA}, V_{LXB}, V_{FBA},$ and $V_{FBB}$ to GND	-0.3 to $V_{INA/B}, V_{ADP} + 0.3$	V
$V_X$	Voltage on All Other Pins to GND	-0.3 to 6.0	V
$T_J$	Operating Junction Temperature Range	-40 to 150	°C
$T_{LEAD}$	Maximum Soldering Temperature (at leads, 10 sec)	300	°C

### Thermal Information

Symbol	Description	Value	Units
$P_D$	Maximum Power Dissipation	2.0	W
$\theta_{JA}$	Thermal Resistance <sup>2</sup>	50	°C/W

1. Stresses above those listed in Absolute Maximum Ratings may cause permanent damage to the device. Functional operation at conditions other than the operating conditions specified is not implied. Only one Absolute Maximum Rating should be applied at any one time.  
2. Mounted on an FR4 printed circuit board.

### Electrical Characteristics<sup>1</sup>

$V_{IN} = 3.6V$ ;  $T_A = -40^{\circ}C$  to  $+85^{\circ}C$ , unless otherwise noted. Typical values are at  $T_A = 25^{\circ}C$ .

Symbol	Description	Conditions	Min	Typ	Max	Units
<b>Step-Down Converters A and B</b>						
$V_{IN}$	Input Voltage		2.7		5.5	V
$V_{UVLO}$	Under-Voltage Lockout Threshold	$V_{IN}$ Rising			2.7	V
		Hysteresis		100		mV
		$V_{IN}$ Falling	1.8			V
$V_{OUT}$	Output Voltage Tolerance	$I_{OUT} = 0$ to $600mA$ , $V_{IN} = 2.7V$ to $5.5V$	-3.0		3.0	%
$V_{OUT}$	Output Voltage Range		0.6		$V_{IN}$	V
$I_{OUT}$	Output Current	Per Converter			600	mA
$I_Q$	Quiescent Current	Each Converter		27	70	$\mu A$
$I_{SHDN}$	Shutdown Current	$V_{ENA} = V_{ENB} = GND$			1.0	$\mu A$
$I_{LIM}$	P-Channel Current Limit	Each Converter	0.8	1.0		A
$I_{LX\_LEAK}$	LX Leakage Current	$V_{IN} = 5.5V$ , $V_{LX} = 0$ to $V_{IN}$ , $V_{ENA} = V_{ENB} = GND$			1.0	$\mu A$
$I_{FB\_LEAK}$	Feedback Leakage	$V_{FB} = 0.6V$			0.2	$\mu A$
$R_{FB}$	FB Impedance	$V_{OUT} > 0.6V$	250			$k\Omega$
$V_{FB}$	Feedback Threshold Voltage Accuracy (0.6V Adjustable Version)	No Load, $T_A = 25^{\circ}C$	0.591	0.6	0.609	V
$R_{DS(ON)H}$	High-Side Switch On Resistance			0.45		$\Omega$
$R_{DS(ON)L}$	Low-Side Switch On Resistance			0.40		$\Omega$
$\Delta V_{LineReg}$	Line Regulation	$V_{IN} = 2.7V$ to $5.5V$		0.1		%/V
$F_{OSC}$	Switching Frequency			1.4		MHz
$T_{SD}$	Over-Temperature Shutdown Threshold			140		$^{\circ}C$
$T_{HYS}$	Over-Temperature Shutdown Hysteresis			15		$^{\circ}C$
$V_{EN(L)}$	Enable Threshold Low				0.6	V
$V_{EN(H)}$	Enable Threshold High		1.4			V

1. The AAT2550 is guaranteed to meet performance specifications over the  $-40^{\circ}C$  to  $+85^{\circ}C$  operating temperature range and is assured by design, characterization, and correlation with statistical process controls.

### Electrical Characteristics<sup>1</sup>

$V_{ADP} = 5V$ ;  $T_A = -40^{\circ}C$  to  $+85^{\circ}C$ , unless otherwise noted. Typical values are at  $T_A = 25^{\circ}C$ .

Symbol	Description	Conditions	Min	Typ	Max	Units
<b>Battery Charger</b>						
$V_{ADP}$	Adapter Voltage Range		4.0		5.5	V
$V_{UVLO}$	Under-Voltage Lockout	Rising Edge		3.0		V
	UVLO Hysteresis			150		mV
$I_Q$	Quiescent Current	$I_{CHARGE} = 100mA$		0.75	3.0	mA
$I_{SLEEP}$	Sleep Mode Current	$V_{BAT} = 4.25V$		0.3	1.0	$\mu A$
$I_{LEAKAGE}$	Reverse Leakage Current	$V_{BAT} = 4V$ , ADP Pin Open		1.0		$\mu A$
$I_{SHDN}$	Shutdown Current	$V_{EN} = GND$			1.0	$\mu A$
$V_{BAT\_EOC}^2$	End of Charge Voltage Accuracy		4.158	4.2	4.242	V
$\Delta V_{CH}/V_{CH}$	Output Charge Voltage Tolerance			0.5		%
$V_{MIN}$	Preconditioning Voltage Threshold		2.80	3.0	3.15	V
$V_{RCH}$	Battery Recharge Voltage Threshold			$V_{BAT\_EOC} - 0.1$		V
$I_{CH}$	Charge Current		100		1000	mA
$\Delta I_{CH}/I_{CH}$	Charge Current Regulation Tolerance			10		%
$V_{ADPSET}$	ADPSET Pin Voltage	Constant Current Mode		2.0		V
$K_{IA}$	Current Set Factor: $I_{CH}/I_{ADPSET}$			4000		
$R_{DS(ON)}$	Charger Pass Device	$V_{IN} = 5.5V$	0.20	0.25	0.35	$\Omega$
$T_C$	Constant Current Mode Time-Out	$C_T = 100nF$ , $V_{ADP} = 5.5V$		3.0		Hour
$T_P$	Preconditioning Time-Out	$C_T = 100nF$ , $V_{ADP} = 5.5V$		25		Minute
$T_V$	Constant Voltage Mode Time-Out	$C_T = 100nF$ , $V_{ADP} = 5.5V$		3.0		Hour
$V_{STAT}$	Output Low Voltage	$I_{SINK} = 4mA$			0.4	V
$I_{STAT}$	STAT Sink Current			8.0		mA
$V_{OVP}$	Over-Voltage Protection			4.4		V
$I_{TK}/I_{CH}$	Pre-Charge Current			10		%
$I_{TERM}/I_{CH}$	Charge Termination Threshold Current			7.5		%
$I_{TS}$	Current Source from TS Pin		70	80	90	$\mu A$
$TS_1$	TS Hot Temperature Fault	Threshold	310	330	350	mV
		Hysteresis		15		
$TS_2$	TS Cold Temperature Fault	Threshold	2.2	2.3	2.4	V
		Hysteresis		10		
$I_{DATA}$	DATA Pin Sink Current	DATA Pin is Active Low	3.0			mA
$V_{DATA(H)}$	Input High Threshold		1.6			V
$V_{DATA(L)}$	Input Low Threshold				0.4	V
$S_{QPULSE}$	Status Request Pulse Width		200			ns
$T_{Period}$	System Clock Period			50		$\mu s$
$F_{DATA}$	Data Output Frequency			20		kHz
$T_{REG}$	Thermal Loop Regulation			90		$^{\circ}C$
$T_{LOOP\_IN}$	Thermal Loop Entering Threshold			110		$^{\circ}C$
$T_{LOOP\_OUT}$	Thermal Loop Exiting Threshold			85		$^{\circ}C$
$T_{SD}$	Over-Temperature Shutdown Threshold			145		$^{\circ}C$

1. The AAT2550 is guaranteed to meet performance specifications over the  $-40^{\circ}C$  to  $+85^{\circ}C$  operating temperature range and is assured by design, characterization, and correlation with statistical process controls.
2. End of Charge Voltage Accuracy is specified over the  $0^{\circ}$  to  $70^{\circ}C$  ambient temperature range.

**Typical Characteristics—Step-Down Converter**

**Efficiency vs. Load**  
( $V_{OUT} = 1.8V$ ;  $L = 4.7\mu H$ )

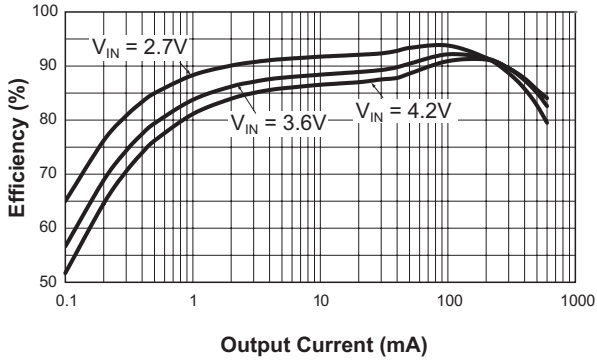

**DC Regulation**  
( $V_{OUT} = 1.8V$ )

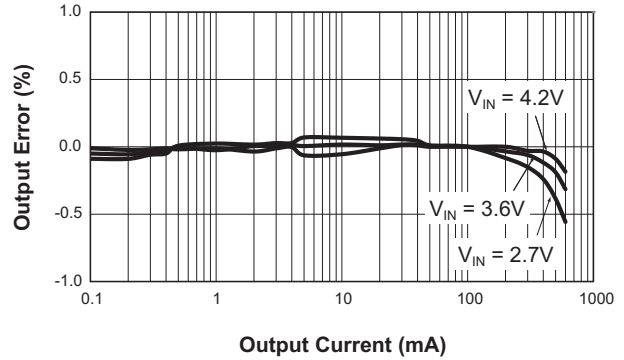

**Efficiency vs. Load**  
( $V_{OUT} = 2.5V$ ;  $L = 6.8\mu H$ )

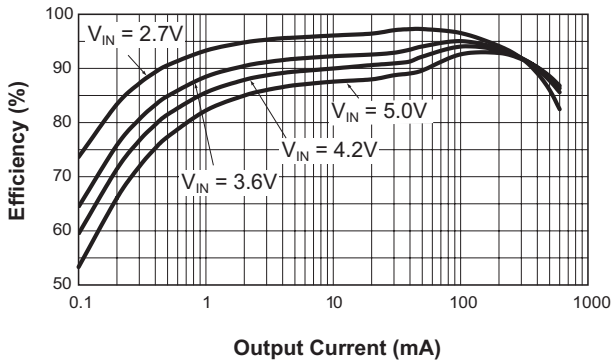

**DC Regulation**  
( $V_{OUT} = 2.5V$ )

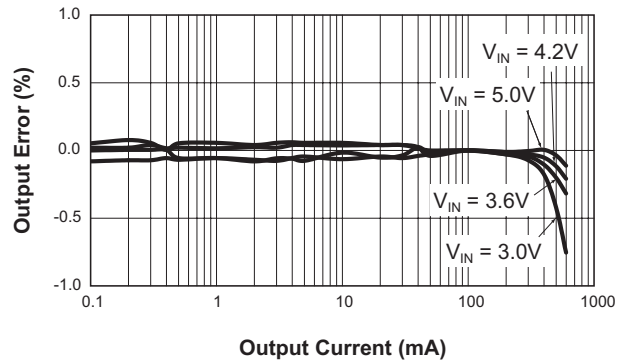

**Efficiency vs. Load**  
( $V_{OUT} = 3.3V$ ;  $L = 6.8\mu H$ )

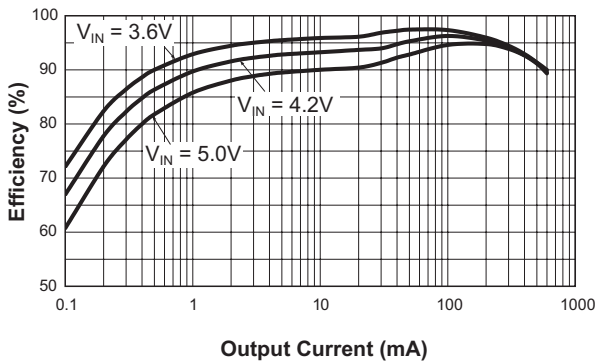

**DC Regulation**  
( $V_{OUT} = 3.3V$ ;  $L = 6.8\mu H$ )

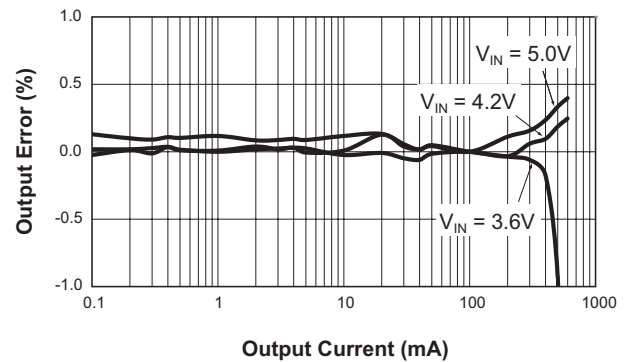

### Typical Characteristics—Step-Down Converter

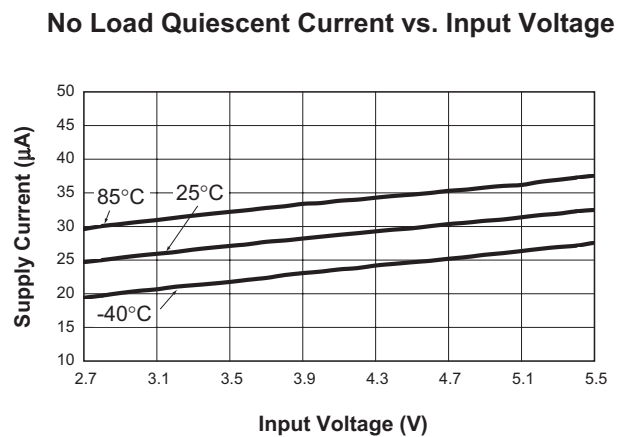
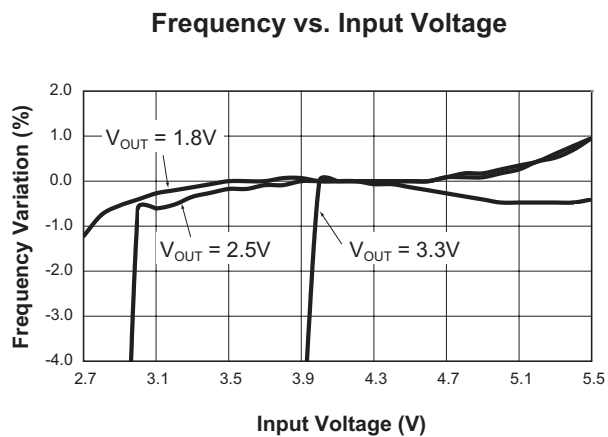
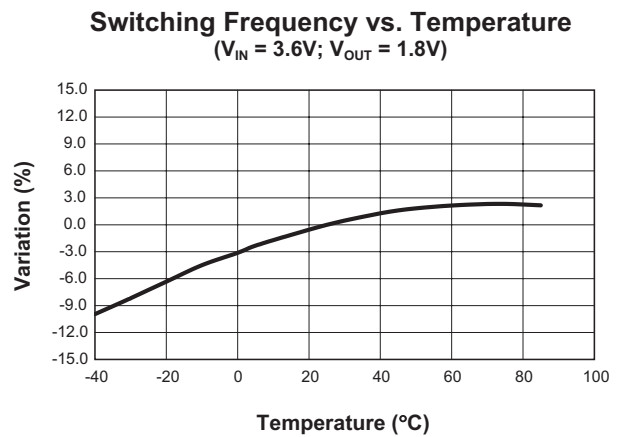
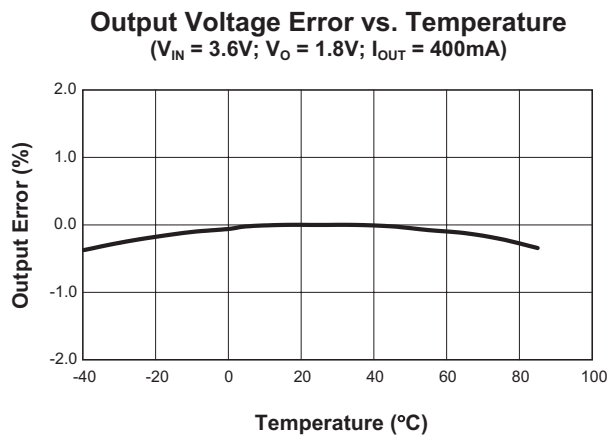
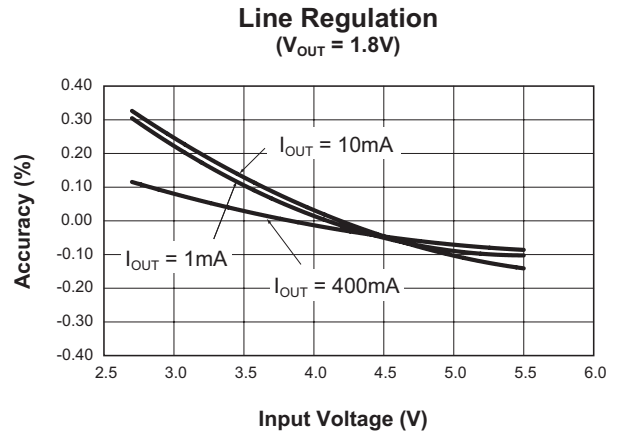
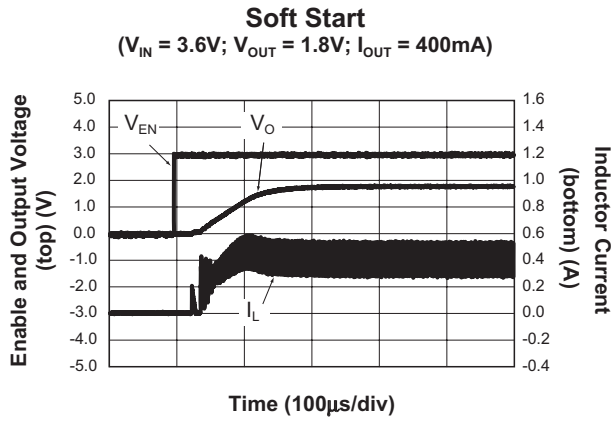

**Typical Characteristics—Step-Down Converter**

**P-Channel  $R_{DS(ON)}$  vs. Input Voltage**

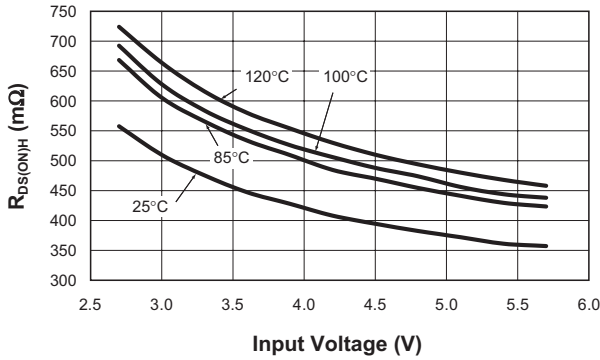

**N-Channel  $R_{DS(ON)}$  vs. Input Voltage**

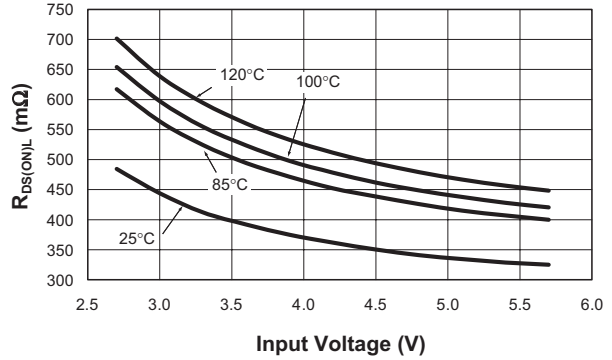

**Load Transient Response**  
(1mA to 300mA;  $V_{IN} = 3.6V$ ;  $V_{OUT} = 1.8V$ ;  
 $C_1 = 10\mu F$ ;  $C_{FF} = 100pF$ )

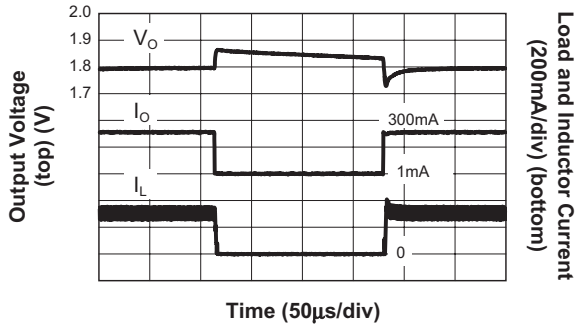

**Load Transient Response**  
(300mA to 400mA;  $V_{IN} = 3.6V$ ;  
 $V_{OUT} = 1.8V$ ;  $C_1 = 4.7\mu F$ )

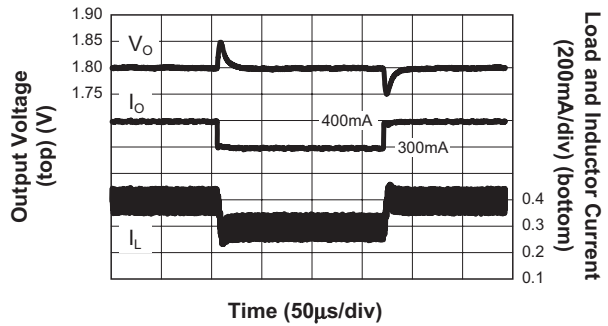

**Load Transient Response**  
(300mA to 400mA;  $V_{IN} = 3.6V$ ;  
 $V_{OUT} = 1.8V$ ;  $C_1 = 10\mu F$ )

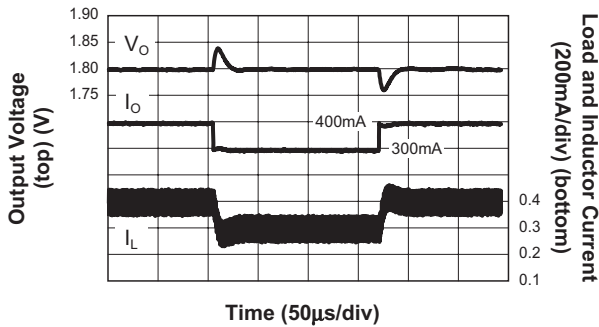

**Load Transient Response**  
(300mA to 400mA;  $V_{IN} = 3.6V$ ;  $V_{OUT} = 1.8V$ ;  
 $C_1 = 10\mu F$ ;  $C_4 = 100pF$ )

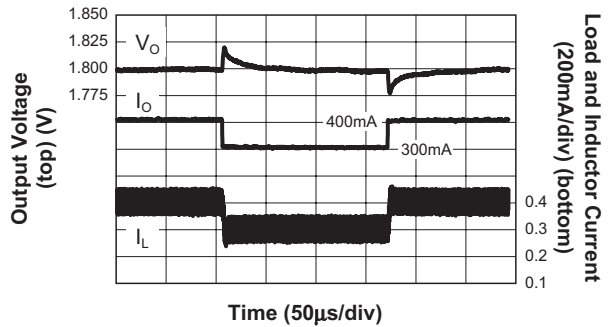



## Typical Characteristics—Step-Down Converter

**Line Response**  
( $V_{OUT} = 1.8V @ 400mA$ )

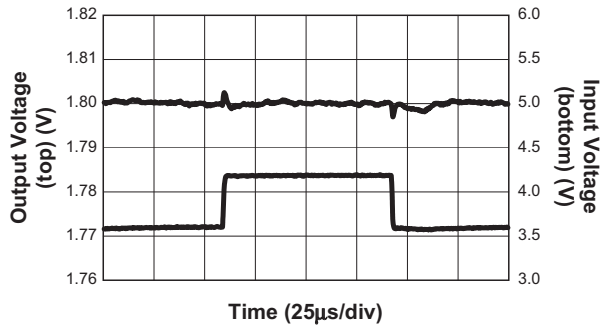

**Output Ripple**  
( $V_{IN} = 3.6V; V_{OUT} = 1.8V; I_{OUT} = 1mA$ )

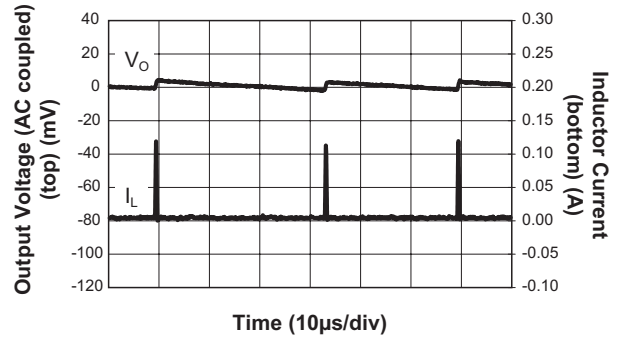

**Output Ripple**  
( $V_{IN} = 3.6V; V_{OUT} = 1.8V; I_{OUT} = 400mA$ )

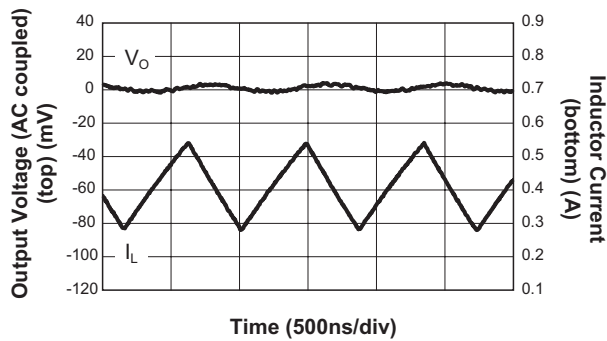

**Typical Characteristics—Battery Charger**

**$I_{FASTCHARGE}$  vs.  $R_{SET}$**

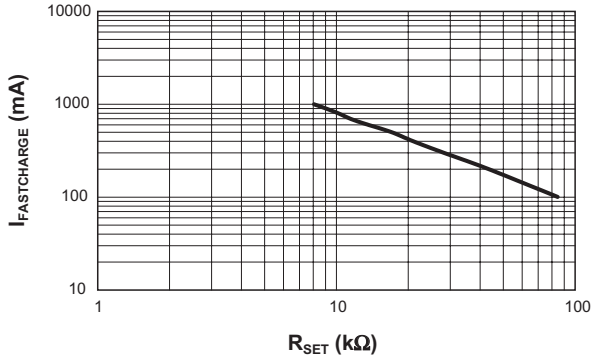

**Battery Voltage vs. Supply Voltage**

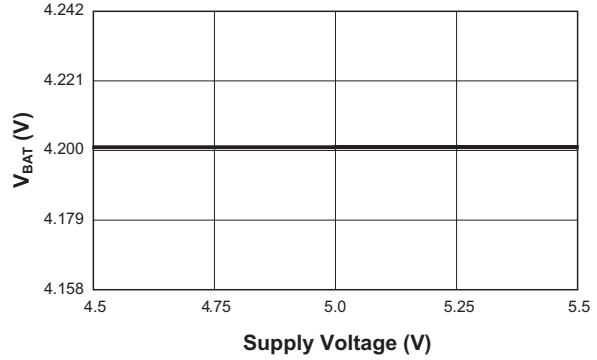

**End of Charge Voltage Regulation vs. Temperature**

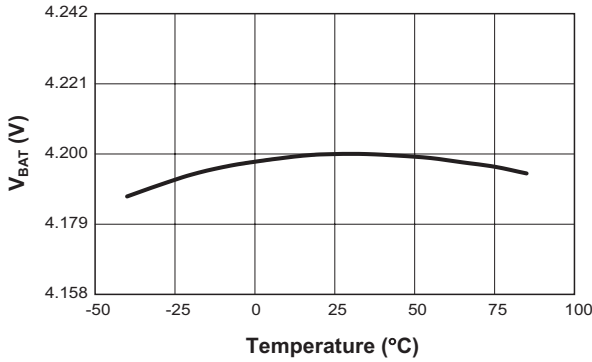

**Preconditioning Threshold Voltage vs. Temperature**

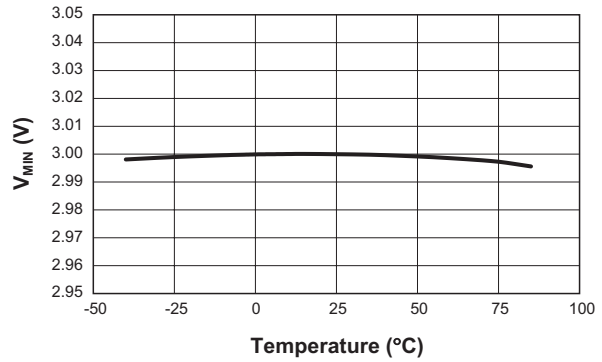

**Preconditioning  $I_{CH}$  vs. Temperature (ADPSET = 8.06kΩ)**

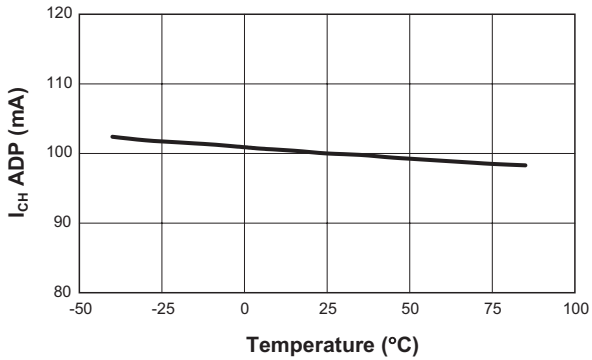

**Fast Charge Current vs. Temperature (ADPSET = 8.06kΩ)**

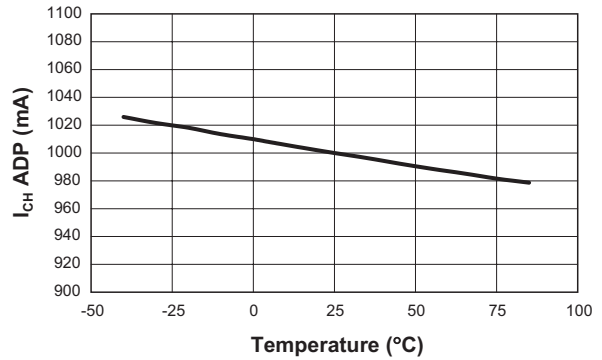

### Typical Characteristics—Battery Charger

**Charging Current vs. Battery Voltage**  
(ADPSET = 8.06kΩ; V<sub>IN</sub> = 5.0V)

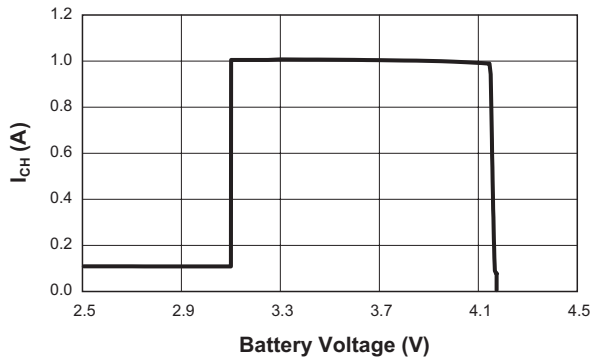

**Fast Charge Current vs. Supply Voltage**  
(ADPSET = 8.06kΩ)

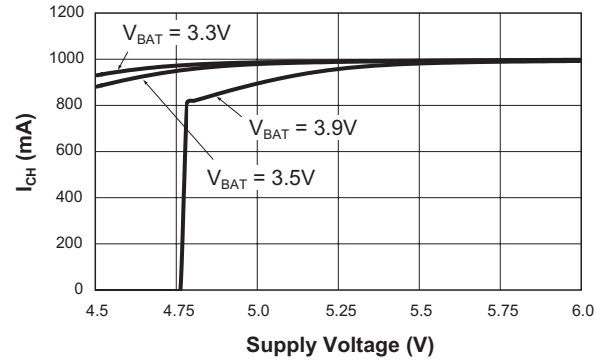

**V<sub>IH</sub> vs. Supply Voltage**  
EN Pin (Rising)

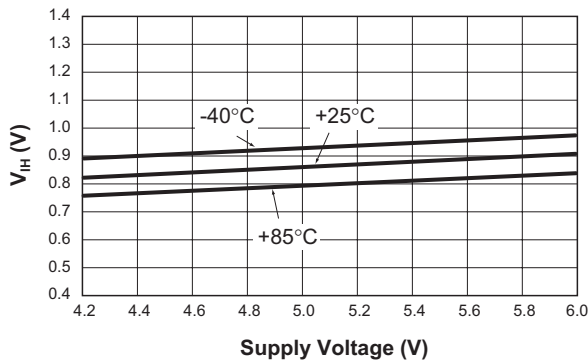

**V<sub>IL</sub> vs. Supply Voltage**  
EN Pin (Falling)

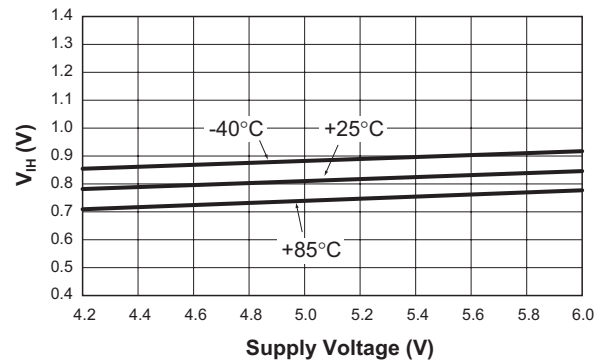

**Adapter Mode Supply Current vs. ADPSET Resistor**

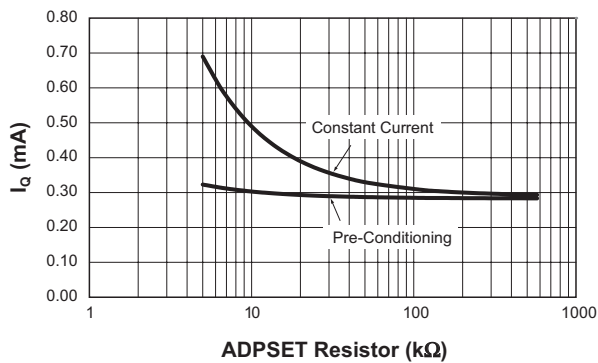

**Counter Timeout vs. Temperature**  
(CT = 0.1μF)

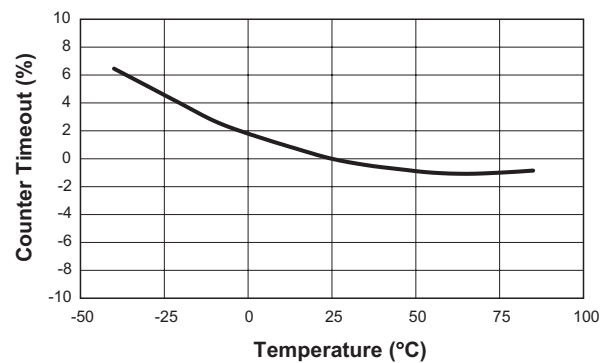

## Typical Characteristics—Battery Charger

CT Pin Capacitance vs. Counter Timeout

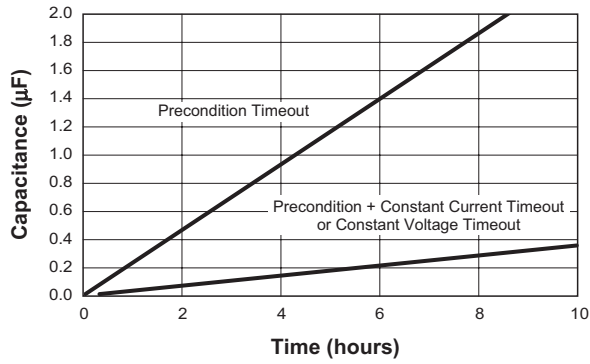

Temperature Sense Output Current vs. Temperature

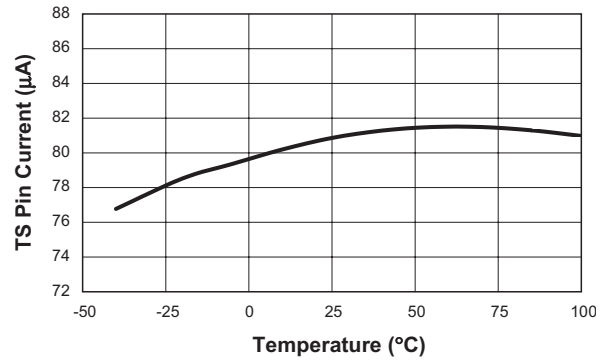

### Functional Block Diagram

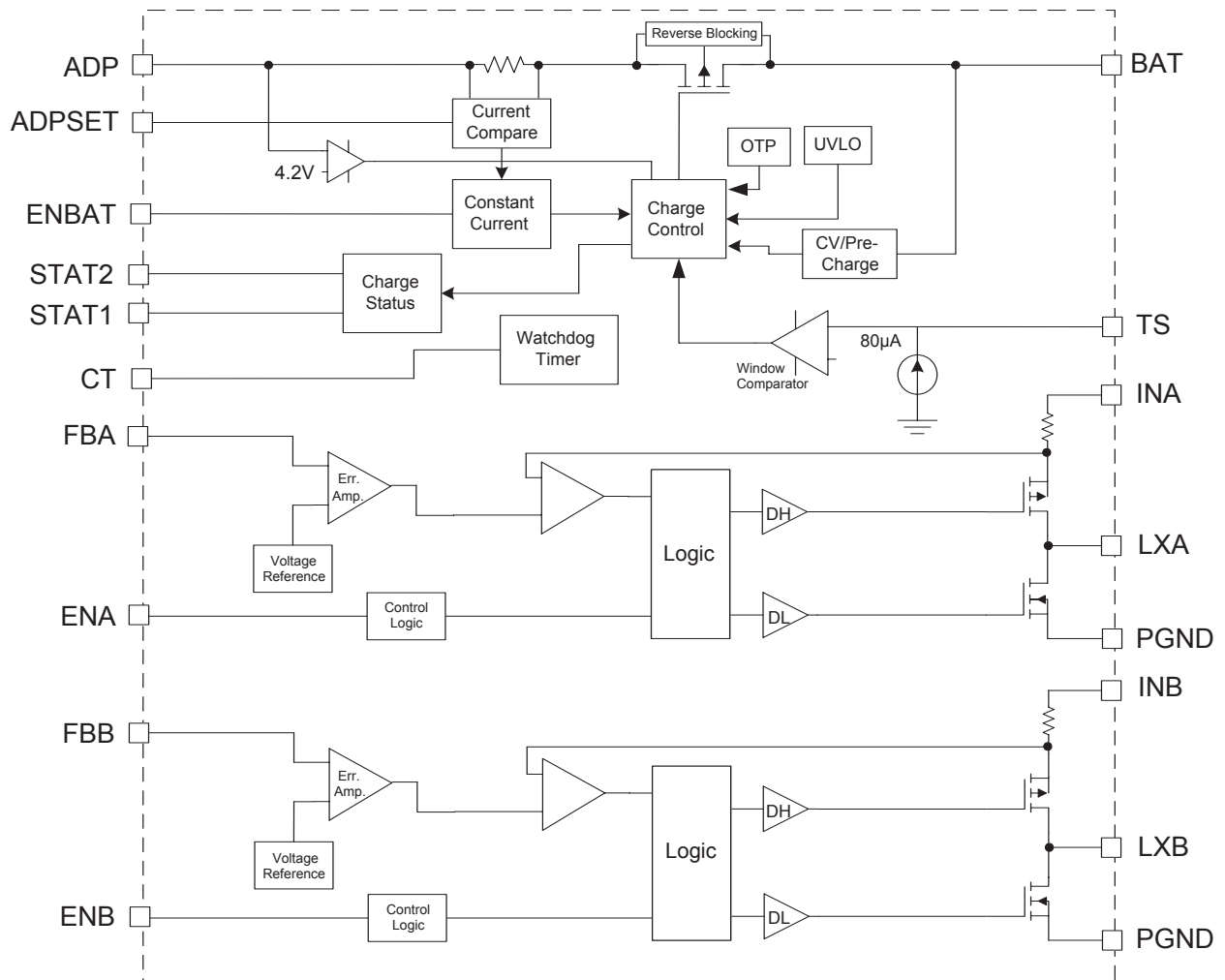

### Functional Description

The AAT2550 is a highly integrated power management IC comprised of a battery charger and two step-down voltage converters. The battery charger is designed for charging single-cell lithium-ion / polymer batteries. Featuring an integrated pass

device and reverse blocking, it offers a constant current / constant voltage charge algorithm with a user-programmable charge current level. The two step-down converters have been designed to minimize external component size and maximize efficiency over the entire load range. Each converter has independent enable and input voltage pins and can provide 600mA of load current.

### Battery Charger

The battery charger is designed to operate with standard AC adapter input sources, while requiring a minimum number of external components. It precisely regulates charge voltage and current for single-cell lithium-ion / polymer batteries.

The adapter charge input constant current level may be programmed up to 1A for rapid charging applications. The battery charger features thermal loop charge reduction. In the event of operating ambient temperatures exceeding the power dissipation abilities of the device package for a given constant current charge level, the charge control will enter into thermal regulation. When the system thermal regulation becomes active, the programmed constant current charge amplitude will automatically decrease to a safe level for the present operating conditions. If the ambient temperature drops to a level sufficient to allow the device to come out of thermal regulation, then the system will automatically resume charging at the full programmed constant current level. This intelligent thermal management system permits the battery charger to operate and charge a battery cell safely over a wide range of ambient conditions, while maximizing the greatest possible charge current and minimizing the battery charge time for a given set of conditions.

Status monitor output pins are provided to indicate the battery charge state by directly driving two external LEDs. A serial interface output is also available to report any one of 12 distinct charge states to the host system microcontroller / micro-processor. Battery temperature and charge state are fully monitored for fault conditions. In the event of an over-voltage or over-temperature condition, the device will automatically shut down, protecting the charging device, control system, and the battery under charge. In addition to internal charge controller thermal protection, the charger also offers a temperature sense feedback function (TS pin) from the battery to shut down the device in the event the battery exceeds its own thermal limit during charging. All fault events are reported to the user either by simple status LEDs or via the DATA pin function.

### Charging Operation

As shown in Figure 1, there are four basic modes for the battery charge cycle:

1. Pre-conditioning / trickle charge
2. Constant current / fast charge
3. Constant voltage
4. End of charge

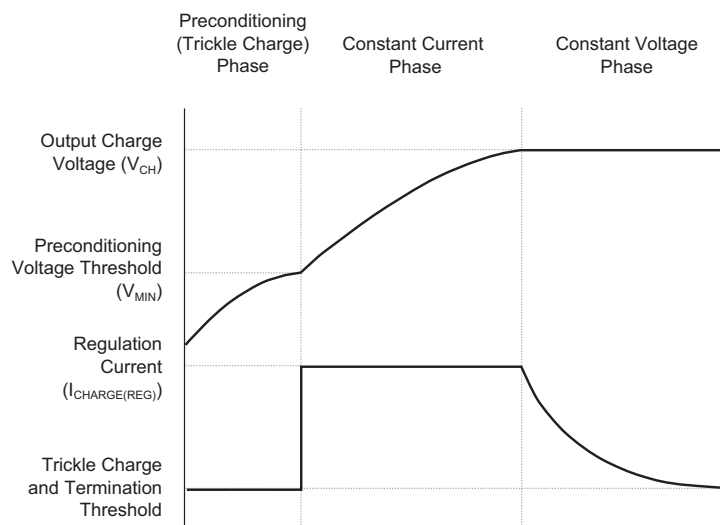

**Figure 1: Typical Charge Profile.**

## Battery Preconditioning

Before the start of charging, the charger checks several conditions in order to assure a safe charging environment. The input supply must be above the minimum operating voltage, or under-voltage lock-out threshold ( $V_{UVLO}$ ), for the charging sequence to begin. Also, the battery temperature, as reported by a thermistor connected to the TS pin from the battery, must be within the proper window for safe charging. When these conditions have been met and a battery is connected to the BAT pin, the charger checks the state of the battery. If the battery voltage is below the preconditioning voltage threshold ( $V_{MIN}$ ), then the charge control begins preconditioning the battery. The preconditioning trickle charge current is equal to the fast charge constant current divided by 10. For example, if the programmed fast charge current is 1A, then the preconditioning mode (trickle charge) current will be 100mA. Battery preconditioning is a safety precaution for deeply discharged batteries and also helps to limit power dissipation in the pass transistor when the voltage across the device is at the greatest potential.

## Fast Charge/Constant Current Charging

Battery preconditioning continues until the voltage on the BAT pin exceeds the preconditioning voltage threshold ( $V_{MIN}$ ). At this point, the charger begins the constant current fast charging phase. The fast charge constant current ( $I_{CH}$ ) amplitude is programmed by the user via the  $R_{SET}$  resistor. The charger remains in the constant current charge mode until the battery reaches the voltage regulation threshold,  $V_{BAT\_EOC}$ .

## Constant Voltage Charging

The system transitions to a constant voltage charging mode when the battery voltage reaches the output charge regulation threshold ( $V_{BAT\_EOC}$ ) during the constant current fast charge phase. The regulation voltage level is factory programmed to 4.2V ( $\pm 1\%$ ). The charge current in the constant voltage mode drops as the battery under charge reaches its maximum capacity.

## End of Charge Cycle Termination and Recharge Sequence

When the charge current drops to 7.5% of the programmed fast charge current level in the constant voltage mode, the device terminates charging and

goes into a sleep state. The charger will remain in a sleep state until the battery voltage decreases to a level below the battery recharge voltage threshold ( $V_{RCH}$ ). When the input supply is disconnected, the charger will automatically transition into a power-saving sleep mode. Consuming only an ultra-low 0.3 $\mu$ A in sleep mode, the charger minimizes battery drain when it is not charging. This feature is particularly useful in applications where the input supply level may fall below the battery charge or under-voltage lockout level. In such cases where the input voltage drops, the device will enter sleep mode and resume charging automatically once the input supply has recovered from the fault condition.

## Step-Down Converters

The AAT2550 offers two high-performance, 600mA, 1.4MHz step-down converters. Both converters minimize external component size and optimize efficiency over the entire load range. The fixed output version requires only three external power components ( $C_{IN}$ ,  $C_{OUT}$ , and L) for each converter. The adjustable version is programmed with external feedback resistors to any voltage ranging from 0.6V to the input voltage. At dropout, the converter duty cycle increases to 100% and the output voltage tracks the input voltage minus the  $R_{DS(ON)}$  drop of the P-channel MOSFET.

Input voltage range is 2.7V to 5.5V and each converter's efficiency has been optimized for all load conditions, ranging from no load to 600mA. The internal error amplifier and compensation provides excellent transient response, load regulation, and line regulation. Soft start eliminates output voltage overshoot when the enable or the input voltage is applied.

## Soft Start / Enable

The internal soft start limits the inrush current during start-up. This prevents possible sagging of the input voltage and eliminates output voltage overshoot. Typical start-up time for a 4.7 $\mu$ F output capacitor and load current of 600mA is 100 $\mu$ s.

The AAT2550 offers independent enable pins for each converter. When connected to logic low, the enable input forces the respective step-down converter into a low-power, non-switching, shutdown state. The total input current during shutdown is less than 1 $\mu$ A for each channel.

### System Operation Flow Chart

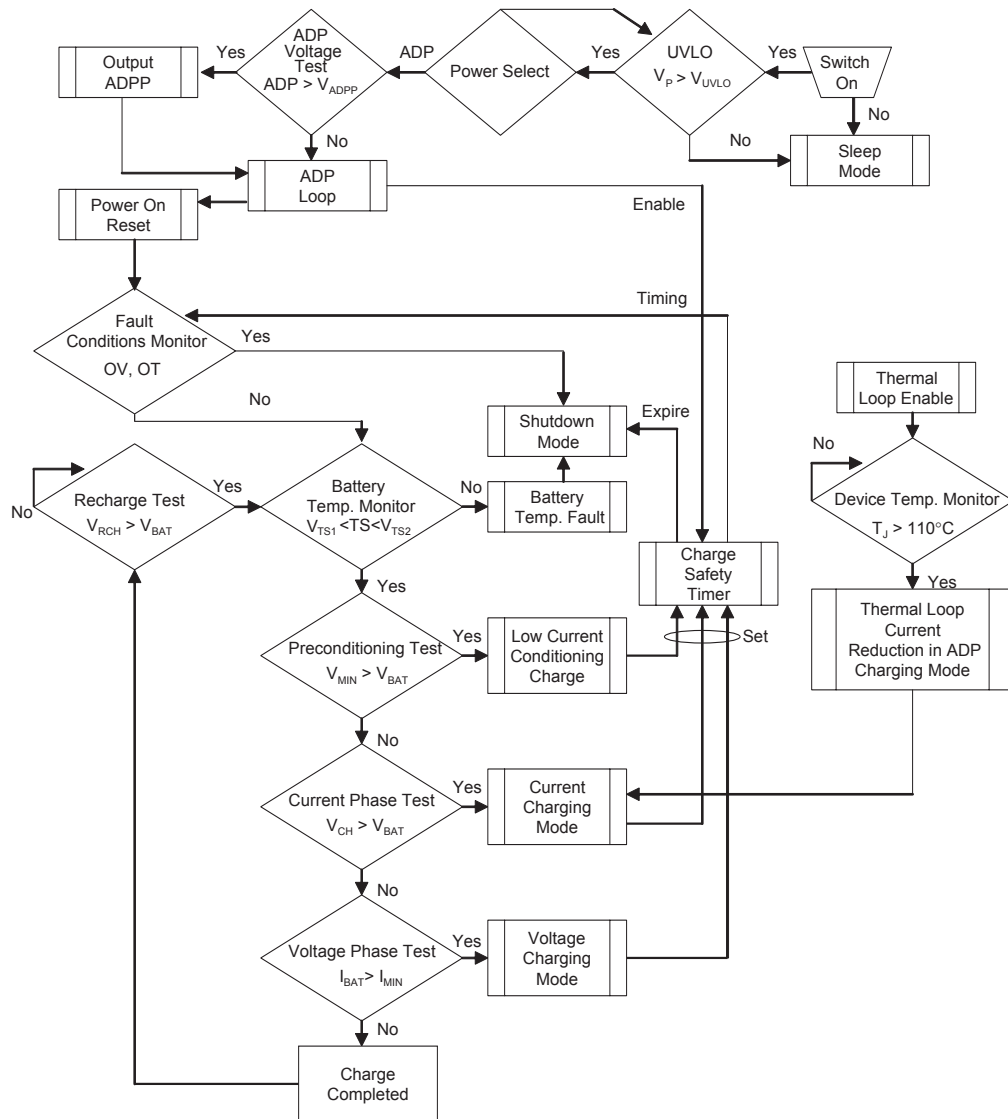

### Current Limit and Over-Temperature Protection

For overload conditions, the peak input current is limited. To minimize power dissipation and stresses under current limit and short-circuit conditions, switching is terminated after entering current limit for a series of pulses. Switching is terminated for seven consecutive clock cycles after a current limit has been sensed for a series of four consecutive clock cycles.

Thermal protection completely disables switching when internal dissipation becomes excessive. The

junction over-temperature threshold is 140°C with 15°C of hysteresis. Once an over-temperature or over-current fault conditions is removed, the output voltage automatically recovers.

### Under-Voltage Lockout

The under-voltage lockout circuit prevents the device from improper operation at low input voltages. Internal bias of all circuits is controlled via the VIN input. Under-voltage lockout (UVLO) guarantees sufficient V<sub>IN</sub> bias and proper operation of all internal circuitry prior to activation.



## Application Information

### AC Adapter Power Charging

The adapter constant current charge levels can be programmed up to 1A. The AAT2550 will operate from the adapter input over a 4.0V to 5.5V range.

The constant current fast charge current for the adapter input mode is set by the  $R_{SET}$  resistor connected between the ADPSET and ground. Refer to Table 1 for recommended  $R_{SET}$  values for a desired constant current charge level. The precise charging function in the adapter mode may be read from the DATA pin and/or status LEDs. Please refer to the Battery Charge Status Indication discussion in this datasheet for further details on data reporting.

### Thermal Loop Control

Due to the integrated nature of the linear charging control pass device, a special thermal loop control system has been employed to maximize charging current under all operation conditions. The thermal management system measures the internal circuit die temperature and reduces the fast charge current when the device exceeds a preset internal temperature control threshold. Once the thermal loop control becomes active, the fast charge current is initially reduced by a factor of 0.44.

The initial thermal loop current can be estimated by the following equation:

$$I_{TLOOP} = I_{CH} \cdot 0.44$$

The thermal loop control re-evaluates the circuit die temperature every three seconds and adjusts the fast charge current back up in small steps to the full fast charge current level or until an equilibrium current is discovered and maximized for the given ambient temperature condition. The thermal loop controls the system charge level; therefore, the AAT2550 will always provide the highest level of constant current possible in the fast charge mode for any given ambient temperature condition.

### Adapter Input Charge Inhibit and Resume

The AAT2550 has an under-voltage lockout and power on reset feature so that the charger will suspend charging and shut down if the input supply to the adapter pin drops below the UVLO threshold.

When power is re-applied to the adapter pin or the UVLO condition recovers and  $ADP > V_{BAT}$ , the system charge control will assess the state of charge on the battery cell and will automatically resume charging in the appropriate mode for the condition of the battery.

$I_{CH}$	ADP $R_{SET}$ (k $\Omega$ )
100	84.5
200	43.2
300	28.0
400	21.0
500	16.9
600	13.3
700	11.5
800	10.2
900	9.09
1000	8.06

**Table 1: Resistor Values.**

### Enable / Disable

The AAT2550 provides an enable function to control the charger IC on and off. The enable (EN) pin is active high. When pulled to a logic low level, the AAT2550 will be shut down and forced into the sleep state. Charging will be halted regardless of the battery voltage or charging state. When the device is re-enabled, the charge control circuit will automatically reset and resume charging functions with the appropriate charging mode based on the battery charge state and measured cell voltage.

### Programming Charge Current

The fast charge constant current charge level is programmed with a resistor placed between the ADPSET pin and ground. The accuracy of the fast charge, as well as the preconditioning trickle charge current, is dominated by the tolerance of the set resistor used. For this reason, 1% tolerance metal film resistors are recommended for the set resistor function.

Fast charge constant current levels from 100mA to 1A can be set by selecting the appropriate resistor value from Table 1. The  $R_{SET}$  resistor should be connected between the ADPSET pin and ground.

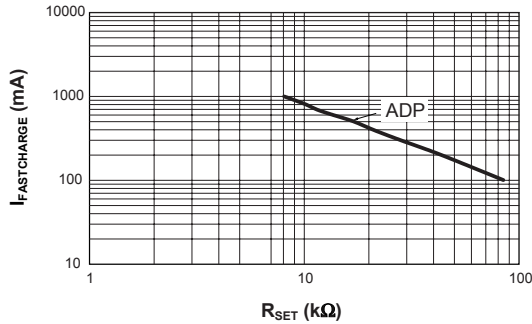

**Figure 2: I<sub>FASTCHARGE</sub> vs. R<sub>SET</sub>**

## Protection Circuitry

### Programmable Watchdog Timer

The AAT2550 contains a watchdog timing circuit for the adapter input charging mode. Typically, a 0.1μF ceramic capacitor is connected between the CT pin and ground. When a 0.1μF ceramic capacitor is used, the device will time a shutdown condition if the trickle charge mode exceeds 25 minutes and a combined trickle charge plus fast charge mode of three hours. When the device transitions to the constant voltage mode, the timing counter is reset and will time out after three hours and shut down the charger (see Table 2).

Mode	Time
Trickle Charge (TC) Time Out	25 minutes
Trickle Charge (TC) + Fast Charge (CC) Time Out	3 hours
Constant Voltage (VC) Mode Time Out	3 hours

**Table 2: Summary for a 0.1μF Used for the Timing Capacitor.**

The CT pin is driven by a constant current source and will provide a linear response to increases in the timing capacitor value. Thus, if the timing capacitor were to be doubled from the nominal 0.1μF value, the time-out durations would be doubled.

If the programmable watchdog timer function is not needed, it can be disabled by connecting the CT pin to ground. The CT pin should not be left float-

ing or un-terminated, as this will cause errors in the internal timing control circuit.

The constant current provided to charge the timing capacitor is very small, and this pin is susceptible to noise and changes in capacitance value. Therefore, the timing capacitor should be physically located on the printed circuit board layout as closely as possible to the CT pin. Since the accuracy of the internal timer is dominated by the capacitance value, 10% tolerance or better ceramic capacitors are recommended. Ceramic capacitor materials, such as X7R and X5R type, are a good choice for this application.

### Over-Voltage Protection

An over-voltage event is defined as a condition where the voltage on the BAT pin exceeds the maximum battery charge voltage and is set by the over-voltage protection threshold ( $V_{OVP}$ ). If an over-voltage condition occurs, the AAT2550 charge control will shut down the device until voltage on the BAT pin drops below the over-voltage protection threshold ( $V_{OVP}$ ). The AAT2550 will resume normal charging operation after the over-voltage condition is removed. During an over-voltage event, the STAT LEDs will report a system fault, and the actual fault condition may be read via the DATA pin signal.

### Over-Temperature Shutdown

The AAT2550 has a thermal protection control circuit which will shut down charging functions should the internal die temperature exceed the preset thermal limit threshold.

### Battery Temperature Fault Monitoring

In the event of a battery over-temperature condition, the charge control will turn off the internal pass device and report a battery temperature fault on the DATA pin function. The STAT LEDs will also display a system fault. After the system recovers from a temperature fault, the device will resume charging operation.

The AAT2550 checks battery temperature before starting the charge cycle, as well as during all stages of charging. This is accomplished by monitoring the voltage at the TS pin. This system is intended to use negative temperature coefficient thermistors (NTC), which are typically integrated into the battery package. Most of the commonly

used NTC thermistors in battery packs are approximately 10kΩ at room temperature (25°C).

The TS pin has been specifically designed to source 80μA of current to the thermistor. The voltage on the TS pin that results from the resistive load should stay within a window from 330mV to 2.3V. If the battery becomes too hot during charging due to an internal fault, the thermistor will heat up and reduce in value, pulling the TS pin voltage lower than the TS1 threshold, and the AAT2550 will signal the fault condition.

If the use of the TS pin function is not required by the system, it should be terminated to ground with a 10kΩ resistor.

### Battery Charge Status Indication

The AAT2550 indicates the status of the battery under charge with two different systems. First, the device has two status LED driver outputs. These two LEDs can indicate simple functions such as no battery charge activity, battery charging, charge complete, and charge fault. The AAT2550 also provides a bi-directional data reporting function so that a system microcontroller can interrogate the DATA pin and read any one of 13 system states.

#### Status Indicator Display

Simple system charging status states can be displayed using one or two LEDs in conjunction with the STAT1 and STAT2 pins on the AAT2550. These two pins are simple switches to connect the LED cathodes to ground. It is not necessary to use both display LEDs if a user simply wants to have a single lamp to show "charging" or "not charging." This can

be accomplished by using the STAT1 pin and a single LED. Using two LEDs and both STAT pins simply gives the user more information to the charging states. Refer to Table 3 for LED display definitions.

The LED anodes should be connected to ADP. The LEDs should be biased with as little current as necessary to create reasonable illumination; therefore, a ballast resistor should be placed between the LED cathodes and the STAT1/2 pins. LED current consumption will add to the overall thermal power budget for the device package, so it is wise to keep the LED drive current to a minimum. 2mA should be sufficient to drive most low-cost green or red LEDs. It is not recommended to exceed 8mA for driving an individual status LED.

The required ballast resistor value can be estimated using the following formulas:

For connection to the adapter supply:

$$R_{B(STAT1/2)} = \frac{V_{ADP} - V_{F(LED)}}{I_{LED(STAT1/2)}}$$

Example:

$$R_{B(STAT1)} = \frac{5.5V - 2.0V}{2mA} = 1.75k\Omega$$

Note: Red LED forward voltage ( $V_F$ ) is typically 2.0V @ 2mA. Green LED forward voltage ( $V_F$ ) is typically 3.2V @ 2mA.

The four status LED display conditions are described in Table 3.

Event Description	STAT1	STAT2
Charge Disabled or Low Supply	Off	Off
Charge Enabled Without Battery	Flash <sup>1</sup>	Flash <sup>1</sup>
Battery Charging	On	Off
Charge Completed	Off	On
Fault	On	On

**Table 3: Status LED Display Conditions.**

1. Flashing rate depends on output capacitance.

### Digital Charge Status Reporting

The AAT2550 has a comprehensive digital data reporting system by use of the DATA pin feature. This function can provide detailed information regarding the status of the charging system. The DATA pin is a bi-directional port which will read back a series of data pulses when the system microcontroller asserts a request pulse. This single strobe request protocol will invoke one of 13 possible return pulse counts which the microcontroller can look up based on the serial report table shown in Table 4.

The DATA pin function is active low and should normally be pulled high to  $V_{ADP}$ . This data line may also be pulled high to the same level as the high state for the logic I/O port on the system microcontroller. In order for the DATA pin control circuit to generate clean, sharp edges for the data output

and to maintain the integrity of the data timing for the system, the pull-up resistor on the data line should be low enough in value so that the DATA signal returns to the high state without delay. If too small a pull-up resistor is used, the strobe pulse from the system microcontroller could exceed the maximum pulse time and the DATA output control could issue false status reports. A 1.5kΩ resistor is recommended when pulling the DATA pin high to 5.0V. If the data line is pulled high to a voltage level less than 5.0V, the pull-up resistor can be calculated based on a recommended minimum pull-up current of 3mA. Use the following formula:

$$R_{PULL-UP} \leq \frac{V_{PULL-UP}}{3mA}$$

Number	DATA Report Status
1	Chip Over-Temperature Shutdown
2	Battery Temperature Fault
3	Over-Voltage Turn Off
4	Not Used
5	ADP Watchdog Time-Out in Battery Condition Mode
6	ADP Battery Condition Mode
7	ADP Watchdog Time-Out in Constant Current Mode
8	ADP Thermal Loop Regulation in Constant Current Mode
9	ADP Constant Current Mode
10	ADP Watchdog Time-Out in Constant Voltage Mode
11	ADP Constant Voltage Mode
12	ADP End of Charging
23	Data Report Error

**Table 4: Serial Data Report Table.**

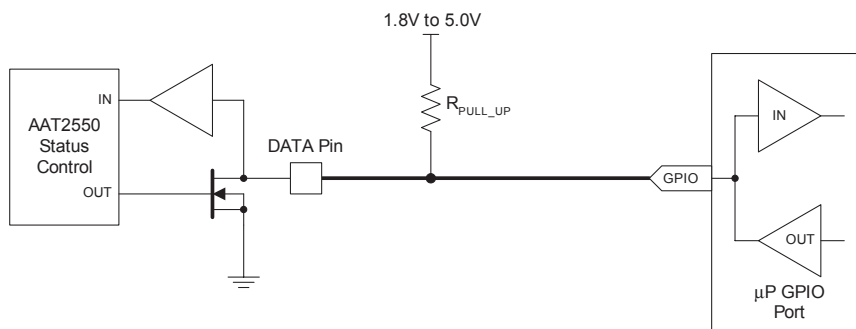

**Figure 3: Data Pin Application Circuit.**

### Data Timing

The system microcontroller should assert an active low data request pulse for minimum duration of 200ns; this is specified by the  $S_{QPULSE}$ . Upon sensing the rising edge of the end of the data request

pulse, the AAT2550 status data control will reply the data word back to the system microcontroller after a delay defined by the data report time specification  $T_{DATA(RPT)}$ . The period of the following group of data pulses will be defined by the  $T_{DATA}$  specification.

### Timing Diagram

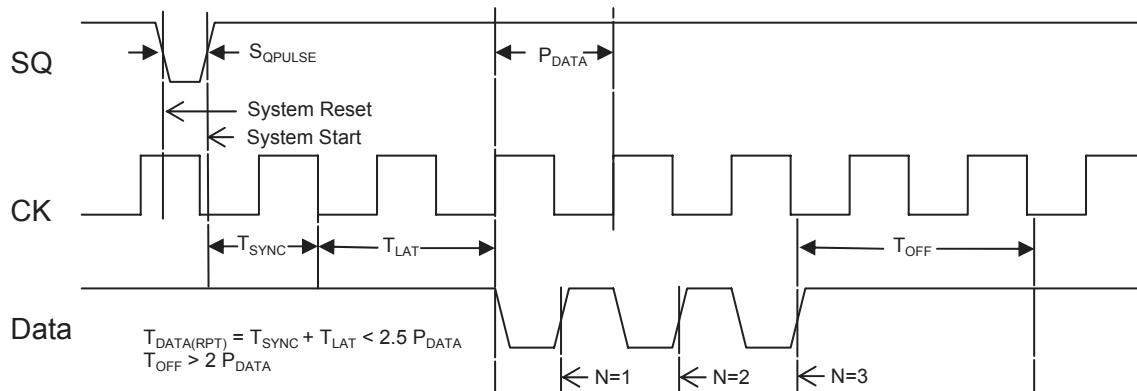

### Capacitor Selection

#### Input Capacitor

In general, it is good design practice to place a decoupling capacitor between the ADP pin and ground. An input capacitor in the range of 1 $\mu$ F to 22 $\mu$ F is recommended. If the source supply is unregulated, it may be necessary to increase the capacitance to keep the input voltage above the under-voltage lockout threshold during device enable and when battery charging is initiated.

If the AAT2550 adapter input is to be used in a system with an external power supply source, such as a typical AC-to-DC wall adapter, then a  $C_{IN}$  capacitor in the range of 10 $\mu$ F should be used. A larger

input capacitor in this application will minimize switching or power bounce effects when the power supply is "hot plugged."

#### Output Capacitor

The AAT2550 only requires a 1 $\mu$ F ceramic capacitor on the BAT pin to maintain circuit stability. This value should be increased to 10 $\mu$ F or more if the battery connection is made any distance from the charger output. If the AAT2550 is to be used in applications where the battery can be removed from the charger, such as in the case of desktop charging cradles, an output capacitor greater than 10 $\mu$ F may be required to prevent the device from cycling on and off when no battery is present.

## Step-Down Converter

### Functional Description

The AAT2550 step-down converter is a high performance 600mA 1.4MHz monolithic power supply. It has been designed with the goal of minimizing external component size and optimizing efficiency over the complete load range. Apart from the small bypass input capacitor, only a small L-C filter is required at the output. Typically, a 4.7μH inductor and a 4.7μF ceramic capacitor are recommended (see Table 5).

The fixed output version requires only three external power components ( $C_{IN}$ ,  $C_{OUT}$ , and L). The adjustable version can be programmed with external feedback to any voltage, ranging from 0.6V to the input voltage. An additional feed-forward capacitor can also be added to the external feedback with a 10μF output capacitor for improved transient response (see C10 and C11 in Figure 4).

At dropout, the converter duty cycle increases to 100% and the output voltage tracks the input voltage minus the  $R_{DS(ON)}$  drop of the P-channel high-side MOSFET.

The input voltage range is 2.7V to 5.5V. The converter efficiency has been optimized for all load conditions, ranging from no load to 600mA.

The internal error amplifier and compensation provides excellent transient response, load, and line regulation. Soft start eliminates any output voltage overshoot when the enable or the input voltage is applied.

### Control Loop

The AAT2550 step-down converter is a peak current mode control converter. The current through the P-channel MOSFET (high side) is sensed for current loop control, as well as short-circuit and overload protection. A fixed slope compensation signal is added to the sensed current to maintain stability for duty cycles greater than 50%. The peak current mode loop appears as a voltage-pro-

grammed current source in parallel with the output capacitor.

The output of the voltage error amplifier programs the current mode loop for the necessary peak switch current to force a constant output voltage for all load and line conditions. Internal loop compensation terminates the transconductance voltage error amplifier output. For fixed voltage versions, the error amplifier reference voltage is internally set to program the converter output voltage. For the adjustable output, the error amplifier reference is fixed at 0.6V.

### Soft Start / Enable

Soft start limits the current surge seen at the input and eliminates output voltage overshoot. When pulled low, the enable input forces the AAT2550 into a low-power, non-switching state. The total input current during shutdown is less than 1μA.

### Current Limit and Over-Temperature Protection

For overload conditions, the peak input current is limited. To minimize power dissipation and stresses under current limit and short-circuit conditions, switching is terminated after entering current limit for a series of pulses. Switching is terminated for seven consecutive clock cycles after a current limit has been sensed for a series of four consecutive clock cycles.

Thermal protection completely disables switching when internal dissipation becomes excessive. The junction over-temperature threshold is 140°C with 15°C of hysteresis. Once an over-temperature or over-current fault conditions is removed, the output voltage automatically recovers.

### Under-Voltage Lockout

Internal bias of all circuits is controlled via the VIN input. Under-voltage lockout (UVLO) guarantees sufficient  $V_{IN}$  bias and proper operation of all internal circuitry prior to activation.



Configuration	Output Voltage	Inductor
0.6V Adjustable With External Feedback	1V, 1.2V	2.2μH
	1.5V, 1.8V	4.7μH
	2.5V, 3.3V	6.8μH
Fixed Output	0.6V to 3.3V	4.7μH

**Table 5: Inductor Values.**

## Step-Down Converter Applications Information

### Inductor Selection

The step-down converter uses peak current mode control with slope compensation to maintain stability for duty cycles greater than 50%. The output inductor value must be selected so the inductor current down slope meets the internal slope compensation requirements. The internal slope compensation for the adjustable and low-voltage fixed versions of the AAT2550 is 0.24A/μsec. This equates to a slope compensation that is 75% of the inductor current down slope for a 1.5V output and 4.7μH inductor.

$$m = \frac{0.75 \cdot V_o}{L} = \frac{0.75 \cdot 1.5V}{4.7\mu H} = 0.24 \frac{A}{\mu sec}$$

This is the internal slope compensation for the adjustable (0.6V) version or low-voltage fixed versions. When externally programming the 0.6V version to 2.5V, the calculated inductance is 7.5μH.

$$L = \frac{0.75 \cdot V_o}{m} = \frac{0.75 \cdot V_o}{0.24A \frac{A}{\mu sec}} \approx 3 \frac{\mu sec}{A} \cdot V_o$$

$$= 3 \frac{\mu sec}{A} \cdot 2.5V = 7.5\mu H$$

In this case, a standard 6.8μH value is selected.

For high-voltage fixed versions (≥2.5V), m = 0.48A/μsec. Table 5 displays inductor values for the AAT2550 fixed and adjustable options.

Manufacturer's specifications list both the inductor DC current rating, which is a thermal limitation, and the peak current rating, which is determined by the

saturation characteristics. The inductor should not show any appreciable saturation under normal load conditions. Some inductors may meet the peak and average current ratings yet result in excessive losses due to a high DCR. Always consider the losses associated with the DCR and its effect on the total converter efficiency when selecting an inductor.

The Sumida 4.7μH CDRH3D16 series inductor has a 105mΩ DCR and a 900mA DC current rating. At full load, the inductor DC loss is 38mW, which gives a 4% loss in efficiency for a 600mA, 1.5V output.

### Input Capacitor

Select a 4.7μF to 10μF X7R or X5R ceramic capacitor for the input. To estimate the required input capacitor size, determine the acceptable input ripple level (V<sub>PP</sub>) and solve for C. The calculated value varies with input voltage and is a maximum when V<sub>IN</sub> is double the output voltage.

$$C_{IN} = \frac{\frac{V_o}{V_{IN}} \cdot \left(1 - \frac{V_o}{V_{IN}}\right)}{\left(\frac{V_{PP}}{I_o} - ESR\right) \cdot F_s}$$

$$\frac{V_o}{V_{IN}} \cdot \left(1 - \frac{V_o}{V_{IN}}\right) = \frac{1}{4} \text{ for } V_{IN} = 2 \cdot V_o$$

$$C_{IN(MIN)} = \frac{1}{\left(\frac{V_{PP}}{I_o} - ESR\right) \cdot 4 \cdot F_s}$$

Always examine the ceramic capacitor DC voltage coefficient characteristics when selecting the proper value. For example, the capacitance of a 10μF, 6.3V, X5R ceramic capacitor with 5.0V DC applied is actually about 6μF.

The maximum input capacitor RMS current is:

$$I_{RMS} = I_O \cdot \sqrt{\frac{V_O}{V_{IN}} \cdot \left(1 - \frac{V_O}{V_{IN}}\right)}$$

The input capacitor RMS ripple current varies with the input and output voltage and will always be less than or equal to half of the total DC load current.

$$\sqrt{\frac{V_O}{V_{IN}} \cdot \left(1 - \frac{V_O}{V_{IN}}\right)} = \sqrt{D \cdot (1 - D)} = \sqrt{0.5^2} = \frac{1}{2}$$

for  $V_{IN} = 2 \cdot V_O$

$$I_{RMS(MAX)} = \frac{I_O}{2}$$

The term  $\frac{V_O}{V_{IN}} \cdot \left(1 - \frac{V_O}{V_{IN}}\right)$  appears in both the input voltage ripple and input capacitor RMS current equations and is a maximum when  $V_O$  is twice  $V_{IN}$ . This is why the input voltage ripple and the input capacitor RMS current ripple are a maximum at 50% duty cycle.

The input capacitor provides a low impedance loop for the edges of pulsed current drawn by the AAT2550. Low ESR/ESL X7R and X5R ceramic capacitors are ideal for this function. To minimize stray inductance, the capacitor should be placed as closely as possible to the IC. This keeps the high frequency content of the input current localized, minimizing EMI and input voltage ripple.

Proper placement of the input capacitors (C4 and C5) can be seen in the evaluation board schematic in Figure 4.

A laboratory test set-up typically consists of two long wires running from the bench power supply to the evaluation board input voltage pins. The inductance of these wires, along with the low-ESR ceramic input capacitor, can create a high Q network that may affect converter performance. This problem often becomes apparent in the form of excessive ringing in the output voltage during load transients. Errors in the loop phase and gain measurements can also result.

Since the inductance of a short PCB trace feeding the input voltage is significantly lower than the power leads from the bench power supply, most applications do not exhibit this problem.

In applications where the input power source lead inductance cannot be reduced to a level that does not affect the converter performance, a high ESR tantalum or aluminum electrolytic input capacitor should be placed in parallel with the low ESR bypass ceramic input capacitor (C6 of Figure 4). This dampens the high Q network and stabilizes the system.

### Output Capacitor

The output capacitor limits the output ripple and provides holdup during large load transitions. A 4.7μF to 10μF X5R or X7R ceramic capacitor typically provides sufficient bulk capacitance to stabilize the output during large load transitions and has the ESR and ESL characteristics necessary for low output ripple.

The output voltage droop due to a load transient is dominated by the capacitance of the ceramic output capacitor. During a step increase in load current, the ceramic output capacitor alone supplies the load current until the loop responds. Within two or three switching cycles, the loop responds and the inductor current increases to match the load current demand. The relationship of the output voltage droop during the three switching cycles to the output capacitance can be estimated by:

$$C_{OUT} = \frac{3 \cdot \Delta I_{LOAD}}{V_{DROOP} \cdot F_S}$$

Once the average inductor current increases to the DC load level, the output voltage recovers. The above equation establishes a limit on the minimum value for the output capacitor with respect to load transients.

The internal voltage loop compensation also limits the minimum output capacitor value to 4.7μF. This is due to its effect on the loop crossover frequency (bandwidth), phase margin, and gain margin. Increased output capacitance will reduce the crossover frequency with greater phase margin.



The maximum output capacitor RMS ripple current is given by:

$$I_{RMS(MAX)} = \frac{1}{2 \cdot \sqrt{3}} \cdot \frac{V_{OUT} \cdot (V_{IN(MAX)} - V_{OUT})}{L \cdot F_S \cdot V_{IN(MAX)}}$$

Dissipation due to the RMS current in the ceramic output capacitor ESR is typically minimal, resulting in less than a few degrees rise in hot-spot temperature.

### Adjustable Output Resistor Selection

For applications requiring an adjustable output voltage, the 0.6V version can be externally programmed. Resistors R7 through R10 of Figure 4 program the output to regulate at a voltage higher than 0.6V. To limit the bias current required for the external feedback resistor string while maintaining good noise immunity, the minimum suggested value for R7 and R9 is 59kΩ. Although a larger value will further reduce quiescent current, it will also increase the impedance of the feedback node, making it more sensitive to external noise and interference. Table 6 summarizes the resistor values for various output voltages with R7 and R9 set to either 59kΩ for good noise immunity or 221kΩ for reduced no load input current.

V <sub>OUT</sub> (V)	R7, R9 = 59kΩ	R7, R9 = 221kΩ
	R8, R10 (kΩ)	R8, R10 (kΩ)
0.8	19.6	75
0.9	29.4	113
1.0	39.2	150
1.1	49.9	187
1.2	59.0	221
1.3	68.1	261
1.4	78.7	301
1.5	88.7	332
1.8	118	442
1.85	124	464
2.0	137	523
2.5	187	715
3.3	267	1000

**Table 6: Adjustable Resistor Values for Use With 0.6V Step-Down Converter.**

$$R8 = \left( \frac{V_{OUT}}{V_{REF}} - 1 \right) \cdot R7 = \left( \frac{1.5V}{0.6V} - 1 \right) \cdot 59k\Omega = 88.5k\Omega$$

The adjustable version of the AAT2550, combined with an external feedforward capacitor (C10 and C11 in Figure 4), delivers enhanced transient response for extreme pulsed load applications. The addition of the feedforward capacitor typically requires a larger output capacitor for stability.

### Thermal Considerations

The AAT2550 is available in a 4x4mm QFN package, which has a typical thermal resistance of 28°C/W when the exposed paddle is soldered to a printed circuit board (PCB) in the manner discussed in the Printed Circuit Board Layout section of this datasheet. Thermal resistance will vary with the PCB area, ground plane area, size and number of other adjacent components, and the heat they generate. The maximum ambient operating temperature is limited by either the design derating criteria, the over-temperature shutdown temperature, or the thermal loop charge current reduction control. To calculate the junction temperature, sum the step-down converter losses with the battery charger losses. Multiply the total losses by the package thermal resistance and add to the ambient temperature to determine the junction temperature rise.

$$T_{J(MAX)} = (P_{SD} + P_C) \cdot \theta_{JA} + T_{AMB}$$

P<sub>SD</sub> is the total loss associated with both step-down converters and P<sub>C</sub> is the loss associated with the charger. The total losses will vary considerably depending on input voltage, load, and charging current. While charging a battery, the current capability of the step-down converters is limited.

### Step-Down Converter Losses

There are three types of losses associated with the AAT2550 step-down converter: switching losses

$(t_{SW} \cdot F_S)$ , conduction losses  $(I^2 \cdot R_{DS(ON)})$ , and quiescent current losses  $(I_Q \cdot V_{IN})$ . At full load, assuming continuous conduction mode, a simplified form of the step-down converter losses is:

$$P_{SD} = \frac{I_{OA}^2 \cdot (R_{DS(ON)H} \cdot V_{OA} + R_{DS(ON)L} \cdot (V_{IN} - V_{OA})) + I_{OB}^2 \cdot (R_{DS(ON)H} \cdot V_{OB} + R_{DS(ON)L} \cdot (V_{IN} - V_{OB}))}{V_{IN}} + (t_{SW} \cdot F_S \cdot (I_{OA} + I_{OB}) + 2 \cdot I_Q) \cdot V_{IN}$$

For the condition where one channel is in dropout at 100% duty cycle ( $I_{OA}$ ), the step-down converter dissipation is:

$$P_{SD} = I_{OA}^2 \cdot R_{DS(ON)H} + \frac{I_{OB}^2 \cdot (R_{DS(ON)H} \cdot V_{OB} + R_{DS(ON)L} \cdot (V_{IN} - V_{OB}))}{V_{IN}} + (t_{SW} \cdot F_S \cdot I_{OB} + 2 \cdot I_Q) \cdot V_{IN}$$

- $P_{SD}$  = Step-Down Converter Dissipation
- $V_{IN}$  = Converter Input Voltage
- $R_{DS(ON)H}$  = High Side MOSFET On Resistance
- $R_{DS(ON)L}$  = Low Side MOSFET On Resistance
- $V_{OA}$  = Converter A Output Voltage
- $V_{OB}$  = Converter B Output Voltage
- $I_{OA}$  = Converter A Load Current
- $I_{OB}$  = Converter B Load Current
- $I_Q$  = Converter Quiescent Current
- $t_{SW}$  = Switching Time Estimate
- $F_S$  = Converter Switching Frequency

Always use the  $R_{DS(ON)}$  and quiescent current value that corresponds to the applied input voltage.

### Battery Charger Losses

The maximum battery charger loss is:

$$P_C = (V_{ADP} - V_{MIN}) \cdot I_{CH} + V_{ADP} \cdot I_{QC}$$

- $P_C$  = Total Charger Dissipation
- $V_{ADP}$  = Adapter Voltage
- $V_{MIN}$  = Preconditioning Voltage Threshold
- $I_{CH}$  = Programmed Charge Current
- $I_{QC}$  = Charger Quiescent Current Consumed by the Charger

For an application where no load is applied to the step-down converters and the charger current is set to 1A with  $V_{ADP} = 5.0V$ , the maximum charger dissipation occurs at the preconditioning voltage threshold  $V_{MIN}$ .

$$P_C = (V_{ADP} - V_{MIN}) \cdot I_{CH} + V_{ADP} \cdot I_{QC} = (5.0V - 3.0V) \cdot 1A + 5.0V \cdot 0.74mA = 2W$$

The charger thermal loop begins reducing the charge current at a 110°C junction temperature ( $T_{LOOP\_IN}$ ). The ambient temperature at which the charger thermal loop begins reducing the charge current is:

$$T_A = T_{LOOP\_IN} - \theta_{JA} \cdot P_C = 110^\circ C - (28^\circ C/W) \cdot 2W = 54^\circ C$$

Therefore, under the given conditions, the AAT2550 battery charger will enter the thermal loop charge current reduction at an ambient temperature greater than 54°C.

### Total Power Loss Examples

The most likely high power scenario is when the charger and step-down converter are both operational and powered from the adapter. To examine the step-down converter maximum current capability for this condition, it is necessary to determine the step-down converter MOSFET  $R_{DS(ON)}$ , quiescent current, and switching losses at the adapter voltage level (5V). This example shows that with a 600mA battery charge current, the buck converter output current capability is limited 400mA. This limits the junction temperature to 110°C and avoids the thermal loop charge reduction at a 70°C ambient temperature.

#### Conditions:

$V_{OA}$	2.5V @ 400mA	Step-Down Converter A
$V_{OB}$	1.8V @ 400mA	Step-Down Converter B
$I_Q$	70µA	Converter Quiescent Current
$V_{IN} = V_{ADP}$	5.0V	Charger and Step-Down Converter Input Voltage
$V_{MIN}$	3.0V	Battery Preconditioning Threshold Voltage
$I_{CH}$	0.6A	Battery Charge Current
$I_{OP}$	0.75mA	Charger Operating Current

$$P_{TOTAL} = \frac{I_{OA}^2 \cdot (R_{DS(ON)H} \cdot V_{OA} + R_{DS(ON)L} \cdot (V_{IN} - V_{OA})) + I_{OB}^2 \cdot (R_{DS(ON)H} \cdot V_{OB} + R_{DS(ON)L} \cdot (V_{IN} - V_{OB}))}{V_{IN}} + (t_{SW} \cdot F_S \cdot (I_{OA} + I_{OB}) + 2 \cdot I_Q) \cdot V_{IN} + (V_{ADP} - V_{MIN}) \cdot I_{CH} + V_{ADP} \cdot I_{OP}$$

$$= \frac{0.4A^2 \cdot (0.475\Omega \cdot 2.5V + 0.45\Omega \cdot (5.0V - 2.5V)) + 0.4A^2 \cdot (0.475\Omega \cdot 1.8V + 0.45\Omega \cdot (5.0V - 1.8V))}{5.0V} + 2 \cdot (5ns \cdot 1.4MHz \cdot 0.4A + 70\mu A) \cdot 5.0V + (5.0V - 3.0V) \cdot 0.6A + 5.0V \cdot 0.75mA = 1.38W$$

$$T_{J(MAX)} = T_{AMB} + \theta_{JA} \cdot P_{LOSS}$$

$$= 70^\circ C + (28^\circ C/W) \cdot 1.38W$$

$$= 108^\circ C$$

The step-down converter load current capability is greatest when the battery charger is disabled. The following example demonstrates the junction temperature rise for conditions where the battery charger is disabled and full load is applied to both converter outputs at the nominal battery input voltage.

#### Conditions:

$V_{O1}$	2.5V @ 600mA	Step-Down Converter A
$V_{O2}$	1.8V @ 600mA	Step-Down Converter B
$I_Q$	70µA	Converter Quiescent Current
$V_{IN}$	3.6V	Charger and Step-Down Converter Input Voltage
$I_{CH} = I_{OP}$	0A	Charger Disabled

$$\begin{aligned}
 P_{\text{TOTAL}} &= \frac{I_{\text{OA}}^2 \cdot (R_{\text{DS(ON)H}} \cdot V_{\text{OA}} + R_{\text{DS(ON)L}} \cdot (V_{\text{IN}} - V_{\text{OA}})) + I_{\text{OB}}^2 \cdot (R_{\text{DS(ON)H}} \cdot V_{\text{OB}} + R_{\text{DS(ON)L}} \cdot (V_{\text{IN}} - V_{\text{OB}}))}{V_{\text{IN}}} \\
 &+ (t_{\text{SW}} \cdot F_{\text{S}} \cdot (I_{\text{OA}} + I_{\text{OB}}) + 2 \cdot I_{\text{Q}}) \cdot V_{\text{IN}} + (V_{\text{ADP}} - V_{\text{MIN}}) \cdot I_{\text{CH}} + V_{\text{ADP}} \cdot I_{\text{OP}} \\
 &= \frac{0.6\text{A}^2 \cdot (0.58\Omega \cdot 2.5\text{V} + 0.56\Omega \cdot (3.6\text{V} - 2.5\text{V})) + 0.2\text{A}^2 \cdot (0.58\Omega \cdot 1.8\text{V} + 0.56\Omega \cdot (3.6\text{V} - 1.8\text{V}))}{3.6\text{V}} \\
 &+ 2 \cdot (5\text{ns} \cdot 1.4\text{MHz} \cdot 0.4\text{A} + 70\mu\text{A}) \cdot 3.6\text{V} = 0.443\text{W}
 \end{aligned}$$

$$\begin{aligned}
 T_{\text{J(MAX)}} &= T_{\text{AMB}} + \theta_{\text{JA}} \cdot P_{\text{LOSS}} \\
 &= 85^\circ\text{C} + (28^\circ\text{C/W}) \cdot 0.443\text{W} \\
 &= 97^\circ\text{C}
 \end{aligned}$$

### Printed Circuit Board Layout

Use the following guidelines to ensure a proper printed circuit board layout.

1. Step-down converter bypass capacitors (C4 and C5 in Figure 4) must be placed as close as possible to the step-down converter inputs.
2. The connections from the LXA and LXB pins of the step-down converters to the output inductors should be kept as short as possible. This is a switching node, so minimizing the length will reduce the potential of this noisy trace interfering with other high impedance noise sensitive nodes.
3. The feedback trace should be separate from any power trace and connected as closely as possible to the load point. Sensing along a high current load trace will degrade the DC load regulation. If external feedback resistors are used, they should be placed as closely as possible to the FB pin. This prevents noise from being coupled into the high impedance feedback node.
4. The resistance of the trace from the load return to GND should be kept to a minimum. This minimizes any error in DC regulation due to differences in the potential of the internal signal ground and the power ground.
5. For good thermal coupling, vias are required from the pad for the QFN paddle to the ground plane. Via diameters should be 0.3mm to 0.33mm and positioned on a 1.2mm grid. Avoid close placement to other heat generating devices.
6. Minimize the trace impedance from the battery to the BAT pin. The charger output is not remotely sensed, so any drop in the output across the BAT output trace feeding the battery will add to the error in the EOC battery voltage. To minimize voltage drops on the PCB, maintain an adequate high current carrying trace width.

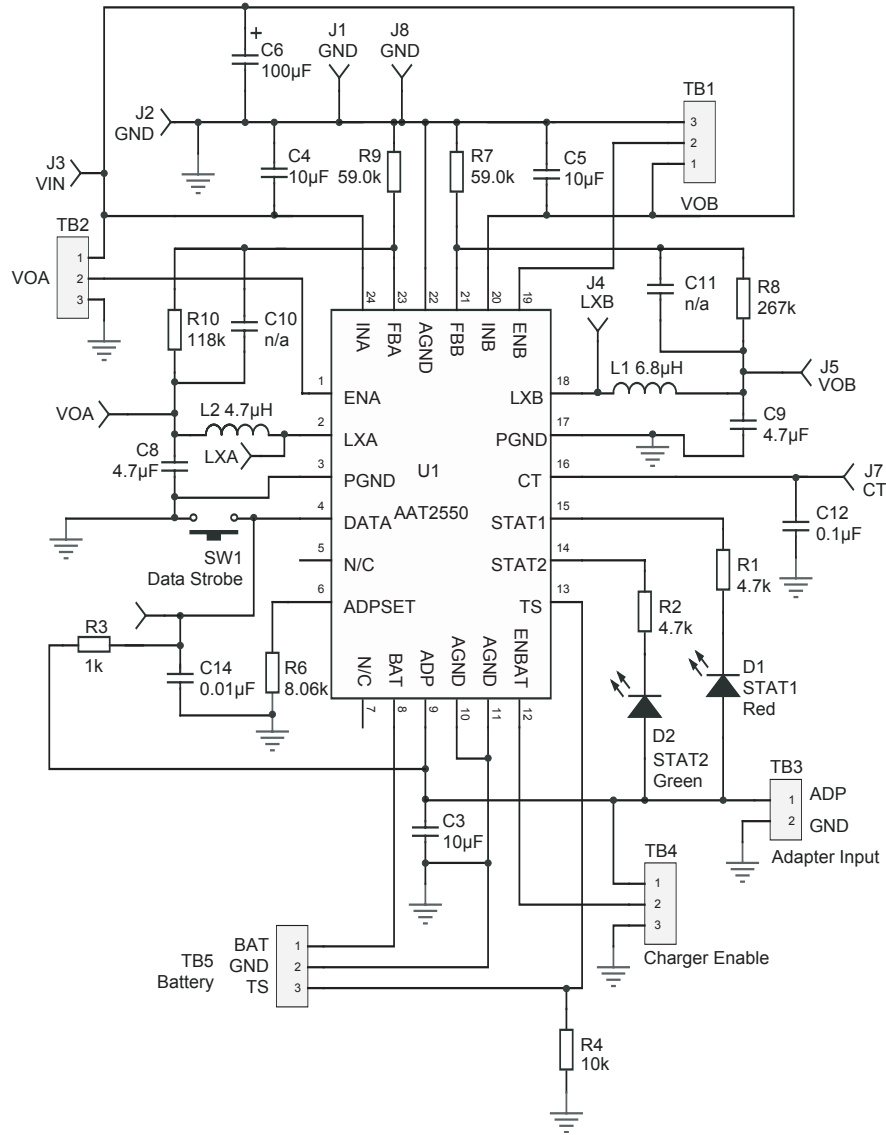

**Figure 4: AAT2550 Evaluation Board Schematic.**

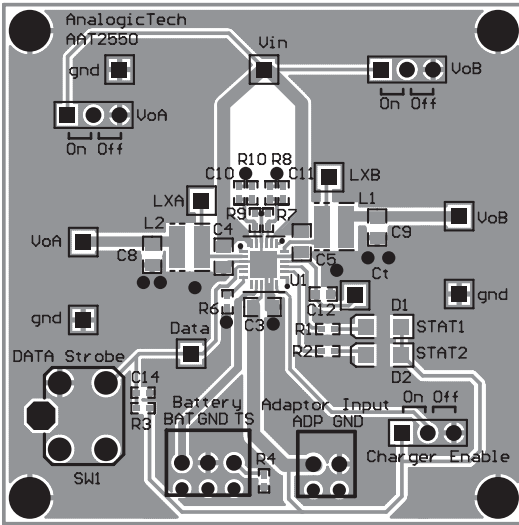

**Figure 5: AAT2550 Evaluation Board Top Side Layout.**

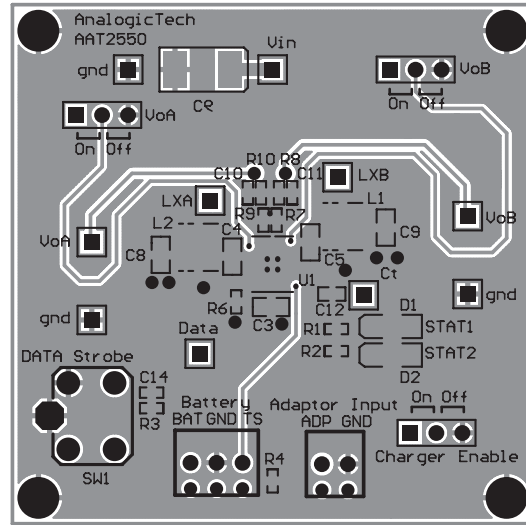

**Figure 6: AAT2550 Evaluation Board Bottom Side Layout.**

Qty.	Description	Reference Designator	Manufacturer	Part Number
1	Conn. Term Block 2.54mm 2 POS	Adapter Input	Phoenix Contact	
1	Conn. Term Block 2.54mm 3 POS	Battery Output	Phoenix Contact	
3	Ceramic Capacitor 10 $\mu$ F 10%, 10V, X5R, 0805	C3,C4,C5	Murata	
2	Ceramic Capacitor 4.7 $\mu$ F 10%, 6.3V, X5R, 0805	C8,C9	Murata	
1	Ceramic Capacitor 0.1 $\mu$ F 25V 10% X5R 0603	C12	Vishay	
1	Tantalum Capacitor 100 $\mu$ F, 6.3V, Case C	C6	Vishay	
2	Optional Ceramic Capacitor 100pF, 0402, COG	C10, C11	Vishay	
2	Ferrite Shielded Inductor CDRH3D16	L1, L2	Sumida	
2	4.7k, 5%, 1/16W, 0402	R1,R2	Vishay	
1	1.0k, 5%, 1/16W, 0402	R3	Vishay	
1	8.06k, 1%, 1/16W, 0402	R6	Vishay	
2	59.0k, 1%, 1/16W, 0402	R7,R9	Vishay	
1	1%, 1/16W, 0402	R10	Vishay	
1	1%, 1/16W, 0402	R8	Vishay	
1	10k, 5%, 1/16W, 0402	R4	Vishay	
1	Red LED, 1206	D1	Chicago Miniature Lamp	CMD15-21SRC/TR8
1	Green LED, 1206	D2	Chicago Miniature Lamp	CMD15-21SRC/TR8
1	Switch Tact 6mm SPST H = 5.0mm	SW1	ITT Industries/C&K Div	CKN9012-ND
1	AAT2550 Total Power Solution for Portable Applications	U1	Advanced Analogic Technologies	AAT2550ISK-CAA-T1

**Table 7: AAT2550 Evaluation Board Bill of Materials.**

Manufacturer	Part Number	Inductance (μH)	Max DC Current (A)	DCR (Ω)	Size (mm) LxWxH	Type
Sumida	CDRH3D16-2R2	2.2	1.20	0.072	3.8x3.8x1.8	Shielded
Sumida	CDRH3D16-4R7	4.7	0.90	0.105	3.8x3.8x1.8	Shielded
Sumida	CDRH3D16-6R8	6.8	0.73	0.170	3.8x3.8x1.8	Shielded
MuRata	LQH2MCN4R7M02	4.7	0.40	0.80	2.0x1.6x0.95	Non-Shielded
MuRata	LQH32CN4R7M23	4.7	0.45	0.20	2.5x3.2x2.0	Non-Shielded
Coilcraft	LPO3310-472	4.7	0.80	0.27	3.2x3.2x1.0	1mm
Coiltronics	SD3118-4R7	4.7	0.98	0.122	3.1x3.1x1.85	Shielded
Coiltronics	SD3118-6R8	6.8	0.82	0.175	3.1x3.1x1.85	Shielded
Coiltronics	SDRC10-4R7	4.7	1.30	0.122	5.7x4.4x1.0	1mm Shielded

**Table 8: Typical Surface Mount Inductors.**

Manufacturer	Part Number	Value	Voltage	Temp. Co.	Case
MuRata	GRM219R61A475KE19	4.7μF	10V	X5R	0805
MuRata	GRM21BR60J106KE19	10μF	6.3V	X5R	0805
MuRata	GRM21BR60J226ME39	22μF	6.3V	X5R	0805

**Table 9: Surface Mount Capacitors.**

Adjustable Version (0.6V device) V <sub>OUT</sub> (V)	R7, R9 = 59kΩ R8, R10 (kΩ)	R7, R9 = 221kΩ <sup>1</sup> R8, R10 (kΩ)	L1, L2 (μH)
0.8	19.6	75.0	2.2
0.9	29.4	113	2.2
1.0	39.2	150	2.2
1.1	49.9	187	2.2
1.2	59.0	221	2.2
1.3	68.1	261	2.2
1.4	78.7	301	4.7
1.5	88.7	332	4.7
1.8	118	442	4.7
1.85	124	464	4.7
2.0	137	523	6.8
2.5	187	715	6.8
3.3	267	1000	6.8
Fixed Version V <sub>OUT</sub> (V)	R7, R9 Not Used R8, R10 (kΩ)		L1, L2 (μH)
0.6-3.3V	0		4.7

**Table 10: Evaluation Board Component Values.**

1. For reduced quiescent current, R7 and R9 = 221kΩ.

## Step-Down Converter Design Example

### Specifications

$V_{O1} = 2.5V @ 400mA$  (adjustable using 0.6V version), pulsed load  $\Delta I_{LOAD} = 300mA$

$V_{O2} = 1.8V @ 400mA$  (adjustable using 0.6V version), pulsed load  $\Delta I_{LOAD} = 300mA$

$V_{IN} = 2.7V$  to  $4.2V$  (3.6V nominal)

$F_S = 1.4MHz$

$T_{AMB} = 85^\circ C$

### 2.5V $V_{O1}$ Output Inductor

$$L1 = 3 \frac{\mu sec}{A} \cdot V_{O1} = 3 \frac{\mu sec}{A} \cdot 2.5V = 7.5\mu H \quad (\text{see Table 5})$$

For Sumida inductor CDRH3D16,  $6.8\mu H$ ,  $DCR = 170m\Omega$ .

$$\Delta I1 = \frac{V_O}{L1 \cdot F_S} \cdot \left(1 - \frac{V_{O1}}{V_{IN}}\right) = \frac{2.5V}{6.8\mu H \cdot 1.4MHz} \cdot \left(1 - \frac{2.5V}{4.2V}\right) = 106mA$$

$$I_{PK1} = I_{O1} + \frac{\Delta I1}{2} = 0.4A + 0.053A = 0.453A$$

$$P_{L1} = I_{O1}^2 \cdot DCR = 0.45^2 \cdot 170m\Omega = 0.45^2 A^2 \cdot 170m\Omega = 34mW$$

### 1.8V $V_{O2}$ Output Inductor

$$L2 = 3 \frac{\mu sec}{A} \cdot V_{O2} = 3 \frac{\mu sec}{A} \cdot 1.8V = 5.4\mu H \quad (\text{see Table 5})$$

For Sumida inductor CDRH3D16,  $4.7\mu H$ ,  $DCR = 105m\Omega$ .

$$\Delta I2 = \frac{V_{O2}}{L \cdot F_S} \cdot \left(1 - \frac{V_{O2}}{V_{IN}}\right) = \frac{1.8V}{4.7\mu H \cdot 1.4MHz} \cdot \left(1 - \frac{1.8V}{4.2V}\right) = 156mA$$

$$I_{PK2} = I_{O2} + \frac{\Delta I2}{2} = 0.4A + 0.078A = 0.48A$$

$$P_{L2} = I_{O2}^2 \cdot DCR = 0.4A^2 \cdot 105m\Omega = 17mW$$



### 2.5V Output Capacitor

$$C_{OUT} = \frac{3 \cdot \Delta I_{LOAD}}{V_{DROOP} \cdot F_S} = \frac{3 \cdot 0.3A}{0.2V \cdot 1.4MHz} = 3.2\mu F$$

$$I_{RMS(MAX)} = \frac{1}{2 \cdot \sqrt{3}} \cdot \frac{(V_{OUT}) \cdot (V_{IN(MAX)} - V_{OUT})}{L \cdot F_S \cdot V_{IN(MAX)}} = \frac{1}{2 \cdot \sqrt{3}} \cdot \frac{2.5V \cdot (4.2V - 2.5V)}{10\mu H \cdot 1.4MHz \cdot 4.2V} = 21mA_{rms}$$

$$P_{esr} = esr \cdot I_{RMS}^2 = 5m\Omega \cdot (21mA)^2 = 2.2\mu W$$

### 1.8V Output Capacitor

$$C_{OUT} = \frac{3 \cdot \Delta I_{LOAD}}{V_{DROOP} \cdot F_S} = \frac{3 \cdot 0.3A}{0.2V \cdot 1.4MHz} = 3.2\mu F$$

$$I_{RMS(MAX)} = \frac{1}{2 \cdot \sqrt{3}} \cdot \frac{(V_{OUT}) \cdot (V_{IN(MAX)} - V_{OUT})}{L \cdot F_S \cdot V_{IN(MAX)}} = \frac{1}{2 \cdot \sqrt{3}} \cdot \frac{1.8V \cdot (4.2V - 1.8V)}{4.7\mu H \cdot 1.4MHz \cdot 4.2V} = 45mA_{rms}$$

$$P_{esr} = esr \cdot I_{RMS}^2 = 5m\Omega \cdot (45mA)^2 = 10\mu W$$

### Input Capacitor

Input Ripple  $V_{PP} = 25mV$ .

$$C_{IN} = \frac{1}{\left(\frac{V_{PP}}{I_{O1} + I_{O2}} - ESR\right) \cdot 4 \cdot F_S} = \frac{1}{\left(\frac{25mV}{0.8A} - 5m\Omega\right) \cdot 4 \cdot 1.4MHz} = 6.8\mu F$$

$$I_{RMS(MAX)} = \frac{I_{O1} + I_{O2}}{2} = 0.4A_{rms}$$

$$P = esr \cdot I_{RMS}^2 = 5m\Omega \cdot (0.4A)^2 = 0.8mW$$

### Ordering Information

Package	Voltage		Marking <sup>1</sup>	Part Number (Tape and Reel) <sup>2</sup>
	Converter 1	Converter 2		
QFN44-24	0.6V	0.6V	RJXY	<b>AAT2550ISK-CAA-T1</b>



All AnalogicTech products are offered in Pb-free packaging. The term “Pb-free” means semiconductor products that are in compliance with current RoHS standards, including the requirement that lead not exceed 0.1% by weight in homogeneous materials. For more information, please visit our website at <http://www.analogictech.com/pbfree>.

Legend	
Voltage	Code
Adjustable (0.6V)	A
0.9	B
1.2	E
1.5	G
1.8	I
1.9	Y
2.5	N
2.6	O
2.7	P
2.8	Q
2.85	R
2.9	S
3.0	T
3.3	W
4.2	C

1. XYY = assembly and date code.

2. Sample stock is generally held on part numbers listed in **BOLD**.

### QFN44-24

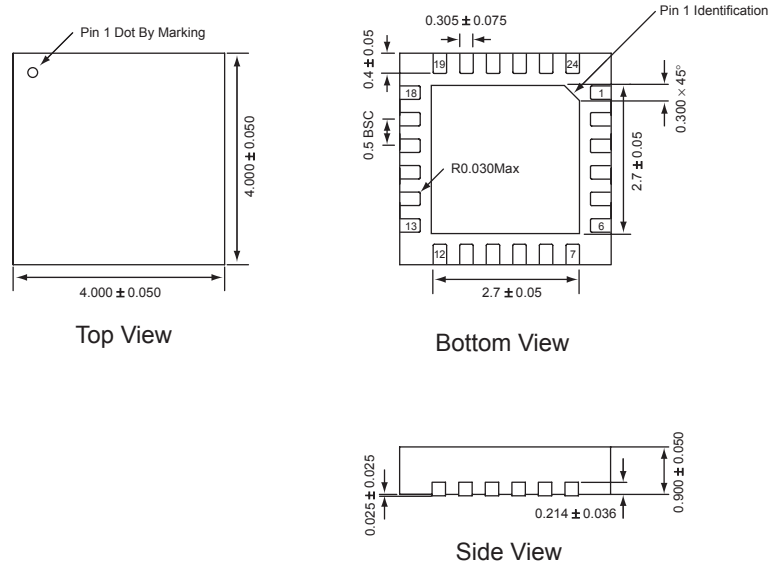

All dimensions in millimeters.

© Advanced Analogic Technologies, Inc.

AnalogicTech cannot assume responsibility for use of any circuitry other than circuitry entirely embodied in an AnalogicTech product. No circuit patent licenses, copyrights, mask work rights, or other intellectual property rights are implied. AnalogicTech reserves the right to make changes to their products or specifications or to discontinue any product or service without notice. Customers are advised to obtain the latest version of relevant information to verify, before placing orders, that information being relied on is current and complete. All products are sold subject to the terms and conditions of sale supplied at the time of order acknowledgement, including those pertaining to warranty, patent infringement, and limitation of liability. AnalogicTech warrants performance of its semiconductor products to the specifications applicable at the time of sale in accordance with AnalogicTech's standard warranty. Testing and other quality control techniques are utilized to the extent AnalogicTech deems necessary to support this warranty. Specific testing of all parameters of each device is not necessarily performed.

AnalogicTech and the AnalogicTech logo are trademarks of Advanced Analogic Technologies Incorporated. All other brand and product names appearing in this document are registered trademarks or trademarks of their respective holders.

**Advanced Analogic Technologies, Inc.**  
 830 E. Arques Avenue, Sunnyvale, CA 94085  
 Phone (408) 737-4600  
 Fax (408) 737-4611