

Dual Channel 500mA/500mA Regulator + Reset IC

Features

- Low Quiescent Current : 110 μ A (No load)
- Low Dropout Voltage :
 $V_{DROP1} = 450\text{mV @ } 500\text{mA}$
 $V_{DROP2} = 500\text{mV @ } 500\text{mA}$
- Fixed Output Voltage :
 $V_{OUT1} = 3.3\text{V}/500\text{mA}$
 $V_{OUT2} = 2.8\text{V}/500\text{mA}$
- Stable with 4.7 μ F Output Capacitor
- Stable with Aluminum, Tantalum or Ceramic Capacitors
- Built in Thermal Protection
- Fast Transient Response
- Short Setting Time
- SOP-8, SOP-8-P with Thermal Pad Packages
- Adjustment-free Reset Detection Voltage :
3.9V typ
- Easy to Set Delay Time from Voltage Detection to Reset Release
- Lead Free Available (RoHS Compliant)

General Description

The APL5551 is a dual-channel regulator with reset function (specific voltage monitoring), and internal delay circuit, set to detect 3.9V. Maximum input voltage is 6V, and both output1 and output2 can deliver up to 450mA. The typical dropout voltage of both channel is 500mV at 500mA loading. Design with an internal P-channel MOSFET pass transistor, the APL5551 maintains a low supply current. Other features include, thermal-shutdown protection, current limit protection to ensure specified output current. The APL5551 comes in miniature SOP-8 and SOP-8-P packages.

Pin Configuration

SOP-8 (Top View)

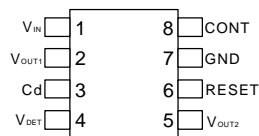

SOP-8-P (Top View)

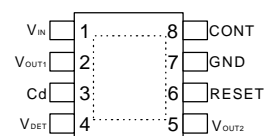

 = Thermal Pad
(connected to GND plane for better heat dissipation)

Applications

- Optical Storage System

ANPEC reserves the right to make changes to improve reliability or manufacturability without notice, and advise customers to obtain the latest version of relevant information to verify before placing orders.

Ordering and Marking Information

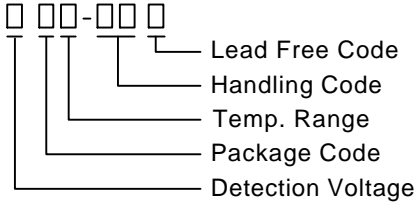
APL5551 	Package Code K : SOP-8 KA : SOP-8-P
	Temp. Range I : -40 to 85 °C Handling Code TR : Tape & Reel Lead Free Code L : Lead Free Device Blank : Original Device
APL5551 K / KA: APL5551 XXXXX	XXXXX - Date Code

Note: ANPEC lead-free products contain molding compounds/die attach materials and 100% matte tin plate termination finish; which are fully compliant with RoHS and compatible with both SnPb and lead-free soldering operations. ANPEC lead-free products meet or exceed the lead-free requirements of IPC/JEDEC J STD-020C for MSL classification at lead-free peak reflow temperature.

Pin Description

PIN		I/O	Description
No.	Name		
1	V _{IN}	I	Voltage supply input pin.
2	V _{OUT1}	O	Regulator output pin.
3	Cd	O	Delay time capacitor pin, RESET pin output delay time can be set by the capacitor connected to the Cd pin. t _{PLH} = 130000*C, t _{PLH} : transmission delay time (s), C:capacitor value (F)
4	V _{DET}	I	Input pin of voltage detection.
5	V _{OUT2}	O	Regulator output pin.
6	RESET	O	Input voltage detection output pin , high = V _{DET} <V _S , low = V _{DET} >V _S
7	GND		GND pin
8	CONT	I	V _{OUT1} on/off-control pin, V _{OUT1} will be turn off when CONT pull to low.

Absolute Maximum Ratings

Symbol	Parameter	Rating	Unit
V _{IN} , V _{OUT}	Input Voltage or Out Voltage	6.5	V
CONT	V _{OUT1} Shutdown Control Pin	6.5	V
V _{DET}	RESET Pin Supply Voltage	6.5	V
R _{TH,JA}	Thermal Resistance – Junction to Ambient		
	SOP-8	150	°C/W
	SOP-8-P	80	

Absolute Maximum Ratings (Cont.)

Symbol	Parameter	Rating	Unit
$R_{TH,JC}$	Thermal Resistance – Junction to Case		
	SOP-8	30	°C/W
SOP-8-P	5		
P_D	Power Dissipation at $T_A = 55^\circ\text{C}$ (Note)		
	SOP-8	0.7	W
SOP-8-P	1.4		
T_J	Operating Junction Temperature		
	Control Section	0 to 125	°C
Power Transistor	0 to 170		
T_{STG}	Storage Temperature Range	-65 to +150	°C
T_L	Lead Temperature (Soldering, 10 second)	260	°C

Note: When mounted on a (Copper foil area 60%, 60x45x1.6mm) glass exoxy board.

Electrical Characteristics

Unless otherwise noted these specifications apply over full temperature, $V_{IN} = 5V$, $C_{IN} = 1\mu F$, $C_{OUT1} = 4.7\mu F$, $C_{OUT2} = 4.7\mu F$, $C_{ONT} = V_{IN}$, $T_A = -40$ to 85°C . Typical values refer to $T_A = 25^\circ\text{C}$.

Symbol	Parameter	Test Conditions	APL5551			Unit
			Min.	Typ.	Max.	
V_{IN}	Input Voltage				6	V
I_Q	Quiescent Current	$I_{OUT1} = 0mA$, $I_{OUT2} = 0mA$		100	200	μA
	Shutdown Supply Current	CONT = low, $I_{OUT2} = 0mA$		70	140	μA
I_{CONT}	Shutdown Input Bias current	$V_{CONT} = V_{IN}$			0.1	μA
V_{CONT}	High Threshold Voltage		1.6		$V_{IN}+0.3$	V
	Low Threshold Voltage		-0.3		0.4	
I_{CCQ}	V_{DET} Input Current	$V_{DET} = 5V$		20	40	μA
Regulator1						
V_{OUT1}	Output Voltage	$V_{IN} = 5V$	3.234	3.3	3.366	V
I_{LIMIT}	Circuit Current Limit	$V_{IN} = 5V$		800		mA
I_{OUT}	Load Current		500			mA
REG_{LINE}	Line Regulation	$V_{OUT}+0.5V < V_{IN} < 6.0V$, $I_{OUT} = 10mA$		4	6	mV
REG_{LOAD}	Load Regulation	$V_{IN} = 5V$, $0mA < I_{OUT} < I_{MAX}$		25	60	mV

Electrical Characteristics (Cont.)

Unless otherwise noted these specifications apply over full temperature , $V_{IN} = 5V$, $C_{IN} = 1\mu F$, $C_{OUT1} = 4.7\mu F$, $C_{OUT2} = 4.7\mu F$, $C_{ONT} = V_{IN}$, $T_A = -40$ to $85^\circ C$. Typical values refer to $T_A = 25^\circ C$.

Symbol	Parameter	Test Conditions	APL5551			Unit
			Min.	Typ.	Max.	
V_{DROP}	Dropout Voltage ^(Note) (V_{OUT} (Nominal) = 3.3V Version)	$I_{OUT} = 500mA$		450	600	mV
PSRR	Ripple Rejection	$F \leq 1kHz$, 1Vpp at $I_{OUT} = 50mA$	45	55		dB
OTS	Over Temperature Shutdown		155	170		$^\circ C$
	Over Temperature Shutdown Hysteresis	Hysteresis		15		$^\circ C$
TC	Output Voltage Temperature Coefficient	$T_a = -20 \sim 80^\circ C$		100	200	ppm/ $^\circ C$
C_{OUT}	Output Capacitor			4.7		μF
	ESR		0.01		1	Ω
Regulator2						
V_{OUT2}	Output Voltage	$V_{IN} = 5V$	2.744	2.8	2.856	V
I_{LIMIT}	Circuit Current Limit	$V_{IN} = 5V$		800		mA
I_{OUT}	Load Current		500			mA
REG_{LINE}	Line Regulation	$V_{OUT} + 0.5V < V_{IN} < 6.0V$, $I_{OUT} = 10mA$		4	6	mV
REG_{LOAD}	Load Regulation	$V_{IN} = 5V$, $0mA < I_{OUT} < I_{MAX}$		25	60	mV
V_{DROP}	Dropout Voltage ^(Note) (V_{OUT} (Nominal) = 2.8V Version)	$I_{OUT} = 500mA$		500	650	mV
PSRR	Ripple Rejection	$F \leq 1kHz$, 1Vpp at $I_{OUT} = 50mA$	45	55		dB
OTS	Over Temperature Shutdown			170		$^\circ C$
	Over Temperature Shutdown Hysteresis	Hysteresis		15		$^\circ C$
TC	Output Voltage Temperature Coefficient	$T_a = -20 \sim 80^\circ C$		100	200	ppm/ $^\circ C$
C_{OUT}	Output Capacitor			4.7		μF
	ESR		0.01		1	Ω
RESET / RESET						
VS	Detection Voltage	$V_{DET} = H \rightarrow L$	3.822	3.9	3.978	V
VS/ T	Vs Temperature Coefficient	$T_a = -20 \sim +80^\circ C$		100		ppm/ $^\circ C$
VS	Hysteresis Voltage	$V_{DET} = H \rightarrow L$	130	180	230	mV

Electrical Characteristics (Cont.)

Unless otherwise noted these specifications apply over full temperature, $V_{IN} = 5V$, $C_{IN} = 1\mu F$, $C_{OUT1} = 4.7\mu F$, $C_{OUT2} = 4.7\mu F$, $C_{ONT} = V_{IN}$, $T_A = -40$ to $85^\circ C$. Typical values refer to $T_A = 25^\circ C$.

Symbol	Parameter	Test Conditions	APL5551			Unit
			Min.	Typ.	Max.	
RESET / RESET						
V_{OL}	Low-level Output Voltage	$V_{DET} = 3.9V$, $R_L = 4.7k\Omega$		22	60	mV
I_{OH}	Output Leakage Current	$V_{DET} = 5V$		0.5	1	μA
I_{OL1}	Output Current1	$V_{DET} = 3.9V$, $V_{RESET} = 0.4V$	10	14		mA
I_{OL2}	Output Current2	$V_{DET} = 3.9V$, $V_{RESET} = 0.4V$ $T_A = -20 \sim +80^\circ C$	8	14		mA
t_{PLH}	"H" Transmission Delay Time	$C_d = 0\mu F$		42	90	μs
t_{PLH1}	Reset Delay Time	$V_{DET} = 3.7V \rightarrow 5V$, $C_d = 0.1\mu F$	8	13	18	ms
t_{PHL}	"L" Transmission Delay Time	$C_d = 0\mu F$		4	90	μs
V_{OPL}	Threshold Operating Voltage	$V_{RESET} = 0.4V$		0.95	1.25	V

Application Circuit

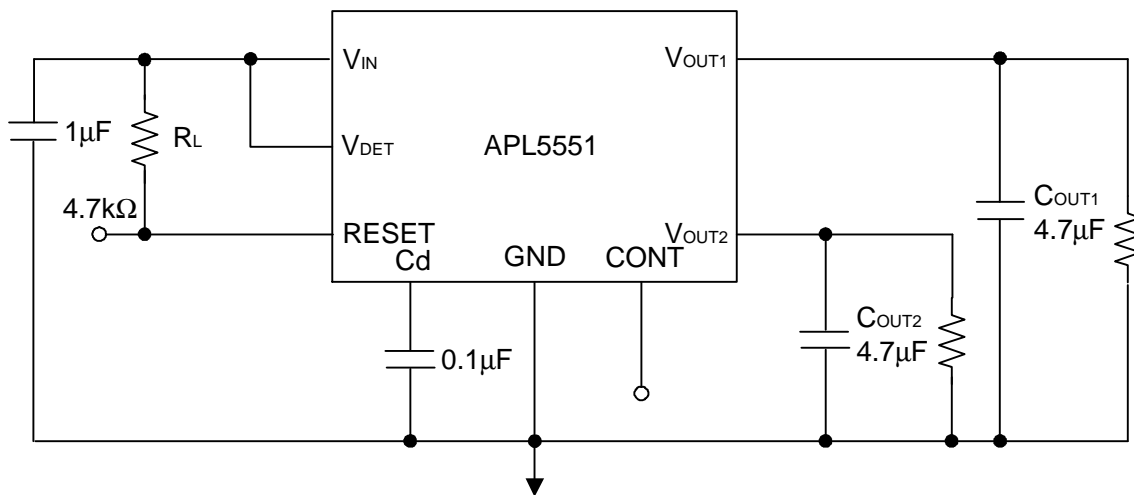

Timing Chart

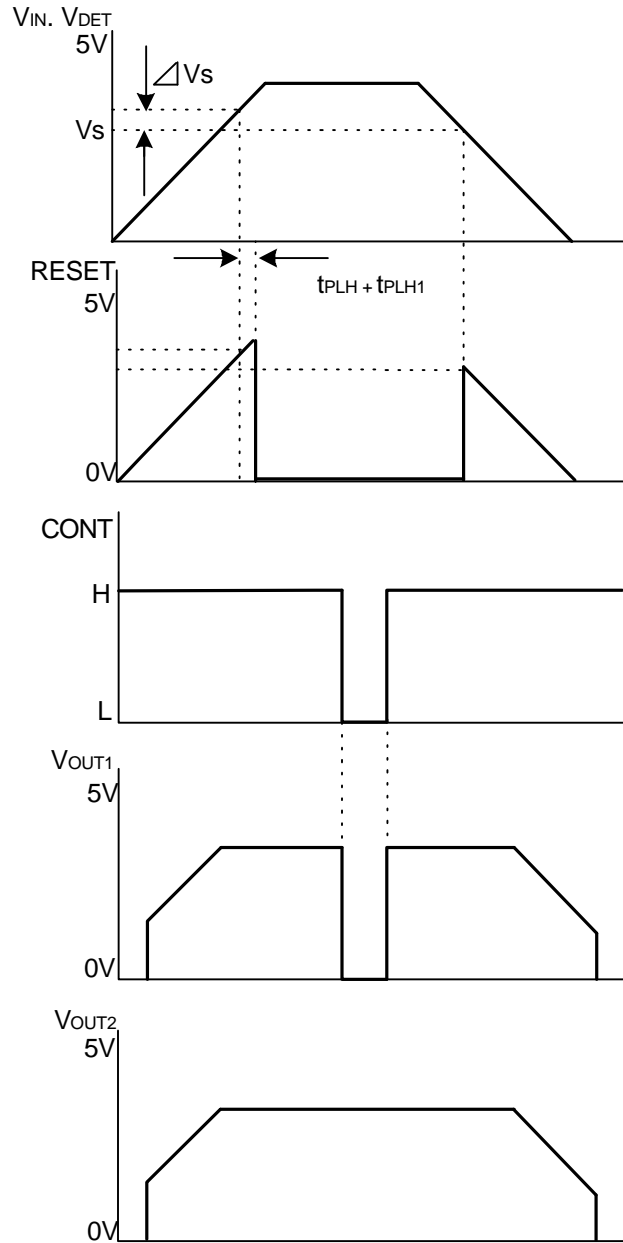

Typical Characteristics

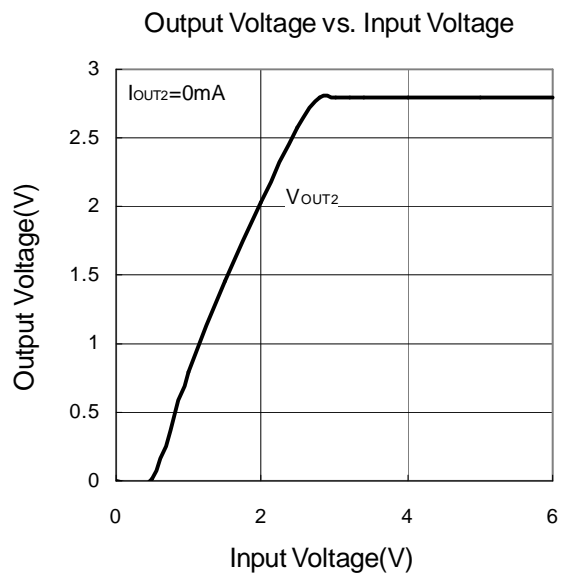
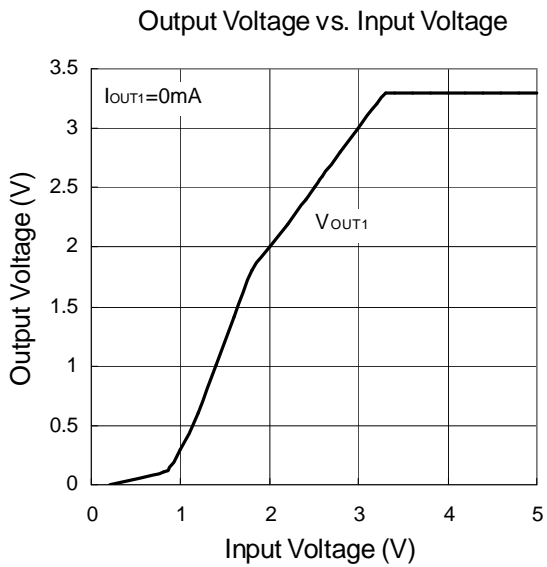
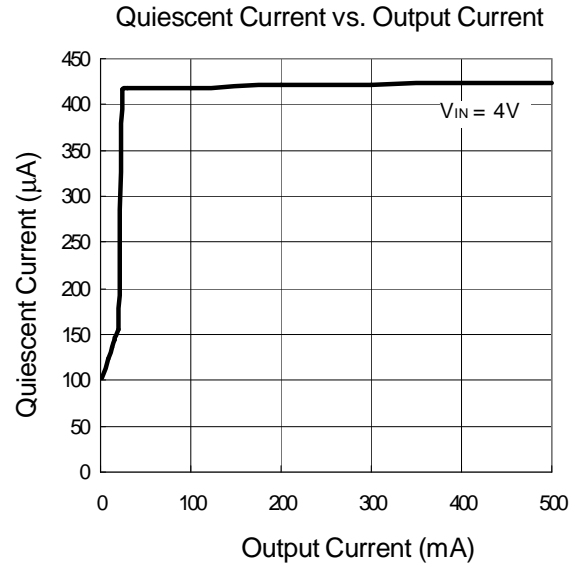
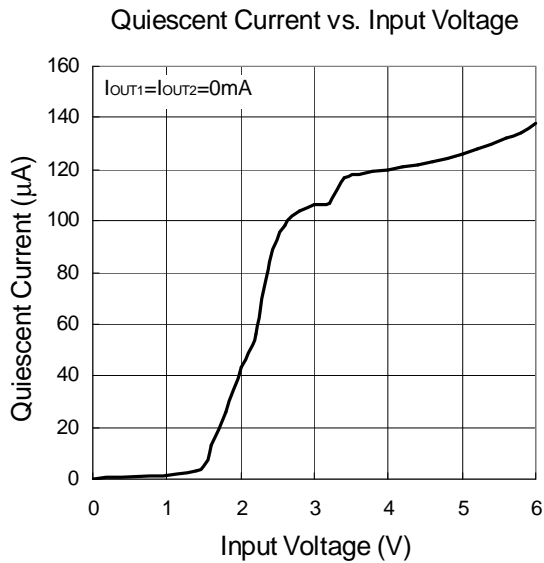

Typical Characteristics

Output Voltage vs .Temperature

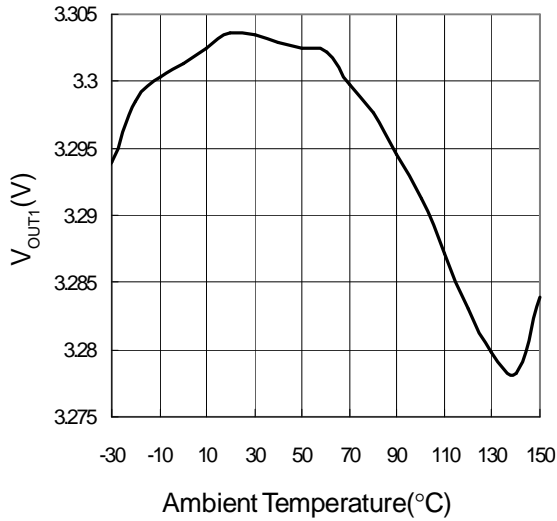

Output Voltage vs .Temperature

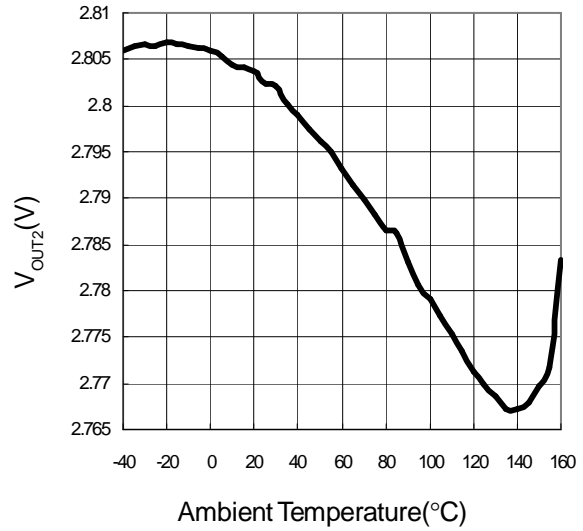

Dropout Voltage vs. Output Current

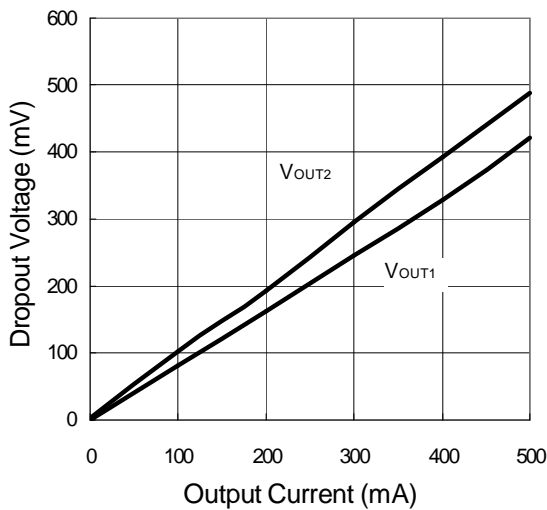

PSRR vs. Frequency

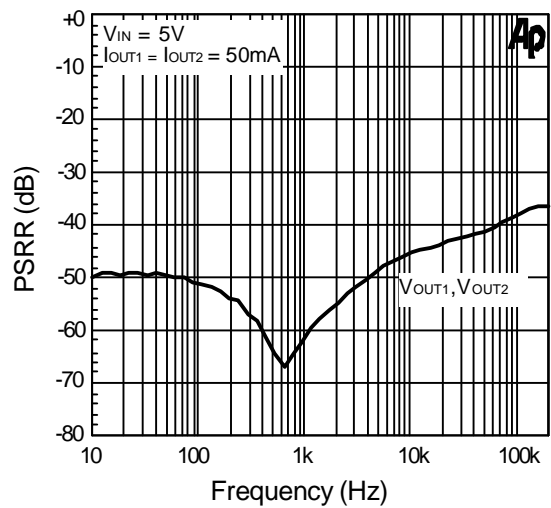

Typical Characteristics

Load-Transient Response

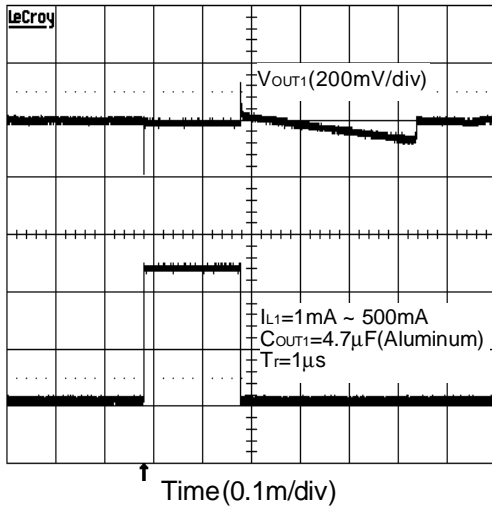

Load-Transient Response

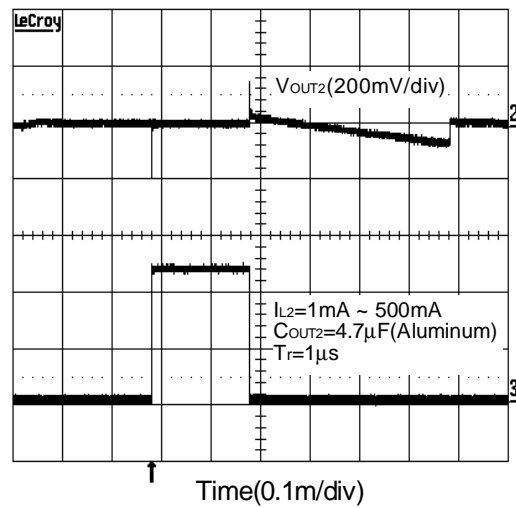

Line-Transient Response

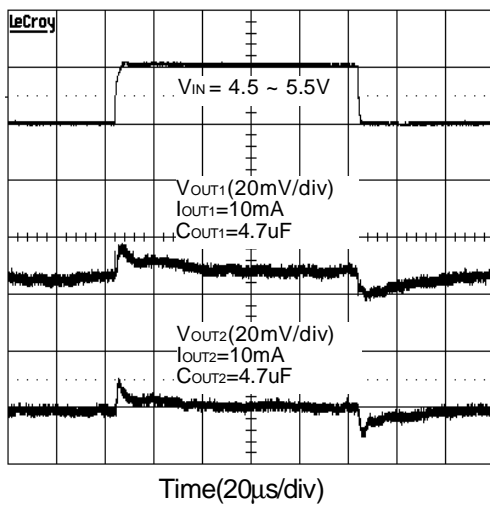

Shutdown Response

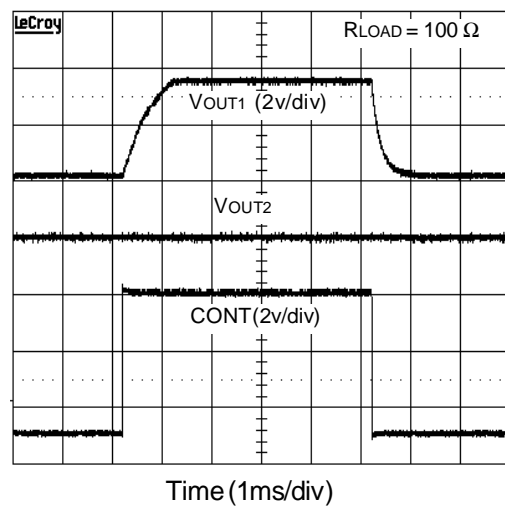

Typical Characteristics

Power Dissipation vs. Ambient Temperature

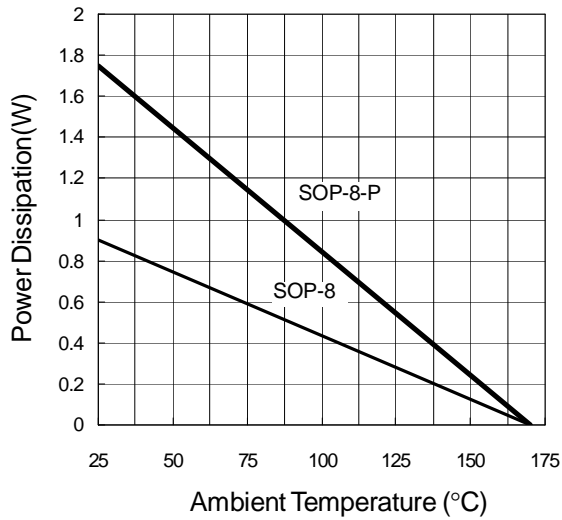

Power On

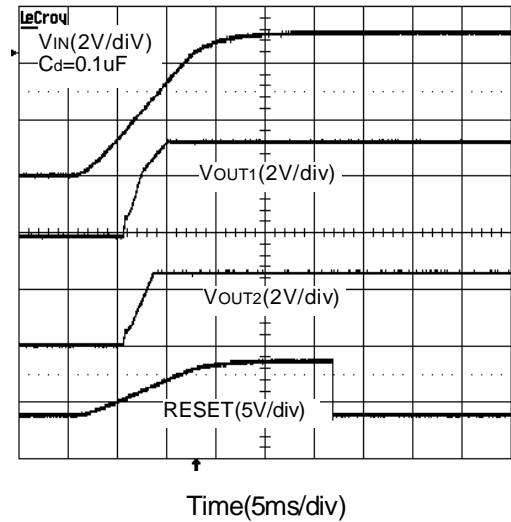

Power Off

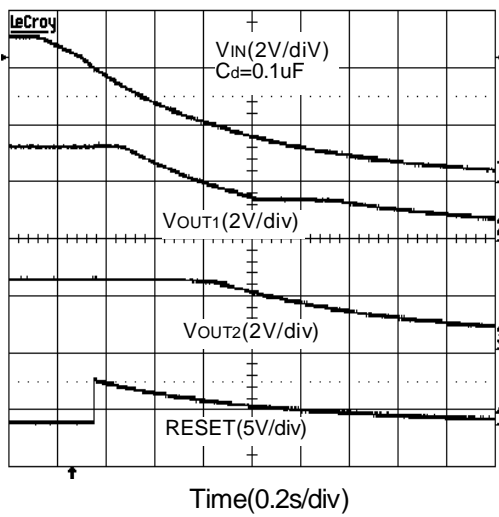

Application Information

Capacitor Selection and Regulator Stability

The APL5551 uses at least a 1 μ F capacitor on the input. This capacitor can use Aluminum, Tantalum or Ceramic capacitors. Input capacitor with large value and low ESR provides better PSRR and line-transient response. The output capacitor also can use Aluminum, Tantalum or Ceramic capacitors, and its minimum values is recommended 4.7 μ F, ESR must be above 0.01 Ω . Large output capacitor values can reduce noise and improve load-transient response, stability, and PSRR. Note that some ceramic dielectrics exhibit large capacitance and ESR variation with Temperature. If use this capacitor, it may be necessary to use 4.7 μ F or more to ensure stability at temperature below -10°C.

Load-Transient Considerations

The APL5551 load-transient response graphs in Typical Characteristics show the transient response. A step change in the load current from 1mA to 500mA at 1 μ second will cause less than 200mV transient spike. Large output capacitor's value and low ESR can reduce transient spike.

Shutdown/Enable

The APL5551 has an active high enable function. Force CONT high (>1.6V) enables the V_{OUT1} , CONT low (<0.4V) disables the V_{OUT1} and V_{OUT2} can not be affected by CONT. In shutdown mode, the quiescent current can reduce to 70 μ A. The CONT pin cannot be floating, a floating CONT pin may cause an indeterminate state on the output. If it is no use, connect to V_{IN} for normal operation.

RESET

The RESET pin is asserted whenever V_{DET} falls below the reset threshold voltage or if CONT is forced low at some special IC (refer timing chart and pin description). The reset function ensures the microprocessor is

properly reset and powers up into a known condition after a power failure. RESET will remain valid with V_{IN} as low as 0.95V. The RESET output is a simple open-drain N channel MOSFET structure. A pull-up resistor must be used to pull this output up to some voltage. For most application, this voltage will be the same power supply that supplies V_{IN} to the APL5551. The APL5551 is relatively immune to negative-going glitches below the reset threshold. Typically reset delay time is 13ms while using 0.1 μ F at Cd pin. If more transient immunity is needed, a Cd capacitor can be placed as larger as possible.

Input-Output (Dropout) Voltage

The minimum input-output voltage differential (dropout) determines the lowest usable supply voltage. The dropout voltage is a function of drain-to-source on resistance multiplied by the load current.

Current Limit

APL5551 includes two separate current-limit circuitry for each linear regulator. The current limit protection, which sense the current flows the P-channel MOSFET, and controls the output voltage. The point where limiting occurs is $I_{OUT}=800$ mA. The output can be shorted to ground for an indefinite amount of time without damaging to the part.

Thermal Protection

Thermal protection limits total power dissipation in the APL5551. When the junction temperature exceeds $T_j=+170^\circ\text{C}$, the thermal sensor generate a logic signal to turn off the pass transistor and let IC to cool. When the IC's junction temperature cools by 15°C, the thermal sensor will turn the pass transistor on again, resulting in a pulsed output during continuous thermal protection. Thermal protection is designed to protect the IC in the event of fault conditions. For continual

Application Information

Thermal Protection (Cont.)

operation, do not exceed the junction temperature rating of $T_{j, \text{max}} = +150^{\circ}\text{C}$.

Operating Region and Power Dissipation

The thermal resistance of the case and circuit board, ambient and junction air temperature, and the rate of air flow all control the APL5551 maximum power dissipation. The power dissipation across the device is $P = I_{\text{OUT}}(V_{\text{IN}} - V_{\text{OUT}})$. The maximum power dissipation is:

$$P_{\text{MAX}} = (T_{\text{J}} - T_{\text{A}}) / (\theta_{\text{JB}} + \theta_{\text{BA}})$$

where $T_{\text{J}} - T_{\text{A}}$ is the temperature difference between the junction and ambient air.

θ_{JB} is the thermal resistance of the package, θ_{BA} is the thermal resistance through the printed circuit board, copper traces, and other materials to the surrounding air. The GND pin provides an electrical connection to ground and channeling heat away. Connect the GND pin to ground using a large pad or ground plane as a heat sink, it can improve maximize thermal dissipation.

For example:

The SOP8 package has maximum power dissipation 0.7W at $T_{\text{A}} = 55^{\circ}\text{C}$ and 1.4W at SOP-8-P (see Power dissipation vs Ambient Temperature).

$$V_{\text{IN}} = 5\text{V}, I_{\text{OUT}} = 250\text{mA}, V_{\text{OUT1}} = 3.3\text{V}, V_{\text{OUT2}} = 2.8\text{V},$$

$$P_{\text{D}} = [(5-3.3)\text{V} + (5-2.8)\text{V}] \times 250\text{mA} = 0.975\text{W}$$

the $P_{\text{D}} = 0.975\text{W}$

According the power dissipation issue, we should adapt the SOP-8-P package. It could reduce the thermal resistance to maintain the IC longer life.

See figure 1. The SOP-8-P utilizes a bottom thermal pad to minimize the thermal resistance of the package, making the package suitable for high current

applications. The thermal pad is soldered to the top ground pad and is connected to the internal or bottom ground plane by several vias. The printed circuit board (PCB) forms a heat sink and dissipates most of the heat into ambient air. The vias are recommended to have proper size to retain solder, helping heat conduction.

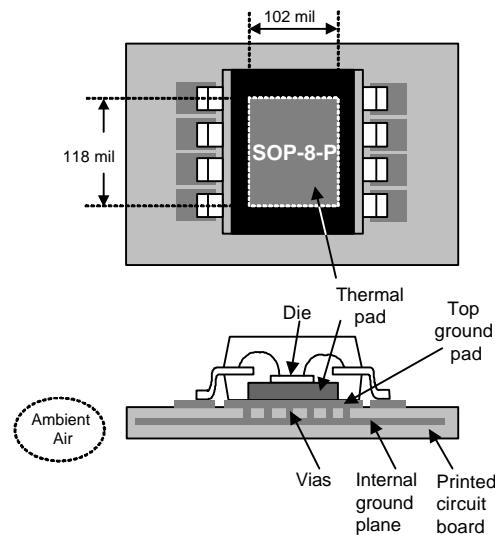
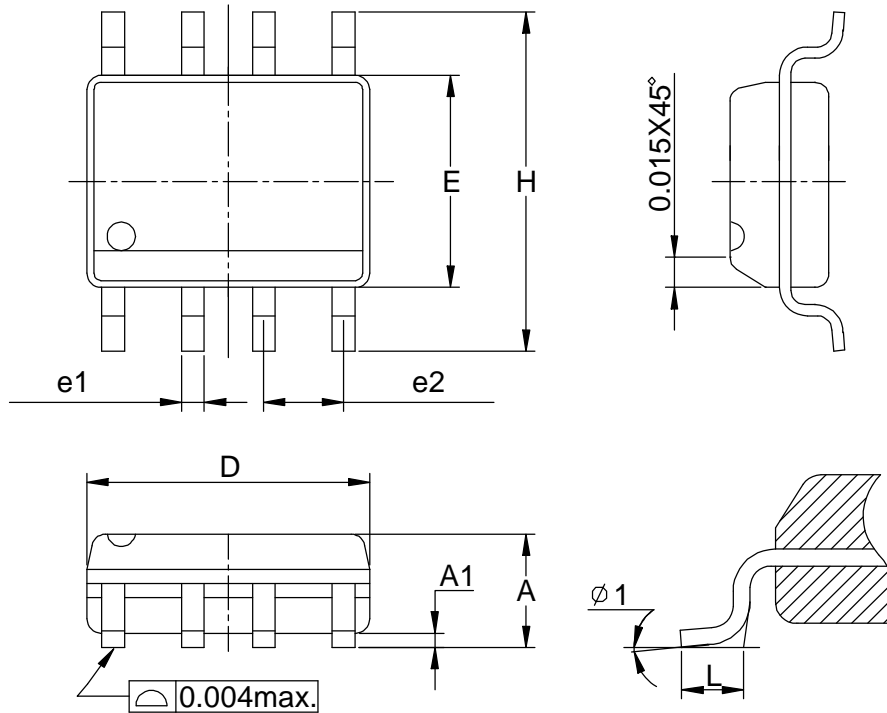

Figure 1

Packaging Information

SOP-8 pin (Reference JEDEC Registration MS-012)



Dim	Millimeters		Inches	
	Min.	Max.	Min.	Max.
A	1.35	1.75	0.053	0.069
A1	0.10	0.25	0.004	0.010
D	4.80	5.00	0.189	0.197
E	3.80	4.00	0.150	0.157
H	5.80	6.20	0.228	0.244
L	0.40	1.27	0.016	0.050
e1	0.33	0.51	0.013	0.020
e2	1.27BSC		0.50BSC	
$\phi 1$	0°	8°	0°	8°

Packaging Information

SOP-8-P pin (Reference JEDEC Registration MS-012)

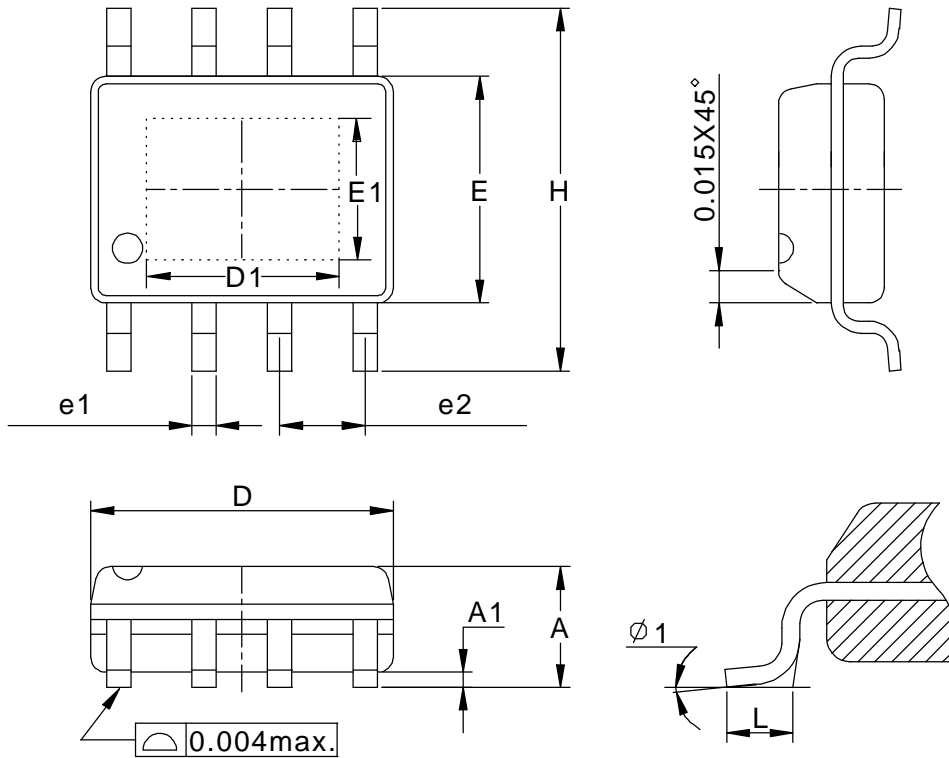

Dim	Millimeters		Inches	
	Min.	Max.	Min.	Max.
A	1.35	1.75	0.053	0.069
A1	0	0.15	0	0.006
D	4.80	5.00	0.189	0.197
D1	3.00REF		0.118REF	
E	3.80	4.00	0.150	0.157
E1	2.60REF		0.102REF	
H	5.80	6.20	0.228	0.244
L	0.40	1.27	0.016	0.050
e1	0.33	0.51	0.013	0.020
e2	1.27BSC		0.50BSC	
φ 1	8°		8°	

Physical Specifications

Terminal Material	Solder-Plated Copper (Solder Material : 90/10 or 63/37 SnPb), 100%Sn
Lead Solderability	Meets EIA Specification RSI86-91, ANSI/J-STD-002 Category 3.

Reflow Condition (IR/Convection or VPR Reflow)

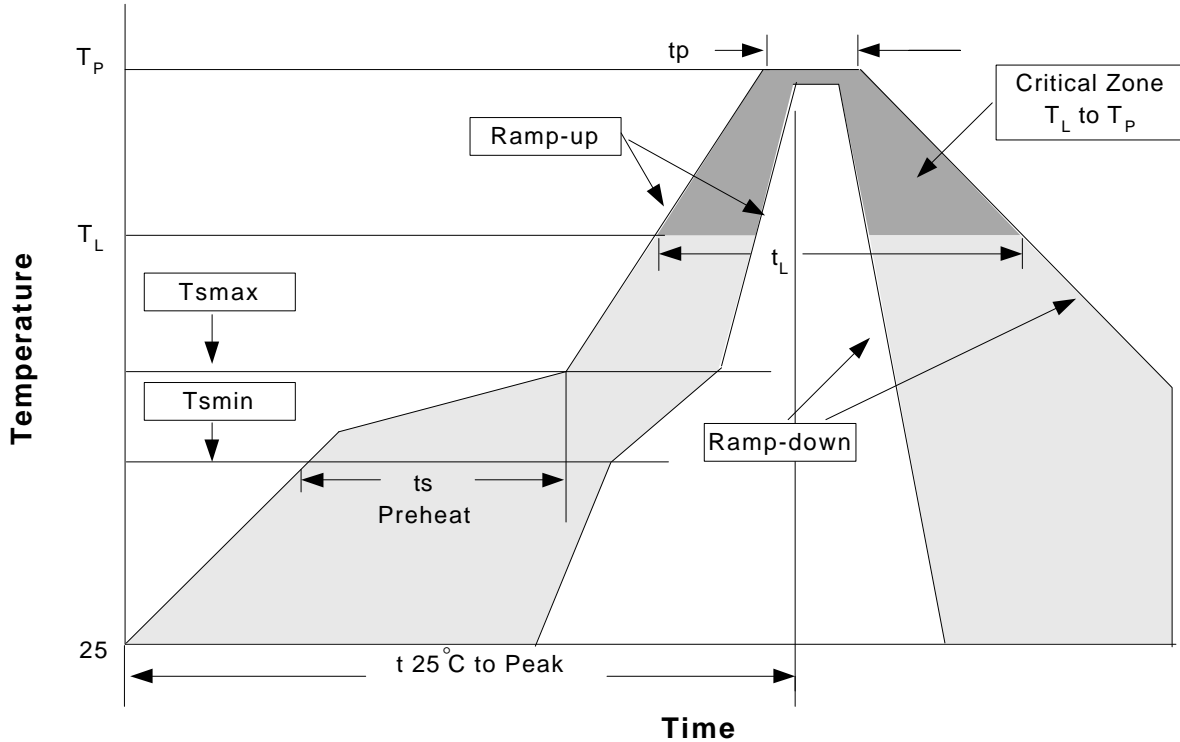

Classification Reflow Profiles

Profile Feature	Sn-Pb Eutectic Assembly	Pb-Free Assembly
Average ramp-up rate (T_L to T_P)	3°C/second max.	3°C/second max.
Preheat <ul style="list-style-type: none"> - Temperature Min (T_{smin}) - Temperature Max (T_{smax}) - Time (min to max) (t_s) 	100°C 150°C 60-120 seconds	150°C 200°C 60-180 seconds
Time maintained above: <ul style="list-style-type: none"> - Temperature (T_L) - Time (t_L) 	183°C 60-150 seconds	217°C 60-150 seconds
Peak/Classification Temperature (T_P)	See table 1	See table 2
Time within 5°C of actual Peak Temperature (t_p)	10-30 seconds	20-40 seconds
Ramp-down Rate	6°C/second max.	6°C/second max.
Time 25°C to Peak Temperature	6 minutes max.	8 minutes max.

Notes: All temperatures refer to topside of the package .Measured on the body surface.

Classification Reflow Profiles (Cont.)

Table 1. SnPb Eutectic Process – Package Peak Reflow Temperatures

Package Thickness	Volume mm ³ <350	Volume mm ³ ≥350
<2.5 mm	240 +0/-5°C	225 +0/-5°C
≥2.5 mm	225 +0/-5°C	225 +0/-5°C

Table 2. Pb-free Process – Package Classification Reflow Temperatures

Package Thickness	Volume mm ³ <350	Volume mm ³ 350-2000	Volume mm ³ >2000
<1.6 mm	260 +0°C*	260 +0°C*	260 +0°C*
1.6 mm – 2.5 mm	260 +0°C*	250 +0°C*	245 +0°C*
≥2.5 mm	250 +0°C*	245 +0°C*	245 +0°C*

*Tolerance: The device manufacturer/supplier **shall** assure process compatibility up to and including the stated classification temperature (this means Peak reflow temperature +0°C. For example 260°C+0°C) at the rated MSL level.

Reliability Test Program

Test item	Method	Description
SOLDERABILITY	MIL-STD-883D-2003	245°C, 5 SEC
HOLT	MIL-STD-883D-1005.7	1000 Hrs Bias @ 125°C
PCT	JESD-22-B,A102	168 Hrs, 100%RH, 121°C
TST	MIL-STD-883D-1011.9	-65°C~150°C, 200 Cycles
ESD	MIL-STD-883D-3015.7	VHBM > 2KV, VMM > 200V
Latch-Up	JESD 78	10ms, 1 _{tr} > 100mA

Carrier Tape

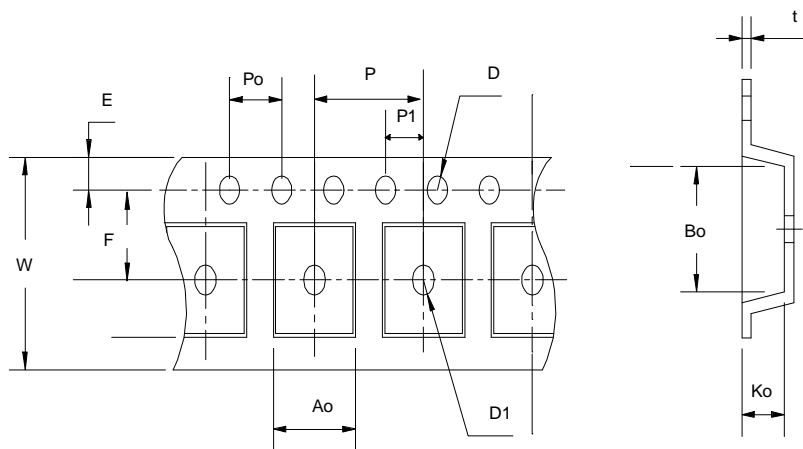

Carrier Tape (Cont.)

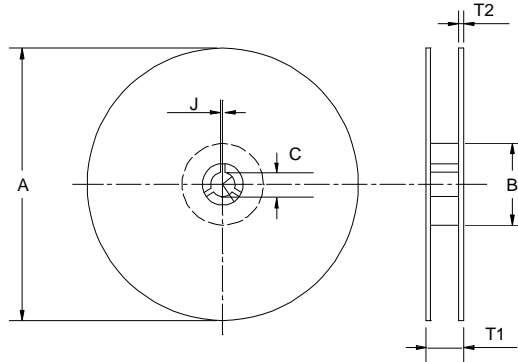

Application	A	B	C	J	T1	T2	W	P	E
SOP- 8/-P	330 ± 1	62 +1.5	12.75+ 0.15	2 ± 0.5	12.4 ± 0.2	2 ± 0.2	12± 0. 3	8± 0.1	1.75±0.1
	F	D	D1	Po	P1	Ao	Bo	Ko	t
	5.5± 1	1.55 +0.1	1.55+ 0.25	4.0 ± 0.1	2.0 ± 0.1	6.4 ± 0.1	5.2± 0. 1	2.1± 0.1	0.3±0.013

(mm)

Cover Tape Dimensions

Application	Carrier Width	Cover Tape Width	Devices Per Reel
SOP- 8/-P	12	9.3	2500

Customer Service

Anpec Electronics Corp.

Head Office :

No.6, Dusing 1st Road, SBIP,

Hsin-Chu, Taiwan, R.O.C.

Tel : 886-3-5642000

Fax : 886-3-5642050

Taipei Branch :

7F, No. 137, Lane 235, Pac Chiao Rd.,

Hsin Tien City, Taipei Hsien, Taiwan, R. O. C.

Tel : 886-2-89191368

Fax : 886-2-89191369