

Super Junction MOSFET

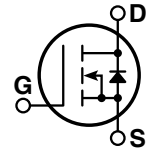

- Ultra low $R_{DS(ON)}$
- Low Miller Capacitance
- Ultra Low Gate Charge, Q_g
- Avalanche Energy Rated
- TO-220 Package

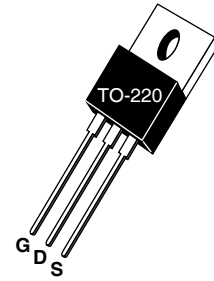

MAXIMUM RATINGS

All Ratings: $T_C = 25^\circ\text{C}$ unless otherwise specified.

Symbol	Parameter	APT11N80KC3	UNIT
V_{DSS}	Drain-Source Voltage	800	Volts
I_D	Continuous Drain Current @ $T_C = 25^\circ\text{C}$	11	Amps
I_{DM}	Pulsed Drain Current ^①	33	
V_{GS}	Gate-Source Voltage Continuous	± 20	Volts
V_{GSM}	Gate-Source Voltage Transient	± 30	
P_D	Total Power Dissipation @ $T_C = 25^\circ\text{C}$	156	Watts
	Linear Derating Factor	1.25	W/ $^\circ\text{C}$
T_J, T_{STG}	Operating and Storage Junction Temperature Range	-55 to 150	$^\circ\text{C}$
T_L	Lead Temperature: 0.063" from Case for 10 Sec.	260	
dv/dt	Drain-Source Voltage slope ($V_{DS} = 640\text{V}$, $I_D = 11\text{A}$, $T_J = 125^\circ\text{C}$)	50	V/ns
I_{AR}	Repetitive Avalanche Current ^⑦	11	Amps
E_{AR}	Repetitive Avalanche Energy ^⑦	0.2	mJ
E_{AS}	Single Pulse Avalanche Energy ^④	470	

STATIC ELECTRICAL CHARACTERISTICS

Symbol	Characteristic / Test Conditions	MIN	TYP	MAX	UNIT
BV_{DSS}	Drain-Source Breakdown Voltage ($V_{GS} = 0\text{V}$, $I_D = 250\mu\text{A}$)	800			Volts
$R_{DS(on)}$	Drain-Source On-State Resistance ^② ($V_{GS} = 10\text{V}$, $I_D = 7.1\text{A}$)		0.39	0.45	Ohms
I_{DSS}	Zero Gate Voltage Drain Current ($V_{DS} = 800$, $V_{GS} = 0\text{V}$)		0.5	20	μA
	Zero Gate Voltage Drain Current ($V_{DS} = 800$, $V_{GS} = 0\text{V}$, $T_J = 150^\circ\text{C}$)			200	
I_{GSS}	Gate-Source Leakage Current ($V_{GS} = \pm 20\text{V}$, $V_{DS} = 0\text{V}$)			± 100	nA
$V_{GS(th)}$	Gate Threshold Voltage ($V_{DS} = V_{GS}$, $I_D = 680\mu\text{A}$)	2.1	3	3.9	Volts

 **CAUTION:** These Devices are Sensitive to Electrostatic Discharge. Proper Handling Procedures Should Be Followed.

APT Website - <http://www.advancedpower.com>

"COOLMOS™" comprise a new family of transistors developed by Infineon Technologies AG. "COOLMOS" is a trademark of Infineon Technologies AG"

DYNAMIC CHARACTERISTICS

APT11N80KC3

Symbol	Characteristic	Test Conditions	MIN	TYP	MAX	UNIT
C _{iss}	Input Capacitance	V _{GS} = 0V V _{DS} = 25V f = 1 MHz		1585		pF
C _{oss}	Output Capacitance			770		
C _{rss}	Reverse Transfer Capacitance			18		
Q _g	Total Gate Charge ③	V _{GS} = 10V V _{DD} = 400V I _D = 11A @ 25°C		60		nC
Q _{gs}	Gate-Source Charge			8		
Q _{gd}	Gate-Drain ("Miller") Charge			30		
t _{d(on)}	Turn-on Delay Time	RESISTIVE SWITCHING V _{GS} = 10V V _{DD} = 400V I _D = 11A @ 25°C R _G = 7.5Ω		25		ns
t _r	Rise Time			15		
t _{d(off)}	Turn-off Delay Time			70	80	
t _f	Fall Time			7	10	
E _{on}	Turn-on Switching Energy ⑥	INDUCTIVE SWITCHING @ 25°C V _{DD} = 533V, V _{GS} = 15V I _D = 11A, R _G = 5Ω		165		μJ
E _{off}	Turn-off Switching Energy			50		
E _{on}	Turn-on Switching Energy ⑥	INDUCTIVE SWITCHING @ 125°C V _{DD} = 533V, V _{GS} = 15V I _D = 11A, R _G = 5Ω		305		
E _{off}	Turn-off Switching Energy			65		

SOURCE-DRAIN DIODE RATINGS AND CHARACTERISTICS

Symbol	Characteristic / Test Conditions	MIN	TYP	MAX	UNIT
I _S	Continuous Source Current (Body Diode)			11	Amps
I _{SM}	Pulsed Source Current ① (Body Diode)			33	
V _{SD}	Diode Forward Voltage ② (V _{GS} = 0V, I _S = -11A)		1	1.2	Volts
t _{rr}	Reverse Recovery Time (I _S = 11A, di _S /dt = -100A/μs, V _R = 640V)		550		ns
Q _{rr}	Reverse Recovery Charge (I _S = 11A, di _S /dt = -100A/μs, V _R = 640V)		10		μC
dv/dt	Peak Diode Recovery dv/dt ⑤			6	V/ns

THERMAL CHARACTERISTICS

Symbol	Characteristic	MIN	TYP	MAX	UNIT
R _{θJC}	Junction to Case			0.80	°C/W
R _{θJA}	Junction to Ambient			62	

- ① Repetitive Rating: Pulse width limited by maximum junction temperature
- ② Pulse Test: Pulse width < 380 μs, Duty Cycle < 2%
- ③ See MIL-STD-750 Method 3471
- ④ Starting T_J = +25°C, L = 194mH, R_G = 25Ω, Peak I_L = 2.2A
- ⑤ dv/dt numbers reflect the limitations of the test circuit rather than the device itself. I_S ≤ -I_D 11A di/dt ≤ 700A/μs V_R ≤ V_{DSS} T_J ≤ 150°C
- ⑥ Eon includes diode reverse recovery. See figures 18, 20.
- ⑦ Repetitive avalanche causes additional power losses that can be calculated as P_{AV} = E_{AR} * f

APT Reserves the right to change, without notice, the specifications and information contained herein.

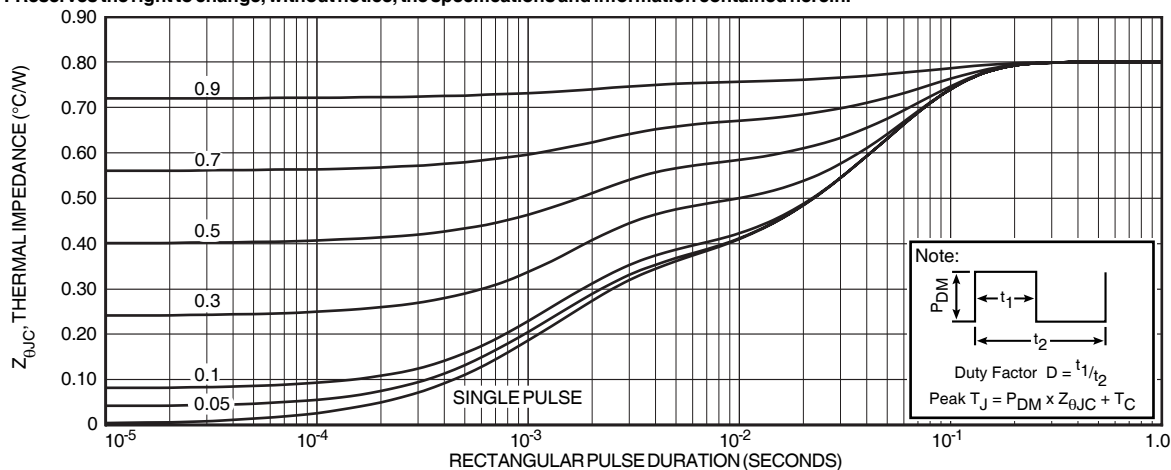

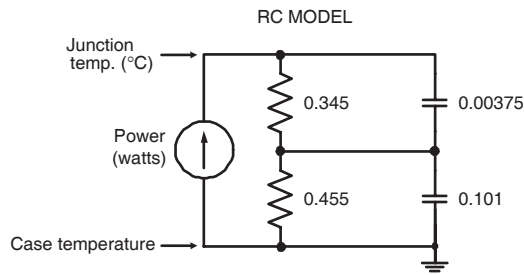

FIGURE 2, TRANSIENT THERMAL IMPEDANCE MODEL

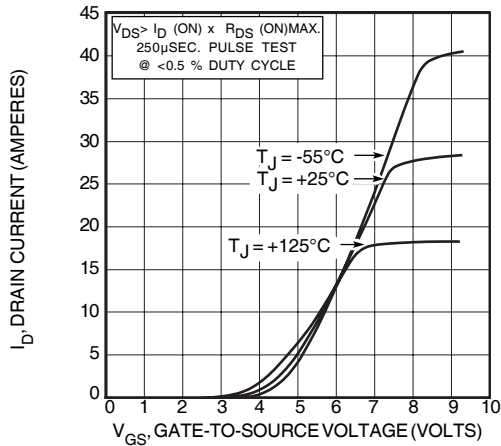

FIGURE 4, TRANSFER CHARACTERISTICS

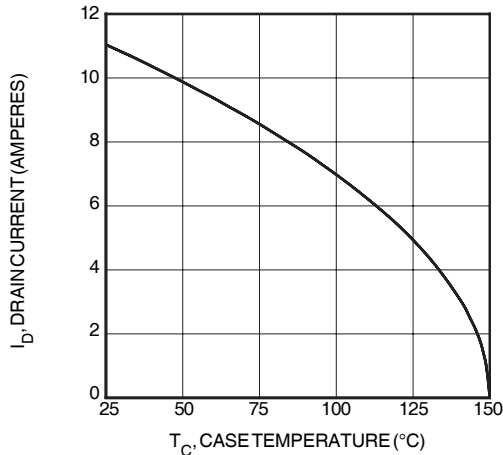

FIGURE 6, MAXIMUM DRAIN CURRENT vs CASE TEMPERATURE

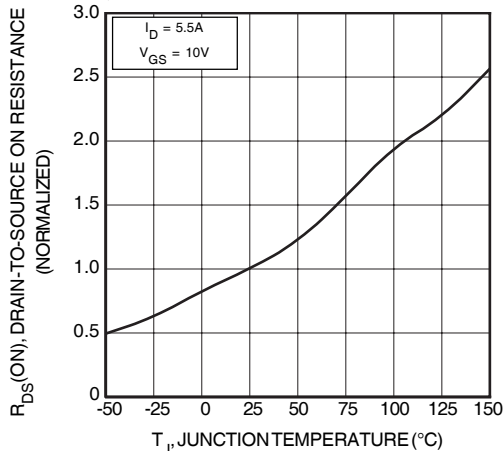

FIGURE 8, ON-RESISTANCE vs. TEMPERATURE

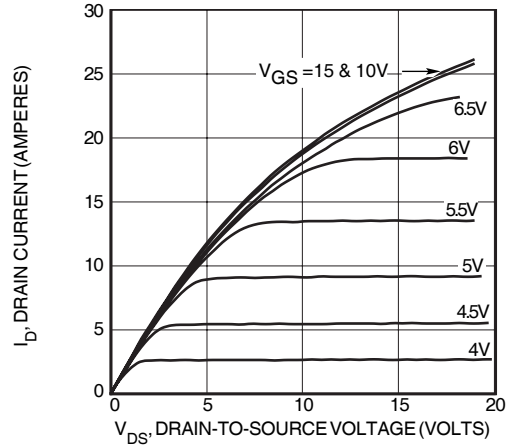

FIGURE 3, LOW VOLTAGE OUTPUT CHARACTERISTICS

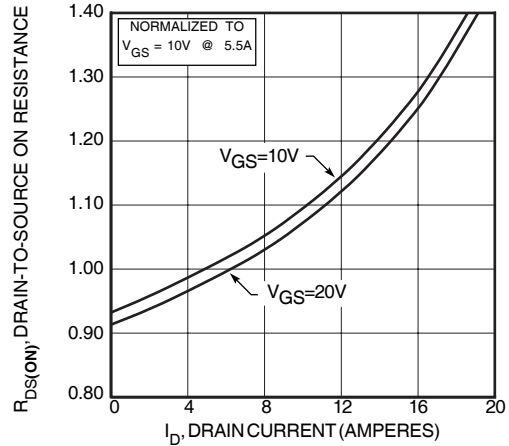

FIGURE 5, $R_{DS(ON)}$ vs DRAIN CURRENT

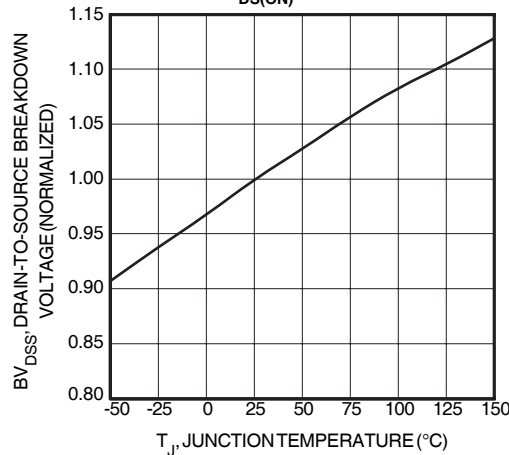

FIGURE 7, BREAKDOWN VOLTAGE vs TEMPERATURE

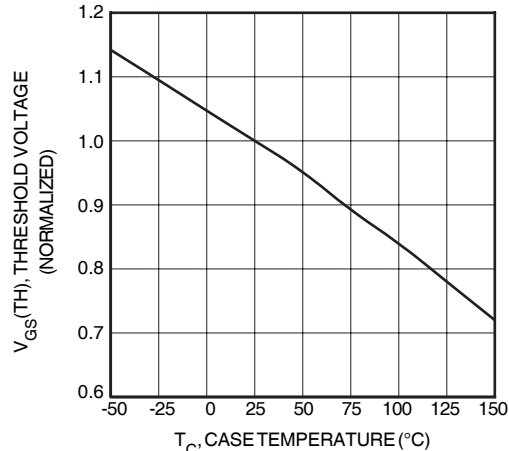

FIGURE 9, THRESHOLD VOLTAGE vs TEMPERATURE

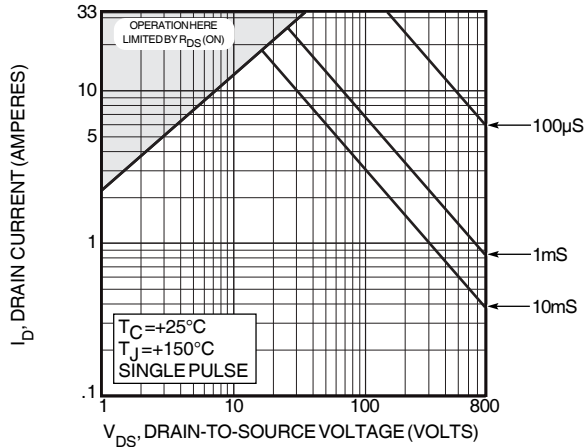

FIGURE 10, MAXIMUM SAFE OPERATING AREA

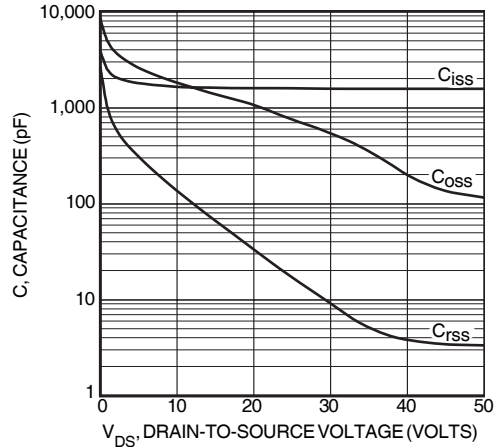

FIGURE 11, CAPACITANCE vs DRAIN-TO-SOURCE VOLTAGE

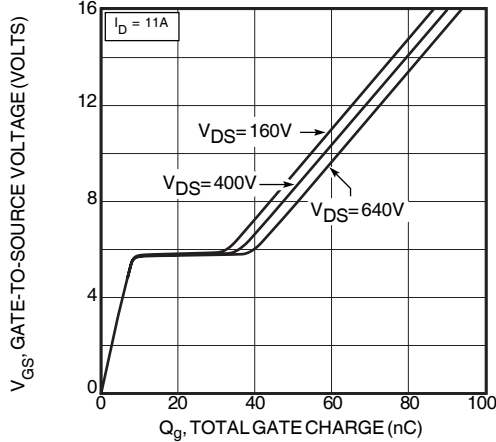

FIGURE 12, GATE CHARGES vs GATE-TO-SOURCE VOLTAGE

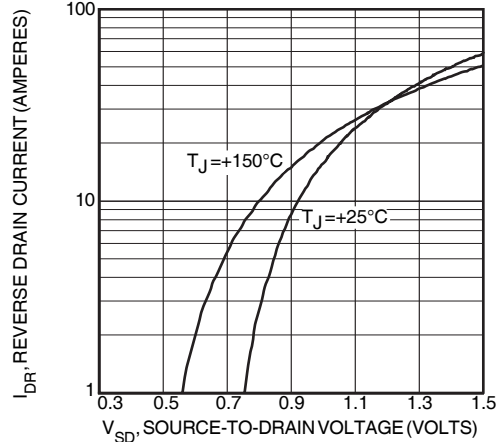

FIGURE 13, SOURCE-DRAIN DIODE FORWARD VOLTAGE

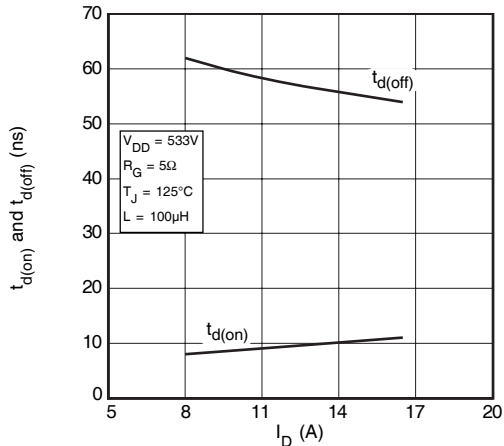

FIGURE 14, DELAY TIMES vs CURRENT

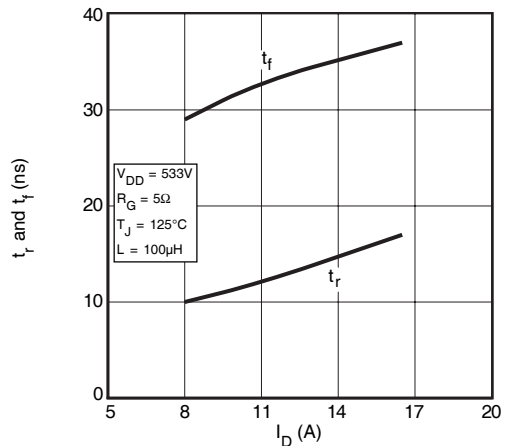

FIGURE 15, RISE AND FALL TIMES vs CURRENT

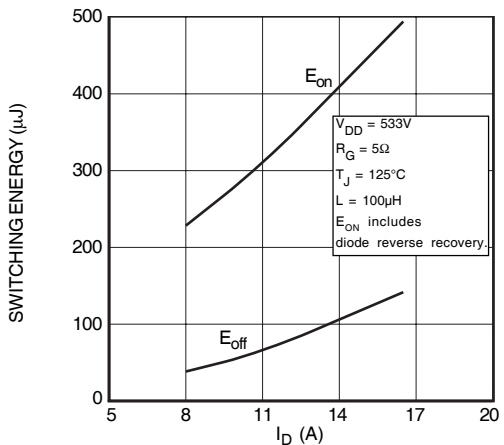

FIGURE 16, SWITCHING ENERGY vs CURRENT

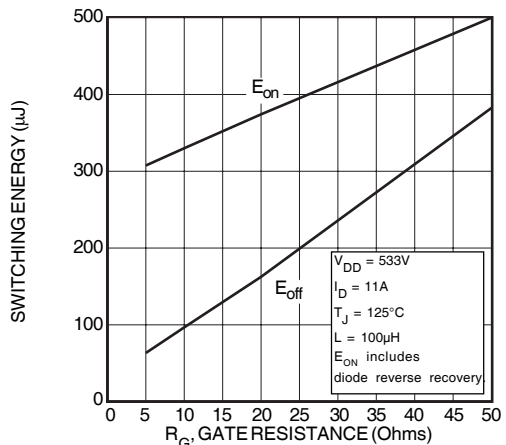

FIGURE 17, SWITCHING ENERGY vs. GATE RESISTANCE

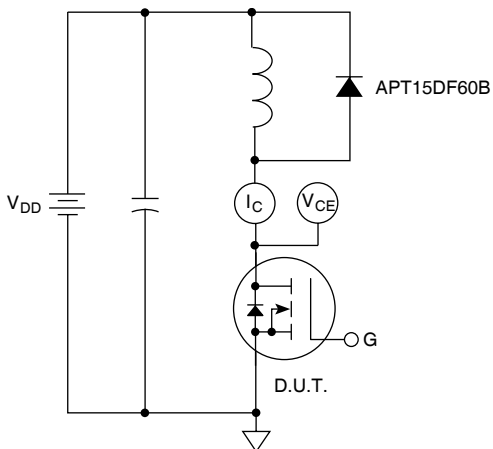
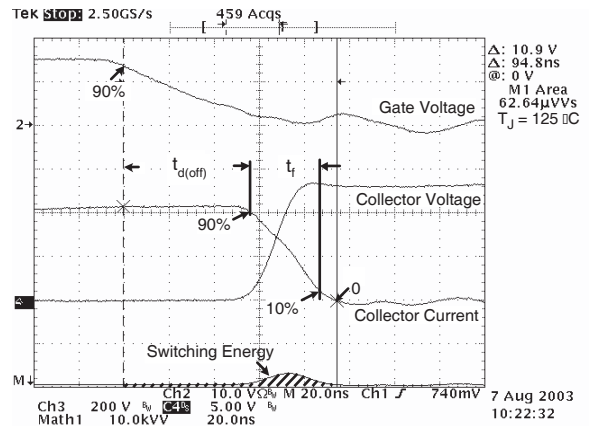
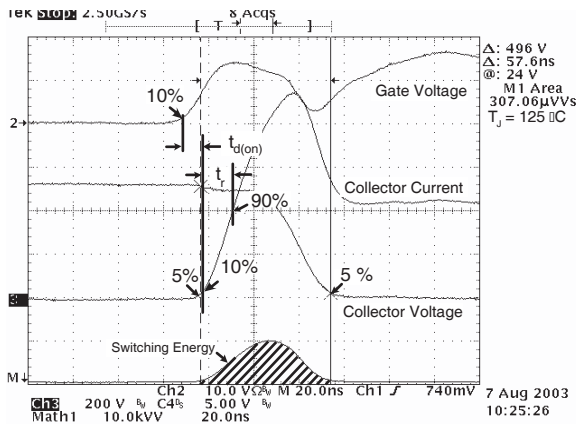
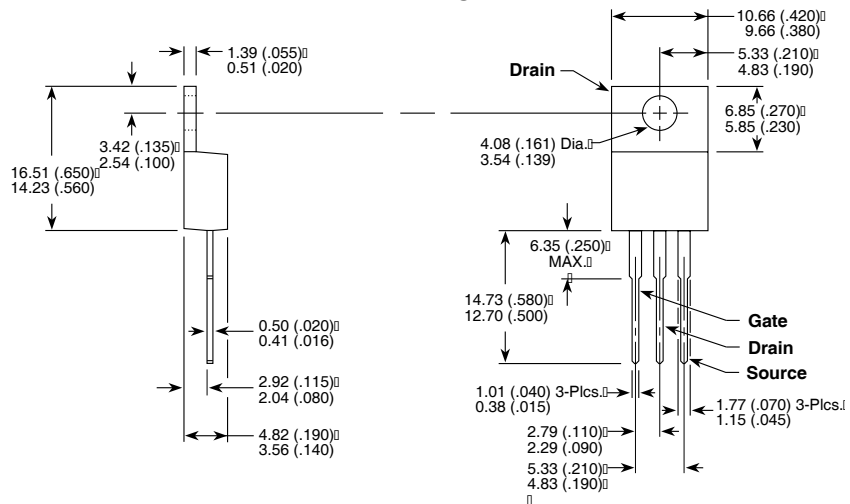

Figure 20, Inductive Switching Test Circuit

TO-220AC Package Outline



Dimensions in Millimeters and (Inches)

APT's products are covered by one or more of U.S. patents 4,895,810 5,045,903 5,089,434 5,182,234 5,019,522 5,262,336 6,503,786 5,256,583 4,748,103 5,283,202 5,231,474 5,434,095 5,528,058 and foreign patents. US and Foreign patents pending. All Rights Reserved.