

HITACHI

YS

No. 0081C-E

C29-F100 - 041, 051, 751,
081S, 121, 98*,
19*, 433, 941

SERVICE MANUAL

PAL/SECAM/NTSC

V1-F Chassis

NOTE:
PORTIONS OF THIS PRODUCT MANUFACTURED
UNDER A LICENSE FROM DESPER PRODUCTS,
INC. SPITALAIS, FRANCE, ARE SOLELY
OWNED BY DESPER PRODUCTS, INC.

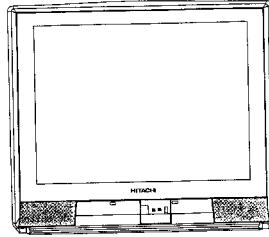

SUPER FLAT
F100
SCREEN TV

注意: 开始检修电视机机芯以前, 检修人员必须阅读这本检修手册中“有关安全上的预防事项”及“制品安全上的注意”两节。

CAUTION: Before servicing this chassis, it is important that the service technician reads the "Safety Precaution" and "Product Safety Notices" in this Service Manual.

目 录

有关安全上的预防事项	4
有关制品安全上的注意事项	4
技术参数	6
遥控发射器	6
各种调整控制机件	7
基本操作简介	8
电路说明	9-16
调整说明	17-21
电路图	22-25
印刷电路图	26-28
故障索引	29-30
替换零件表	31-45

CONTENTS

SAFETY PRECAUTIONS	2
PRODUCT SAFETY NOTICE	2
SPECIFICATIONS	6
REMOTE CONTROL UNIT	6
CONTROLS	7
GENERAL OPERATIONS GUIDE	8
CIRCUIT DESCRIPTION	9-16
ADJUSTMENT INSTRUCTIONS	17-21
BASIC CIRCUIT DIAGRAM	22-25
PRINTED WIRING BOARD	26-28
TROUBLESHOOTING	29-30
REPLACEMENT PARTS LIST	31-45

SPECIFICATIONS AND PARTS ARE SUBJECT TO CHANGE FOR IMPROVEMENT.

COLOR TELEVISION

February 1999

Hitachi Consumer Products (S)

TECHNICAL CAUTIONS

SAFETY PRECAUTIONS

WARNING: Since the chassis of this receiver is connected to one side of the Mains Supply during operation, service should not be attempted by anyone unfamiliar with the precautions necessary when working on this type of equipment. The following precautions should be observed.

1. Do not install, remove, or handle the picture tube in any manner unless shatter-proof goggles are worn. People not so equipped should be kept away while picture tubes are handled. Keep picture tube away from the body while handling.
2. When replacing chassis in the cabinet, all the protective devices are put back in place, such as: barriers, non-metallic knobs, adjustment and compartment cover or shields, isolation resistors-capacitors, etc.
3. When service is required, observe the original lead dress. Extra care should be taken to assure correct lead dress in the high voltage circuitry area.
4. Always use the manufacturer's replacement component. Especially critical components as indicated on the circuit diagram should not be replaced by other makes. Furthermore where a short circuit has occurred, replace those components that indicate evidence of overheating.
5. Before returning a serviced receiver to the customer, the service technician must thoroughly test the unit to be certain that it is completely safe to operate without danger of electrical shock, and be sure that no protective device built into the instrument by the manufacturer has become defective, or inadvertently defeated during servicing. Therefore, the following checks are recommended for the continued protection of the customers and service technicians.

INSULATION

Insulation resistance between the mains poles and any accessible metal parts should not be less than 7MΩ at 500V DC. Also, no flashovers or breakdown should occur during the dielectric strength test, to apply 4KV AC for one minute between the mains poles and any accessible metal parts.

X-RADIATION

TUBES: The primary source of X radiation in this receiver is the picture tube. The tube utilized in this chassis is specially constructed to limit X radiation.

For continued X radiation protection, the replacement tube must be the same type as the original, HITACHI approved type.

High Voltage

This receiver is provided with a hold down circuit for clearly indicating that voltage has increased in excess of a predetermined value. Comply with all notes described in this Service Manual regarding this hold down circuit when servicing, so that this hold down circuit is operated correctly.

Serviceman Warning

With minimum Black Level and Picture, the operating high voltage in this receiver is lower than 31.0kV. In case any component having influence on the high voltage is replaced, confirm that high voltage with minimum Brightness and contrast is lower than 33.0kV. To measure H.V. use a high impedance H.V. meter. Connect (-) to chassis earth and (+) to the CRT anode button. (See the following connection diagram).

NOTE: Turn the power switch off without 開 before the connection to the Anode button is made.

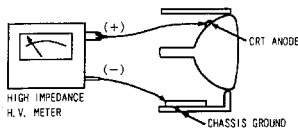

PRODUCT SAFETY NOTICE

Many electrical and mechanical parts in HITACHI television receiver have special safety related characteristics. These characteristics are often not evident from visual inspection nor can be protection afforded by them necessarily be obtained by using replacement components rated for higher voltage, wattage, etc. Replacement parts which have these special safety characteristics are identified in this Service Manual.

Electrical components having such features are identified by marking with a Δ mark in the schematics and on the replacement parts list in this Service Manual. The use of a substitute replacement component which does not have the same safety characteristics as the HITACHI recommended replacement one shown in the parts list in this Service Manual, may create electrical shock, infra X radiation, or other hazards. Product Safety is continuously under review and new instructions are issued from time to time. For the latest information, always consult the current HITACHI Service Manual. A subscription to, or additional copies of, HITACHI Service Manual may be obtained at a nominal charge from your HITACHI sales offices.

TECHNICAL CAUTIONS

High voltage limiter circuit operation check

1. Connect the high voltage voltmeter between the CPT anode (anode cap) and GND (CPT grounding lead).
2. Receive the broadcast signal and set the brightness and contrast VRs to max. Set the beam current to 1.6mA±10%.
- (After cut-off adjustment)
3. Set the AC input voltage to 220±3V.
4. Check that the constant high voltage is 29.5±1.0kV at this time.
5. Turn the switch of the set to off and connect the jig shown in Fig.3 at both ends of R964 as shown in Fig. 1.
6. With the brightness and contrast VRs left as set in item. 2 and with the AC input voltage stabilized at 220V, turn the picture disappears with a high voltage of 38.0kV or less.
7. Turn the switch of the set to off immediately after the check is completed.
8. Remove the adjust jigs and high voltage voltmeter.

NOTE: When connecting disconnecting the high voltage voltmeter to from the anode cap, be sure to turn the switch of the set off and do it after the residual high voltage is discharged to the chassis because the high voltage may remain at the anode cap.

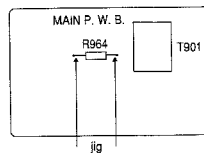

Fig. 1

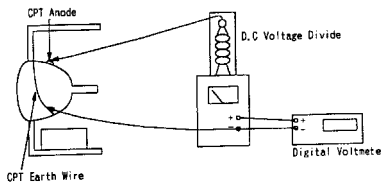

Fig. 2

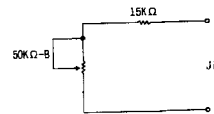

Fig. 3

有关安全上的预防事项

警告: 因为在动作期间, 这电视机的底盘与电源的一端互相连接, 所以对检修这类型号的机器所必须的预防措施为下熟悉的人, 不应该企图修机器。要检修必须遵守下列预防事项。

- 要装入, 取出或外理显象管时, 必须带上防碎玻璃的护目镜。外理显象管时, 不带这护目镜的人不可接近。显象管应放在离开人体的地方。
- 将底盘装入机箱里面时, 所有的保护装置, 如隔板, 非金属的调整钮, 小室盖子或小室屏蔽, 隔离用电阻, 电容器等, 也应该装回去。
- 开始检修之前, 应该注意原来的引线包层。尤其是在高压电路部分需要特别小心, 必须认清正确的引线包层。
- 要检修, 请一定要使用制造厂所指定的替换用机件, 尤其在电路注明几个特别重要的机件, 要替换这些机件绝不可使用其他厂家的制品。当电路发生短路时, 凡是有过热痕迹的机件都需要全部交换。
- 将修好的电视机送回顾客以前, 检修人员应该彻底检查机器以保证它完全安全, 绝没有电击的危险, 并确实检查机器内部的各种保护装置, 以保证这些部分没有因检修而失灵。

由于上面理由, 检修人员最好实行以下各项检查, 以保证顾客和自己的安全。

绝缘

电源电极与任何可触及的金属部分之间的绝缘电阻不可小于7兆欧姆(加上直流500伏电压时)。而且, 在电源电极与任何可触及的金属部分之间加上4千伏的交流电压(1分钟)而试验其绝缘强度时, 不可发生闪络或绝缘击穿等现象。

X射线

显象管: 这部电视机所产生的X射线, 其主要的来源是显象管。所以这部电视机所使用的显象管有特别的构造设计, 使X射线尽量减少。为了能继续防止X射线起见, 要交换显象管时, 请一定要使用相同型号的日立显象管。

高压

这部电视机装有一个高压限制电路, 可清楚地表示电压升高已超过额定值。进行维修服务时, 请根据本维修说明书有关此高压限制电路的所有注解说明去做, 则高压限制电路便可以正确地操作。

维修人员须注意

这部电视机在最小黑色电平 and 图象电流时的高电压是在31.0kV以下的。若更换了会影响高压的部件时, 一定请确认在最小亮度和对比度状况下的高电压是否低于33.0kV。

请使用高阻抗高压伏特计, 令其(-)连接底盘接地线, 令(+)连接CRT(阴极射线管)阳极电钮, 去测量高电压(H.V.)。(参考下面的连接图)。

注: 当要连接到阳极电钮以前, 一定要先把电源开关关掉。

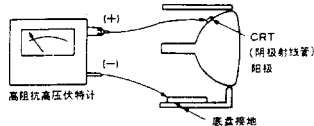

有关制品安全上的注意事项

日立电视机所使用的许多机件具有有关安全的特别性能。这种特别性能在表面上往往看不出来, 而且即使使用额定电压或功率更大的其他替换用机件, 也不一定可得到这些日立机件所保证的保护性能。在这本检修手册里面有指定

这些具有特别安全特性的替换用机件。在这本检修手册的简图和替换用机件表上附带△记号的机件, 就表示具备这种特别的安全特性。

如果不使用这本检修手册机件表上HITACHI所推荐的替换用机件而使用没有同样安全特性的其他替换用机件的话, 就可能发生电击、火灾、X射线等事故。

HITACHI对制品安全不断努力改进, 经常发出新的技术指令。如需要新的技术情报就请参看最新的HITACHI检修手册, 可向HITACHI销售公司预订或订阅“日立检修手册”, 只收取极少费用。

技术上须注意事项

高压限压电路操作检查

- 把高压伏特计连接在CPT阳极(阳极罩)和GND(CPT的接地线)之间。
- 试接收一个电台的广播信号, 且把亮度和对比度的VRs(可变电阻器)调到最大, 把射束电流调为 $1.6mA \pm 10\%$ (切断调整后)

- 把AC电的输入电压调为 $220 \pm 3V$ 。
- 此时, 检查恒定高压是否呈 $29.5 \pm 1.0kV$ 。
- 把设定开关关掉, 然后把图3所示的夹具接在图1所示的R964的两端。
- 以第2项所设定的亮度和对比度VRs, AC电流输入电压并保持稳定的220V状况下调节50kΩ可变电阻器以使影像消失掉, 高压不可超过38.0kV。
- 检查完毕后, 请立即关掉设定开关。
- 卸下调整夹具和高压伏特计。

注: 当把高压伏特计连接到阳极罩拆下时, 必须先关掉设定开关, 并且等残留高压电流都往底盘放电完毕之后, 才进行接拆工作。因为阳极罩上在关掉设定开关后, 还可能残留有高压电流。

MAIN印刷电路板



图1



图2

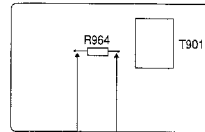

图3

SPECIFICATIONS (技术参数)

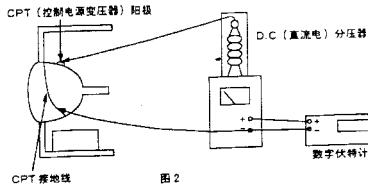
Reception system	625-LINES B.G./D.K/H PAL B.G./D.K/K1 SECAM NTSC50	Antenna input	75 Ω COAXIAL IEC TYPE
	525-LINES M/NTSC NTSC3.58 5.5,6,0,6.5 NTSC4.43-5.5,6,0,6.5 PAL 60	Colour picture tube	A68QC0259X / A68LQL185X
		Speaker (cm)	6 x 12 (x2)
		Sound output	7W x 2
Channel coverage Frequency range 44MHz-863MHz	CCIR : E2-12, E21-89, S01-3, S1-41	Power supply	041, 941, 121 : AC 200V-240V 50Hz/60Hz 98*, 192, 195 : AC 110V-240V 50Hz/60Hz 081S, 051, 433 : AC 200V-240V 50Hz/60Hz 751* : AC 240V 50Hz 191 : AC 127V 50Hz/60Hz
	Australia : AU0-12, AU28-69	Power consumption	041 : 119W(IEC Rated 155W) 191*, 98*, 433 : 155W 051, 751, 121 : 155W 081S, 121 : 155W
	OIRT : R1-12, R21-89	Weight (kg)	44kg
	JAPAN : J1-12, J13-62	Dimensions W x H x D (mm)	596 x 613 x 491
	U.S.A. : US2-13, J-W, US14-69		
	Hong Kong, U.K. : UK21-69		
	China : C1-12, C13-57, Z1-38		

* Specifications are subject to change without notice to improve performance.

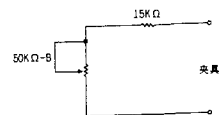
REMOTE CONTROL UNIT (遥控发射器上之控制机件)

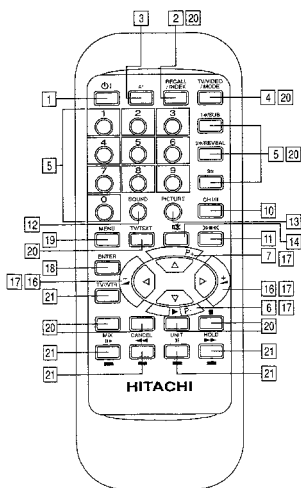

1	POWER ON/OFF SWITCH 电源开关
2	RECALL 召回
3	AI (For other models) 电脑控制 (适用于其他型号)
4	INPUT SELECTION 输入选择
5	PROGRAMME SELECTOR 节目选择
6	PROGRAMME DOWN 节目降
7	PROGRAMME UP 节目升
10	CH V/CH II (051/751/081S/982 only) CH V/CH II (051/751/081S/982 适用)
11	SPATIALIZER (For other models) 环绕声 (适用于其他型号)
12	SOUND 声音
13	PICTURE 图像
14	MUTE 静音
16	VOLUME UP/DOWN 音量升/降
17	CURSOR 光标
18	ENTER 决定
19	MENU 菜单
20	TELETEXT OPERATING KEYS (081S/982 only) 图文电视 (081S/982 适用)
21	VTR OPERATING KEYS (For other models) 录像机专用键 (适用于其他型号)

CONTROL (各种调整控制机件)

Front Panel
电视机的前面板

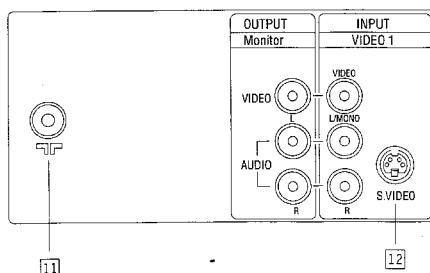
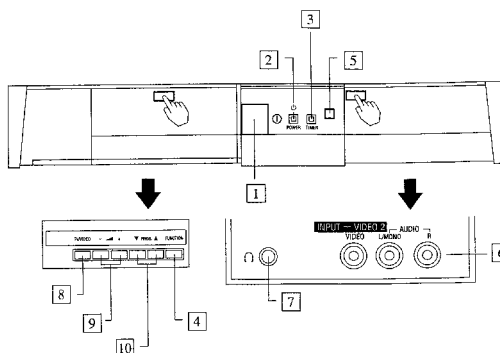

Rear Panel
电视机的后面板

1	POWER ON/OFF SWITCH 电源开关
2	POWER STANDBY INDICATOR 电源/等待指示灯
3	TIMER INDICATOR 定时指示灯
4	FUNCTION 功能键
5	REMOTE CONTROL RECEIVER 遥控接收器
6	INPUT 2 INPUT TERMINAL INPUT 2 输入端子
7	HEADPHONE JACK 耳机插座
8	INPUT SELECT 输入选择
9	VOLUME UP/DOWN 音量升/降
10	PROGRAMME UP/DOWN 节目升/降
11	ARIAL TERMINAL 天线端子
12	AV INPUT TERMINALS AV 输入/输出端子

GENERAL OPERATIONS GUIDE (基本操作简介)

With this TV set, all adjustments/settings are performed by selecting from menu screens. Different menu screens and details of adjustments/settings are shown below. To access the menu screen, press the **MENU** button, then select the item by pressing the cursor buttons and set it by pressing the **ENTER** button.

在使用本電視機時，所有調整/設定都可從菜單屏幕上選擇。各種菜單屏幕以及調整/設定的細節，如下所示。您可先按下 **MENU** 鍵以進入菜單屏幕，然後按下游標鍵以選擇所要項目，並按下 **ENTER** 鍵以確認設定。

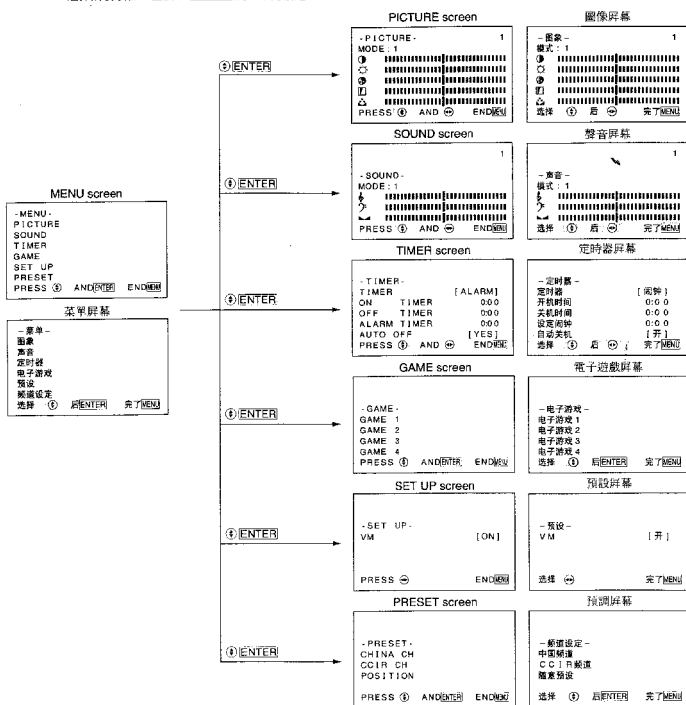

CIRCUIT DESCRIPTION (电路说明)

Selection and CPU circuitry

IC type, M37221MA, performs functions like IIC controls, channel selection, on-screen displays, search tuning, systems selection amongst others. The pin functions of M37221MA is presented in table form as shown below :

PIN NO.	NAME	I/O	FUNCTION
1	H.BLK	Input	Horizontal synchronous signal i/p pin for OSD
2	V.BLK	Input	Vertical synchronous signal i/p pin for OSD
3	RETURN1	Input	Return signal of front panel matrix
4	RETURN2	Input	Return signal of front panel matrix
5	COMB	Output	Output for NTSC and VIDEO signal
6	TIMER	Output	Output for timer LED. H: timer set, L: normal
7	N.C.		
8	ON OFF MUTE	Output	Mute control during power on/off
9	VM Cont.	Output	Velocity Modulation control on/off
10	R/C	Input	Remocon serial data i/p from receiver unit
11	SYNC	Input	Horizontal signal i/p. Used to detect presence of RF signal after A/D conversion
12	50/60	Output	Forced output to control frequency of receiving picture
13	SCAN1	Output	Output signal at front panel to control program up/down
14	SCAN2	Output	Output signal at front panel to control volume up/down
15	SCAN3	Output	Output signal at front panel to control Function & TV/VIDEO keys
16	POWER	Output	Power ON/OFF control. H: ON, L: OFF
17	BEEP	Output	BEEP sound o/p. L:off, PWM 50% duty cycle: ON
18	GND		
19	X.IN	Input	Clock in
20	X.OUT	Output	Clock out
21	GND		
22	Vcc		
23	S-DET	Input	S VIDEO input detect.
24	N.C.		
25	RESET	Input	Resets MCU via RESET IC, I003. H: normal, L: RESET
26	CH.MUTE	Output	Mute control during channel change
27	SPATIALIZER	Output	Spatializer control o/p
28	N.C.		
29	AFC	Input	AFC voltage i/p. Used together with SYNC to detect presence of RF signal after A/D conversion
30	N.C.		
31	SW1	Output	Select main signal system
32	SDA-1	I/O	IIC data i/o
33	SW2	Output	Select main signal system
34	SCI-1	I/O	IIC clock select
35	SW3	Output	Select main signal system
36	SW4	Output	Select main signal system
37	SDA	I/O	IIC data i/o for EEPROM
38	SCL	I/O	IIC clock select for EEPROM
39	BLK	Output	OSD blanking output signal
40	B	Output	Blue output for OSD
41	G	Output	Green output for OSD
42	R	Output	Red output for OSD

BLOCK DIAGRAM FOR SIGNAL CIRCUIT

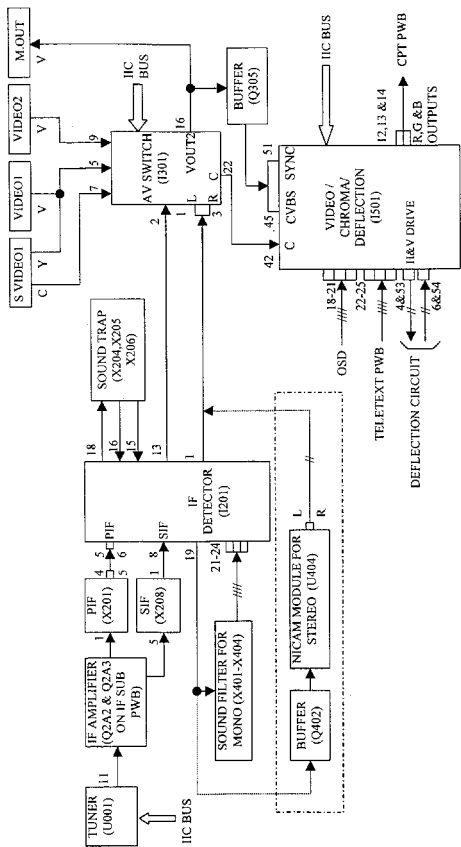

TUNER AND IF CIRCUIT

The tuner (U001) used on this chassis is powered by the 9V supply, it is IIC Bus controlled and covers VHF, UHF and CATV Band (Mid, Supper and Hyper). The IF circuit consists of SAW X201, SAW X208, Q2A2, Q2A3 and I201 (LA7566). The IF output from tuner (pin 11 of U001) is applied to amplifiers Q2A2 for PIF and Q2A3 for SIF (both amplifiers are on IF Sub PWB) through E2A1 connector. Outputs of amplifiers return through E2A2 and connected to SAW filter X201 (PIF) and X208 (SIF). At the input of X201 (PIF), Q205 serves to select the systems between (B/G, I, D/K) or (M).

After that, demodulation and sound systems selection are made at I201 (LA7566).

For mono sound system, the output of pin 19 is sent out a series of bandpass filters to select required sound system (B/G, I, D/K or M). The selected signal (pin 21 or 22 or 23 or 24) is then demodulated in I201. The sound output is given at pin 1.

For stereo sound system, the output of pin 19 is sent to buffer amplifier (Q402) and output is then connected to NICAM MODULE (U404) where sound system selection and demodulation are made. At I201, sound systems selection are as follow :

	B/G	I	D/K	M
I201 pin 22	H	H	L	L
I201 pin 23	H	L	H	L
Q205 Base	L	L	L	H

SIF signal is removed by using sound trap filters (X204, X205 and X206) and giving B/G, I, D/K video signal at pin 15 and M video signal at pin 16. Those video signals are switched internally and give output at pin 13 of I201.

VIDEO/CHROMA

Composite video signals from RF, Video 1 and Video 2 entered I301 via pin 2, 5 and 9 respectively. However, S Video 1 send Y and C signals separately to I301 via pin 7 and pin 5. The same pin (pin 5) is used for Y signal with S Video 1 and V signal with Video 1.

At I301, which input signals (RF, S Video 1,

Video 1 or Video 2) to be proceeded are selected and then, transferred to I501 via pin 16. These selection procedures are controlled by IIC Bus.

If one of the signal (RF, Video 1 or Video 2) is selected at I301, I501 (TB1226AN) will receive composite video signal at pin 45, 42 and 51. Y/C separation is performed internally.

If the signal selected at I301 is S Video 1, I501 will receive C signal at pin 42 and Y signal at pin 45 and 51. Therefore, Y/C separation is not required.

IC	I301	I501
I/O	Input	Output
Pin no	2 5 7 9 16 22 45 42 51	Input
RF	V - - - -	V V V V V V V
Video 1	- V - - - -	- V V V V V V V
Video 2	- - - - -	- V V V V V V V
S Video 1	- - - Y - -	- Y C Y C Y

- V = Composite Video Signal
- Y = Luminance Signal
- C = Chroma Signal

I501 (TB1226AN) which incorporates VIDEO/CHROMA/DEFLECTION is used to perform auto color identification of PAL/SECAM/NTSC, sync separation, AFC, H/V oscillator and output stage RGB signals etc. IIC Bus has controlled over this I501 i.e. Brightness, Contrast, Color, Sharpness and Tint can be changed.

For all systems (PAL/SECAM and NTSC), Y and C are separated by using bandpass and trap method, which can change each center frequency internally in I501. And also in I501, color identification and decoding are performed with internal 1HDL and x'tal 16.2 MHz at pin 40 instead of conventional 4.43 MHz for PAL/SECAM and 3.58 MHz for NTSC x'tal. After that, the result R, G, B signals are then combined with OSD R, G, B signals from pin 23-25 by switching operation at pin 21 (D YS), pin 22 (A YS). The outputs are finally emerged from pin 12-14 as the R, G and B. Then, R, G and B output signals are sent to CRT PWB.

Internal sync separator and H/V oscillator of I501 produce H drive and V drive signals which are sent to Deflection circuit for processing of Horizontal and Vertical scanning.

HORIZONTAL DEFLECTION

This circuit used the horizontal deflection yoke(H. DY) to deflect the electron beam of the CRT horizontally. It also generates high-voltage and medium/low voltage power supplies through FBT.

At pin 51 of I501, the composite video signal from Q305 is applied to the internal sync separator and phase detector/correction of I501, the resulted horizontal drive pulse is output from pin 4 of I501.

The horizontal drive pulse is supplied to the horizontal drive circuit consisted of Q708, Q709 and T701.

At the horizontal output transistor Q708, it generate a FBT pulse of approximately 1100V at the collector and also cause sawtooth current to flow to the H. DY, thus deflecting the electron beam in the CRT horizontally.

This FBT pulse also causes a high voltage (H. V) and medium/low voltages(i.e 200V, 56V, 11V, 25V) to be generated at the secondary circuit of the FBT T702.

The pincushion distortion correction circuit in this chassis is to increase the H. DY current to correct the pincushion distortion at both sides of screen. The vertical sawtooth wave of the V. DY is input to Q665 and output as a parabolic wave. This parabolic wave modulates the horizontal pulse voltage at the cathode of diode modulator D703 through Q663, Q662 and Q661 with a vertical period to vary the H. DY voltage.

The high-voltage beam current is supplied from +B(130V) to the ACL(Automatic Contrast Limiter) terminal of FBT. This produces a voltage proportional to the variations in the brightness at the ACL terminal. This voltage is applied to Q664, Q663 to correct meandering of the picture due to changes in brightness and also apply to Q665 through R663 to correct the size due to brightness change.

VERTICAL DEFLECTION

At I501, the composite video signal from pin 51 are applied to the internal integrated circuit, V separation circuit and V C/D circuit which counts down the horizontal frequency to obtain the vertical frequency. C6A2 at pin 52 of I501 is used for ramp generation, and produces the required sawtooth waveform output from pin 53.

The vertical drive output from pin 53 of I501 is applied to pin 4 of I601 via R6A2, and the vertical output to drive the DY is made available at pin 2. The voltage switching circuit in I601 increases the power voltage at pin 3 during the flyback period to make the flyback line faster.

The V deflection voltage that occurs is added to the DC voltage from pin 2 of I601, the result is applied to pin 54 of I501 and determine the linearity and vertical height.

POWER SUPPLY CIRCUIT

The power supply circuit of V1 chassis is as below.

(1) **Starting Operation.**

Power switch S901 turned ON→Rectified at D901→D904→Voltage at Q903 base rises→First switching pulse generated at winding P1-P2 of T901→ Drive voltage →Provides to Q905 of winding B1-B3 of T901→ Q905 supply stable drive voltage and L903 provide drive current to Q903 base→Come into normal operations.

(2) **Switching Constant Voltage Operation.** AC input voltage rises or +B load decreased (picture get dark)→ +B(130V) rises→ Ic increased at Q951→ Ic increased at IC901 → Ic increased at IC901→ Voltage decreased at pin 5 of IC901→ ON period of Q901 increased→ ON period of Q903 decreased→ Positive voltage of D951 anode decreased→ +B voltage falls→ +B voltage stabilized.

(3) **Standby Operation.**

Remote control power OFF→I001 pin 16 → Q954 off → Q953 off → I501 Vcc pin 3 → Horizontal deflection stopped. Also → Q952 off → R965 connect into R664 → Voltage of Q951 base rises → period of Q903 is slightly decreased by IC901 → +B voltage falls(about 65V) → Power consumption decreased. +5V power provided from T901(S2) winding through D952 and C954 → 5V at pin 22 of I001 stabilized by I004.

DYNAMIC FOCUS CIRCUIT

In a CRT, the focus electrode potential must be adjusted to produce a finely focused dot on the face of the tube. The distance between the electron guns and the tube face increases as the beam is deflected towards the extremities of screen. This means that the optimum Dynamic Focus voltage varies according to the part of the screen being scanned.

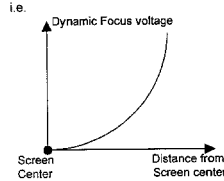

Due to above, the variation in focus between the center and the extremities of the screen is always a problem, especially in Flat CRT.

In C29-F100 chassis, the following Dynamic Focus circuit is used to improve the focus at the horizontal extremities of CRT by adding a parabolic voltage waveforms at the horizontal scan frequency on focus voltage. To obtain a dynamic focus waveform, a waveform from the horizontal output circuit across C725 is supplied to Dynamic Focus Transformer TF01 through CF03. After the TF01, the parabolic secondary voltage of TF01 is supplied to Dynamic Focus pin of CRT through Flyback Transformer T702, and optimize focus at the left and right extremities of screen.

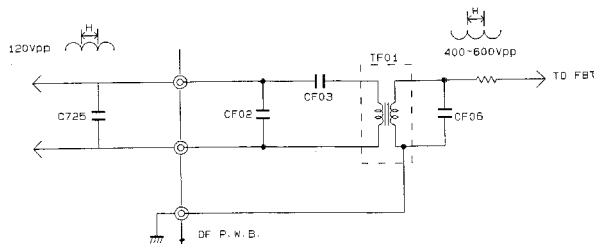

DYNAMIC FOCUS PWB CIRCUIT

AUDIO CIRCUIT

The AV switch I301 receive audio signals from the following 3 locations:
 (1) Mono sound from I201 pin 1, 3 or Stereo sound from U404(Nicam/A2 module) pin1(L) pin 3(R).
 (2) Video 1 in via pin 4(L1) and pin 6(R1).
 (3) Video 2 in via pin 8(L2) and pin 10(R2).

The signals to be proceeded are selected in I301. I301 is controlled by IIC bus. Outputs of I301, pin 21 & 23, are sent both to Monitor out and pin 2 & 9 of Audio Control(I401). IIC bus control I401 for volume, left and right audio output, treble and bass outputs.

L-out and R-out of I401, pin 7 and pin 17 respectively, are joined with MUTE control transistors(Q408, Q409 and Q410). These transistors are controlled by Micro IC(I001). When mute is requested Q409 and Q410 are grounded and no signal is sent to audio amplifier(I451) and made audio mute possible. Otherwise, signals are sent to pin 2 and 5 of audio amplifier I451. After amplification of audio signals, they are then sent out as audio outputs of system via pin 12 and 7 to headphone and speakers.

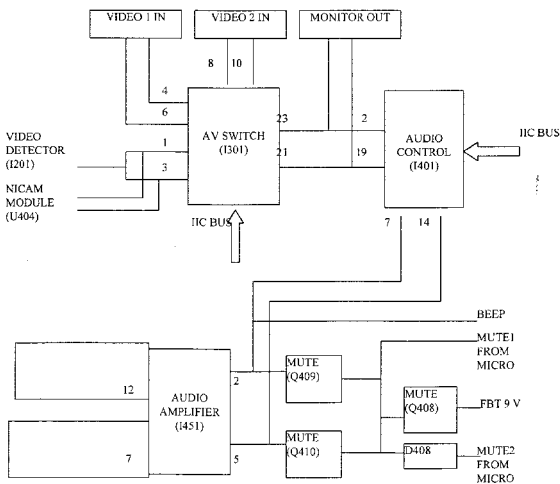

NICAM / A2 (For NICAM / A2 models only)

The analog sound IF signal is being inputted to a high pass filter. It has a frequency response whereby the chroma signal will be suppressed to prevent interference. The signal is amplified before injected into the IC1.

The SIF signal after received by IC1 will perform either a digital or analog demodulation based on the carrier frequency being identified. The table below shows the standard specifications of different systems.

No.	Specification	NICAM		A2	
		UK	Scandinavia / Spain	Channel FM1	Channel FM2
1	Carrier frequency	6.552MHz	5.85MHz	5.5MHz	5.7421875Mhz
2	Carrier frequency of analog sound component	6.0Mhz FM mono	5.5Mhz FM mono	-	-
3	Vision/sound power difference	10dB	13dB	13dB	20dB
4	Pilot carrier frequency	-	-	-	54.6875kHz
5	Modulation frequency	-	-	-	mono: unmodulated stereo : 117.5kHz dual : 274.1kHz

In NICAM system, the digital encoded data contains the information bits on NICAM, Stereo, Bilingual or FM mode. It can be selected using remote controller, either CH I / II / FM. The system will automatically switch to stereo mode if the error received exceeds a certain limit.

Whereas in A2 system, a pilot carrier frequency imposed on the FM2 Channel shows the present of stereo and bilingual sound. The mode of operation depends on the modulation frequency received and user's selection.

Remote controller	NICAM	A2
CH I	NICAM STEREO	A2 STEREO
CH II	BILINGUAL	BILINGUAL
FM	FM mono	FM mono

After demodulation and decoding, the sound is being outputted to the L and R channel. All the IC1 operation is being controlled by I2C bus.

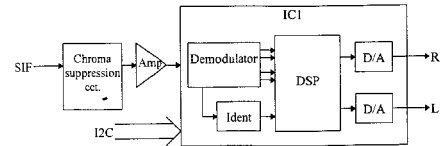

Block diagram of the NICAM/A2

Teletext Circuit (T/TEXT models only)

In teletext mode, the tv signal is being amplified by the IC001. The signal after amplification is injected into the frequency response circuitry for better reception. It is received by IC5201 where acquisition, decoding and data processing are being performed. The RGB and Blk signals are outputted.

On the other hands, IC5202 received the commands from the main μ con through I2C Bus. It analyzed and re-decoded the commands for controlling IC5201 operation.

Whereas in Mix and TV modes, a "HIGH" is outputted from IC5202 to switch on Q006. The signal that had been amplified is redirected to the video out pin.

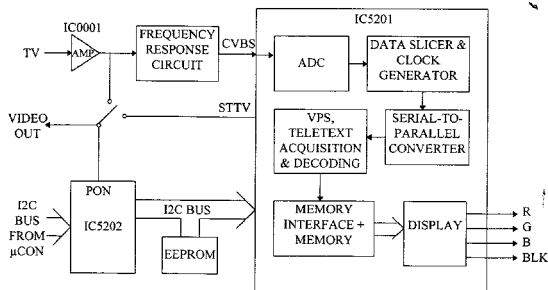

Block diagram of Teletext decoder

ADJUSTMENT INSTRUCTIONS
(调整说明)

IIC ADJUSTMENTS

Most of the adjustment items in V1 chassis are control by IIC. Any changes on CRT, CPU IC, Video/Chroma IC or V. deflection IC(I601), please readjust the items shown in table 1(Pg. 21). To start the IIC adjustment, please ensure the AC power switch is at "off" position. Press the **[TV/VIDEO]** button on the front panel and then press the power switch while pressing **[TV/VIDEO]** button. Release all buttons after the following displays appeared on screen.

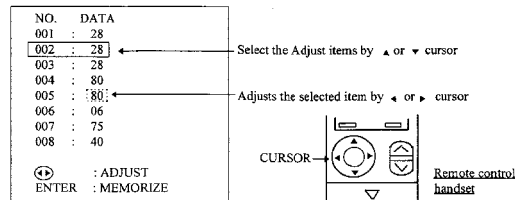

To select the adjustment items(e.g. H. phase, sub-brightness level etc...), press the **▲** or **▼** cursor button on Remote control handset. To adjust the data of selected item, press the **◀** or **▶** cursor button on Remote control handset.

After completed the adjustments, press the **[ENTER]** button on Remote control handset (memorized). Press **[MENU]** button or turns off the TV set to end the IIC adjustment.

VERTICAL CENTER ADJUSTMENT

PREPARATION	PROCEDURES
<ol style="list-style-type: none"> Turns on the TV set & heat run about 5 min. Receive the circular pattern signal. AC 220+ - 1v. 	<ol style="list-style-type: none"> Select the IIC control address No 54. Set the horizontal center line to vertical center marker of CRT by adjustment of IIC. i.e. <p>Vertical center marker of CRT</p>

VERTICAL SIZE ADJUSTMENT

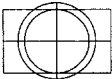
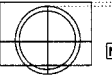
PREPARATION	PROCEDURES
<ol style="list-style-type: none"> Turns on the TV set & heat run about 5 min. Receive circular pattern signal (PAL). Set all picture settings to normal condition (i.e. Brightness : Center, Contrast : Max AC 220 +1V 	<ol style="list-style-type: none"> Select the IIC control address No 55. Adjust IIC data to obtain the following condition. i.e. <div style="text-align: center;">  </div> <p>PICTURE TOP : Inner circle reach the edge of TV raster. PICTURE BOTTOM : Inner circle reach the edge of TV raster.</p> Receive the NTSC circular signal, and check the picture size after the above V size adjustment. If a > 0mm, go back to IIC control No 54(V-center adjustment), increase the IIC data by 1 position. <div style="text-align: center;">  </div>

DOUBLE FOCUS ADJUSTMENT (Adjust after the Vertical Size adjustment)

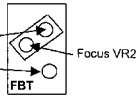
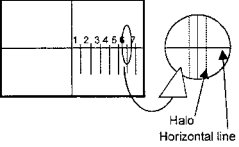
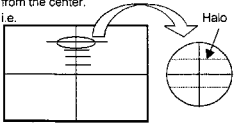
PREPARATION	PROCEDURES
<ol style="list-style-type: none"> Turns on the TV set & heat run about 5 min. Receive the Cross Latch pattern signal. AC 220 +- 1V. Turns the black level to the very point where background of Cross Latch pattern becomes dark. The sketch of FBT with VR1 & VR2 is as below. i.e. <div style="text-align: center;">  </div> 	<ol style="list-style-type: none"> Turns the Focus VR2 gradually clockwise until the halo of the number 6 vertical line disappear and horizontal line is at min. width. <div style="text-align: center;">  </div> Turns the Focus VR1 gradually clockwise so that no halo of Horizontal center line appears and width of the horizontal line(*) becomes min.. *the position cross to fourth horizontal line from the center. i.e. <div style="text-align: center;">  </div>

+B ADJUSTMENT

PREPARATION	PROCEDURES
<ol style="list-style-type: none"> AC input voltage 220+-5V(50HZ). Turns on the set and set the brightness and contrast to Max. (Signal : PHILIPS Pattern) After 30 sec heat-run, check & adjust the +B voltage. <p>Measuring Point : +B voltage : C953 + side GND : C953 - side</p>	<ol style="list-style-type: none"> Adjust VR951 to obtain +B voltage as below. +B voltage = 130 +-0.3V

SIDE PIN-CUSHION DISTORTION ADJUSTMENT

PREPARATION	PROCEDURES
<ol style="list-style-type: none"> Perform this adjustment after the purity and convergence adjustment. Receive the circular pattern signal. Set the Contrast to max. and Back level to normal. The horizontal size adjustment. Set the horizontal size VR R657 to the mechanical center. Perform this adjustment after the Vertical size adjustment. 	<ol style="list-style-type: none"> Adjust R656 so that all vertical lines except the lines at both the left and right ends are straight. Receive the Cross Hatch signal, check that the vertical lines are straight except the 1st outer vertical line(R/L).

HORIZONTAL CENTER ADJUSTMENT

PREPARATION	PROCEDURES
<ol style="list-style-type: none"> Perform this adjustment after the Side pin adjustment. Receive the circular pattern signal. 	<ol style="list-style-type: none"> Select the IIC control address No 06. Adjust the picture center to meet the CRT geometrical center.

HORIZONTAL SIZE ADJUSTMENT

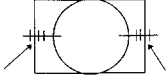
PREPARATION	PROCEDURES
<ol style="list-style-type: none"> Perform this adjustment after H. center adjustment. Receive the HITACHI circular pattern signal(PAL). Set the Contrast at Max. and others at 0(center). 	<ol style="list-style-type: none"> Turn R657 to Max(clockwise). Adjust R657 so that the average reading of right and left is 1.5 ~ 2.0. i.e. <div style="text-align: center;">  </div>

WHITE BALANCE ADJUSTMENT

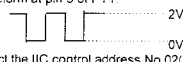
PREPARATION	PROCEDURES
1. Switch on the TV set for at least 20mins.	1. Connect and measure the waveform at No 5 pin of connector PY 11 (or pin 14 of I501).
2. Adjust this adjustment after the Purity adjustment.	2. Select the IIC Control address No 01 (Cut-off red) and adjust the data to obtain the following waveform at pin 5 of PY1.
3. Ensure the vertical incident illumination on CRT surface to be 20 lux or less.	
4. Receive the white balance raster.	3. Select the IIC control address No 02 (Cut-off green) and No 03 (Cut-off blue), adjust both data to the same data number as in address No 01.
5. Set the following settings by Remote control handset. Contrast : Max Brightness : Center Color : Min	4. Select the IIC control address No 04 (Blue drive) and No 05 (Red drive), adjust both data to 80.
	5. Turn the screen VR of FBT fully counter-clockwise.
	6. Press the TV/VIDEO button 3 times to obtain the lateral line mode.
	7. Turn the screen VR clockwise and set it to the position where the bright colored line starts to appear.
	8. Release the lateral line mode by pressing TV/VIDEO button once.
	9. Set the W/B meter probe at the center of the screen.
	10. Do the W/B adjustment to the desired WB color temperature by using the following keys of IIC.
	IIC Address No
	R BKG 01
	G BKG 02
	B BKG 03
	R DRIVE 04
	B DRIVE 05

Note : To obtain the low brightness and high brightness conditions, adjust the Brightness control of remote control handset.

SUB-BRIGHTNESS ADJUSTMENT

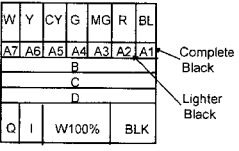
PREPARATION	PROCEDURES
1. Switch on the TV set for at least 20mins.	1. Select the IIC control address No. 09.
2. Adjust this adjustment after the Horizontal size and Side pin cushion adjustment.	2. Adjust the data until A1 portion becomes black and A2 portion becomes lighter black.
3. Ensure the vertical incident illumination on CRT surface to be 20 lux or less.	i.e.
4. Receive color bar pattern signal.	
5. Set the following settings by remote control handset. Contrast : Min Color : Min Brightness : Center	

SUB-TINT ADJUSTMENT

PREPARATION	PROCEDURES
1. Receive the color bar signal (NTSC).	1. Connect and measure the waveform at pin 5 of EY1 (R signal).
2. Set the following settings by Remote Control handset. Contrast : Max Tint : Center Color : Center Black Level : Center Sharpness : Center	2. Select the IIC address No. 08.
	3. Adjust the data to obtain the following waveform (s and s'' to same level).
	

TABLE 1 : IIC-BUS CONTROL/ADDRESS

ADJ No.	NAME OF ADJUSTMENT	DATE (INITIAL)	ADJUST WHEN CHANGE		
			MEMORY I502	CPT V1	V/C IC I501
1	R CUT OFF	0-255 (0)	O	O	O
2	G CUT OFF	0-255 (0)	O	O	O
3	B CUT OFF	0-255 (0)	O	O	O
4	G DRIVE GAIN	0-255 (80)	O	O	O
5	B DRIVE GAIN	0-255 (80)	O	O	O
6	HORIZONTAL POSITION	0-31 (10)	O	O	X
38	R-Y SECAM W/B	0-15 (8)	O	X	X
39	B-Y SECAM W/B	0-15 (8)	O	X	X
54	V. POTISION	0-7	O	O	O
55	V. SIZE	0-127 (40)	O	O	O
57	V. S CORECTION	0-127 (40)	O	O	O
59	V LINEARITY	0-31 (0)	O	O	O
60	MUTE MODE	0-3	O	X	X

Note : Do not adjust other ADJ. NO, except the items shown in table 1.

CIRCUIT DIAGRAMS
(电路图)

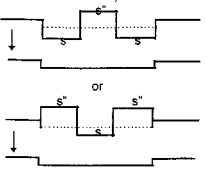
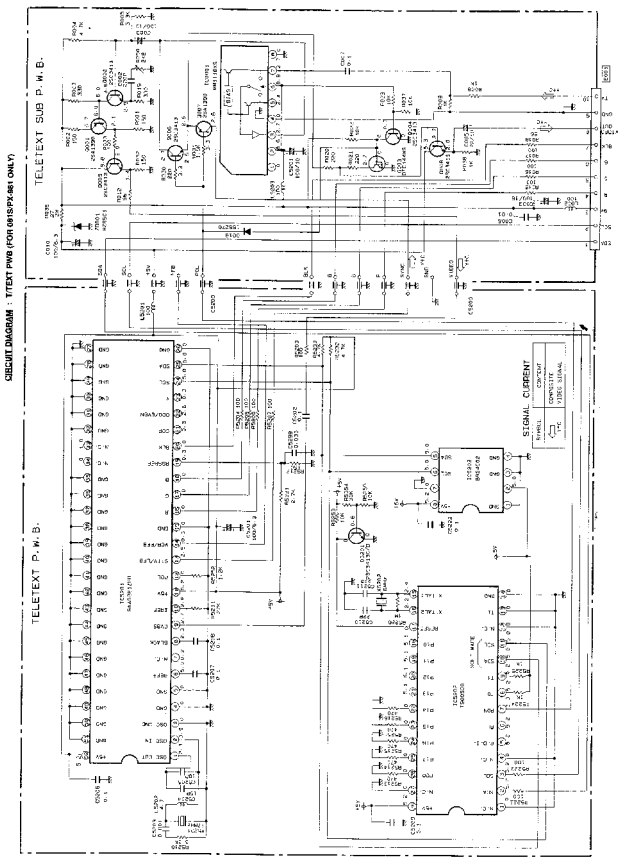

C29 - F100 CIRCUIT DIAGRAM

PRODUCT SAFETY NO
replacing any of these or
safety of the receiver. th

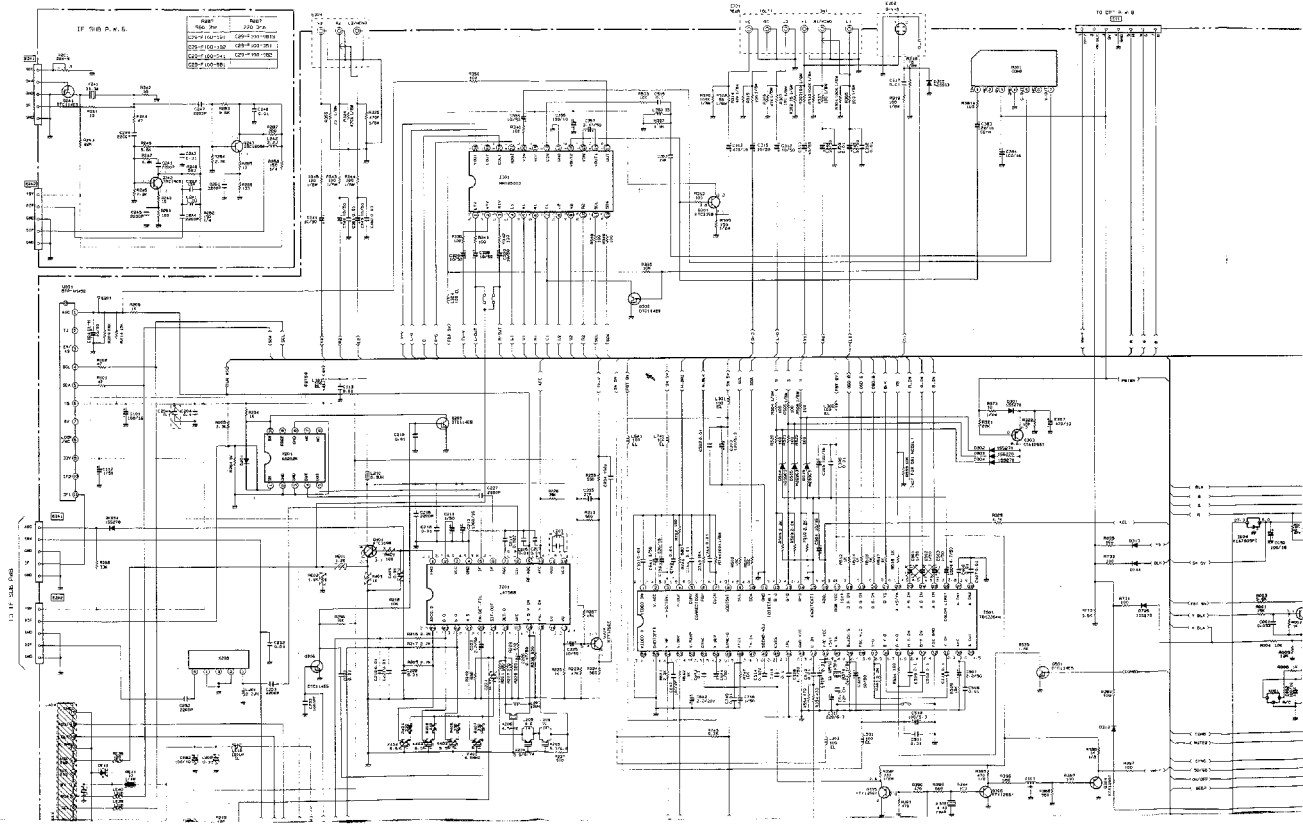

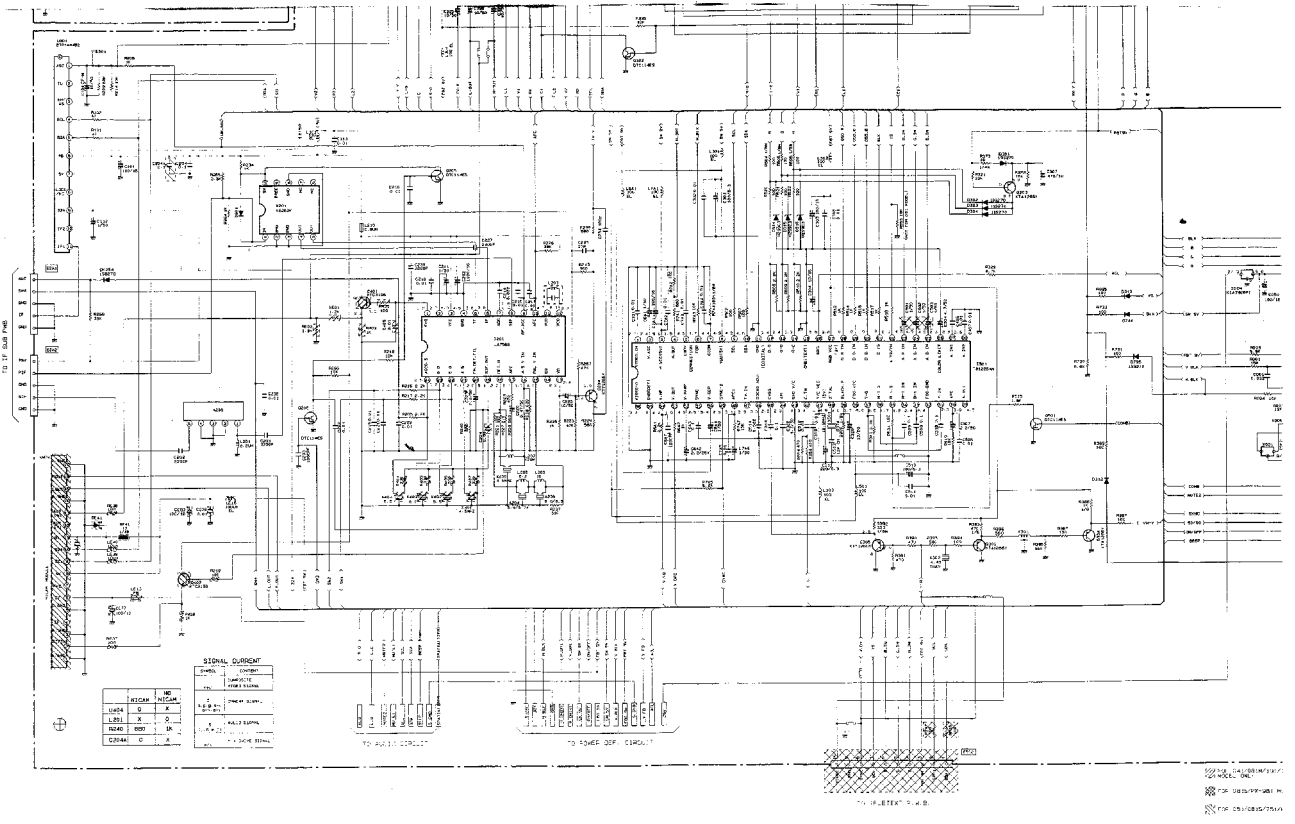

PRODUCT SAFETY NOTE - Components marked with a Δ and shaded have special characteristics important to safety. Before replacing any of these components, read carefully the **PRODUCT SAFETY NOTICE** of the Service Manual. Don't degrade the safety of the receiver through improper servicing.

C29 - F100 CIRCUIT DIAGRAM

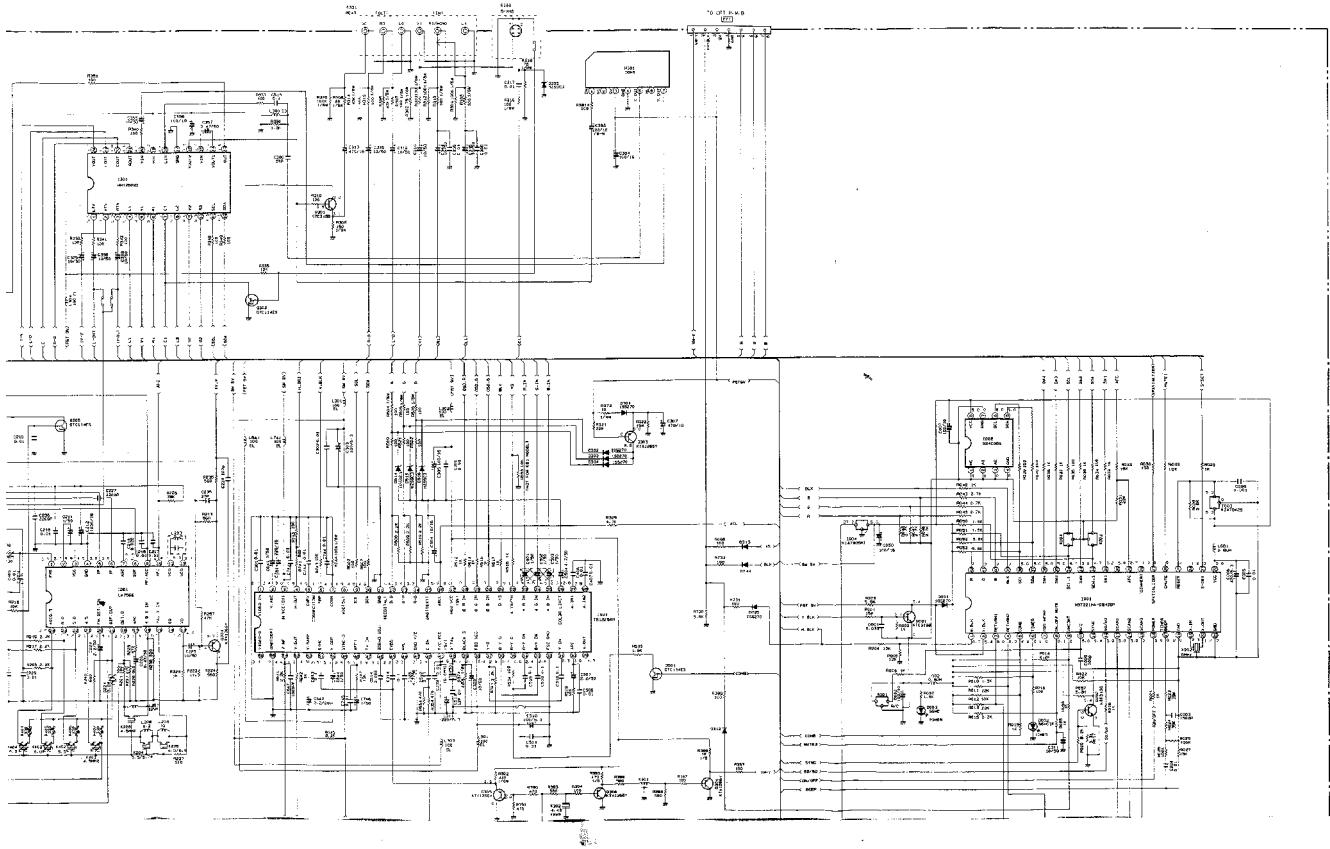

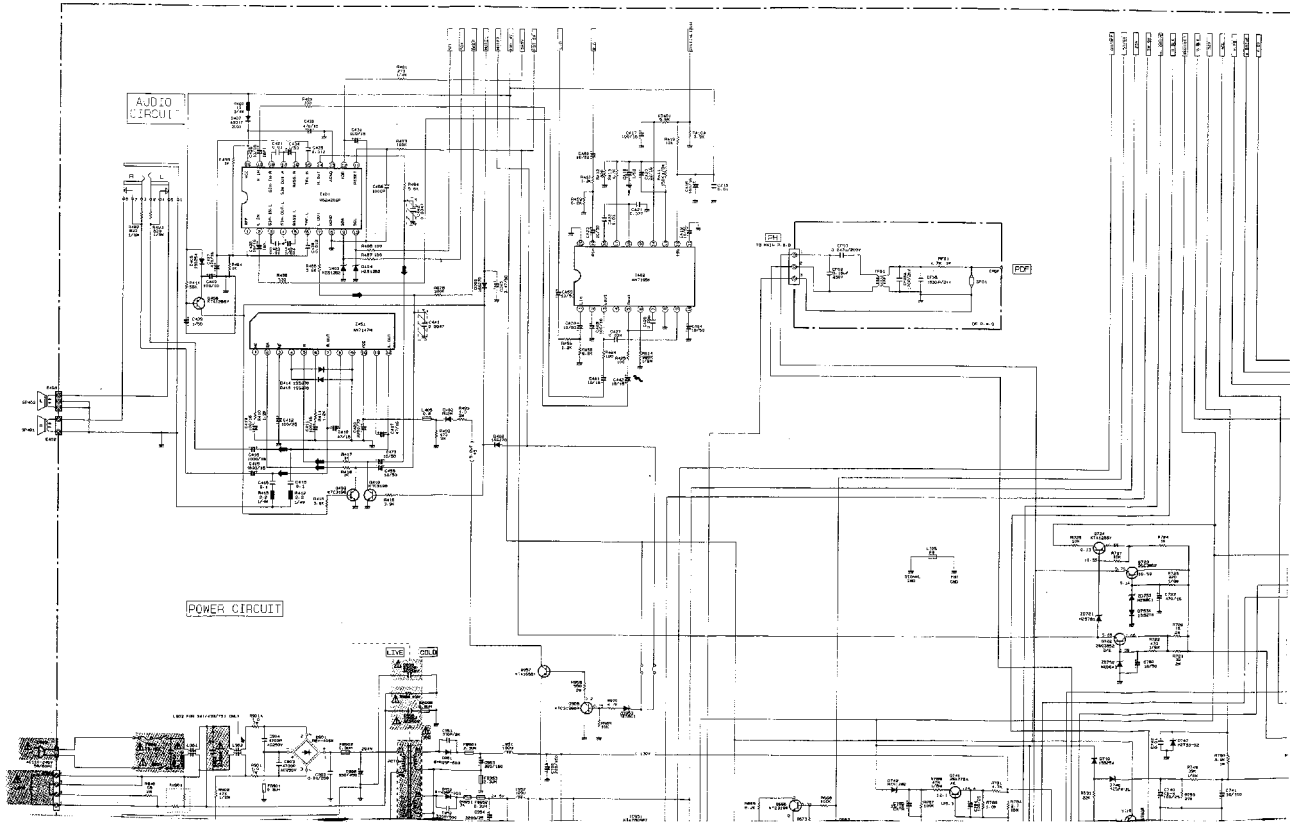

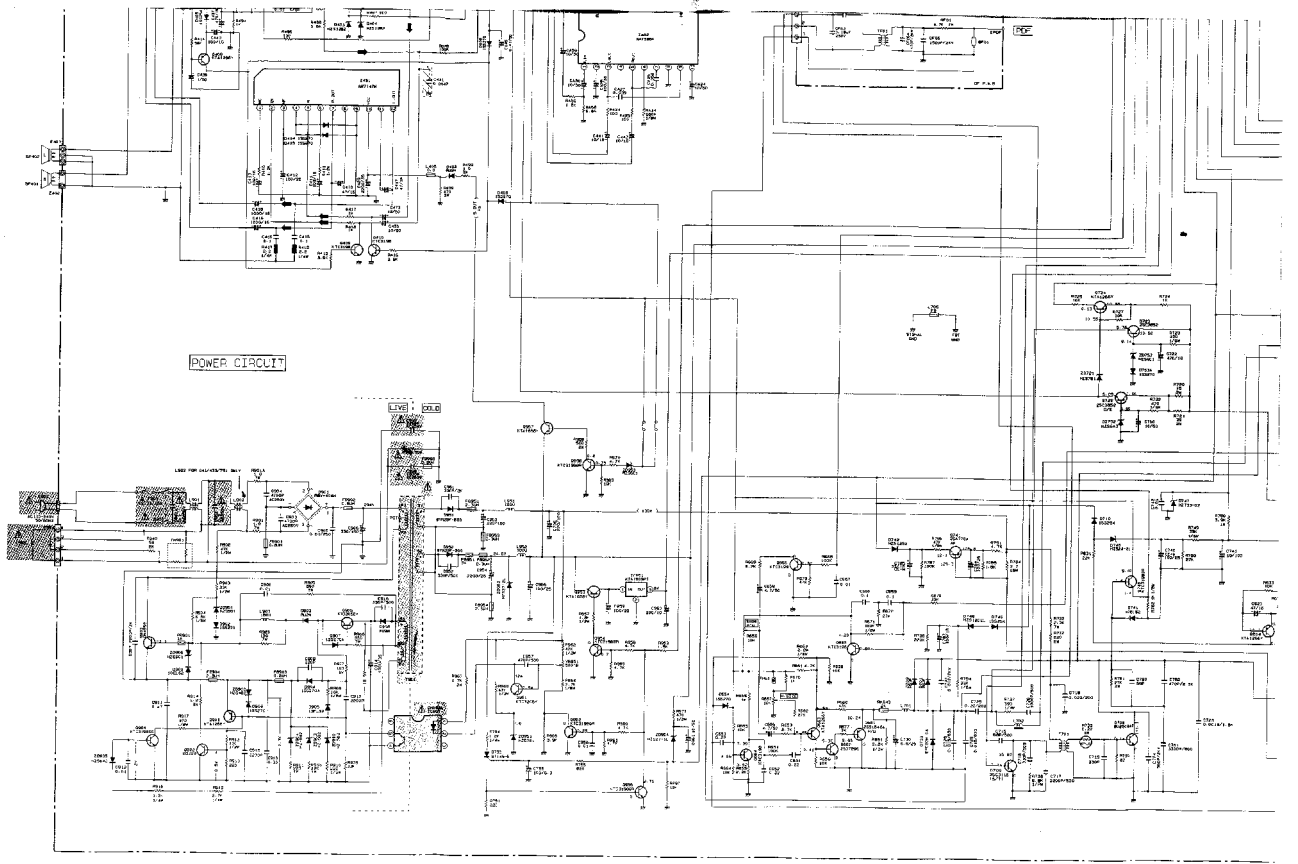

- Shows this is basic circuit of
- All DC voltage to be measured
Voltage taken on a complete

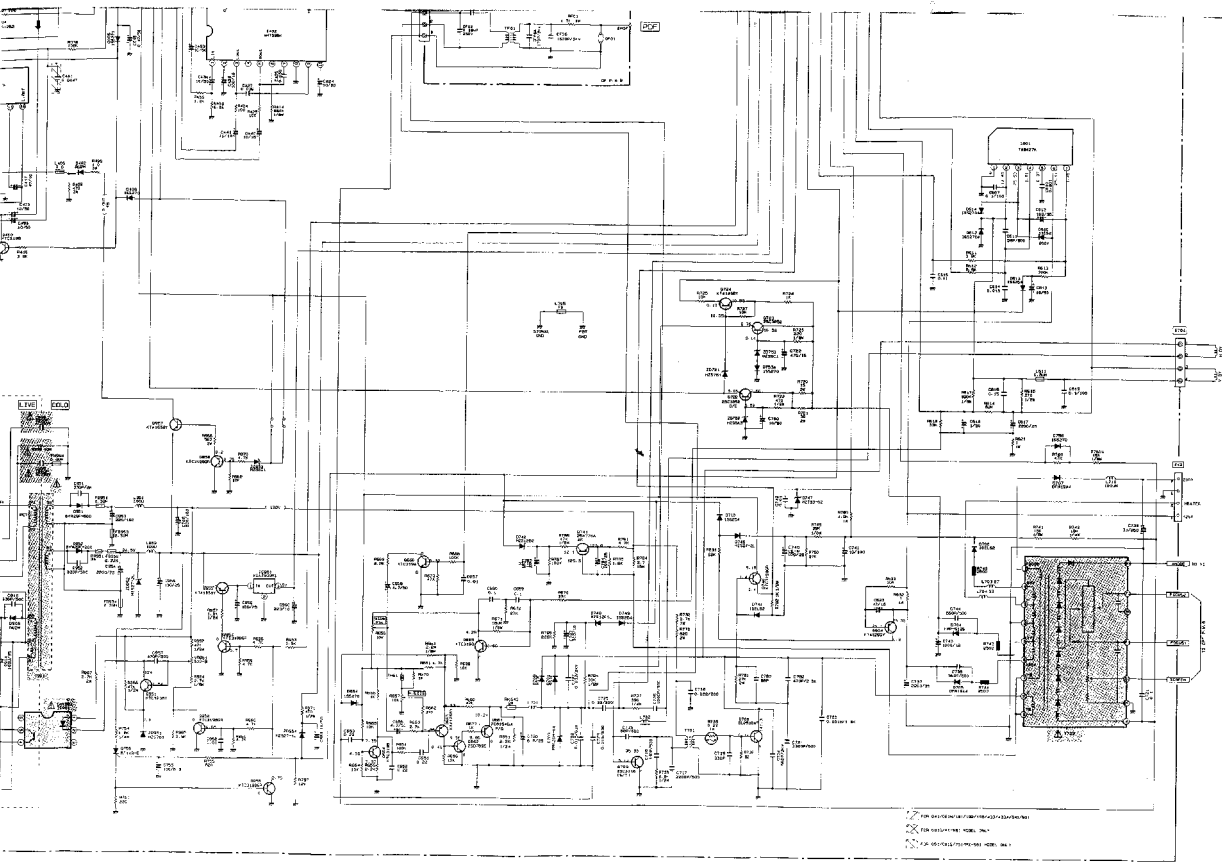

- Since this is basic circuit diagram, the value of the parts is subject to be altered for improvement.
 - All DC voltage to be measured with a lesser (100k Ω).
- Voltage taken on a complex color bar signal including a standard color bar signal.

MAIN P.W.B. (主印刷电路板)

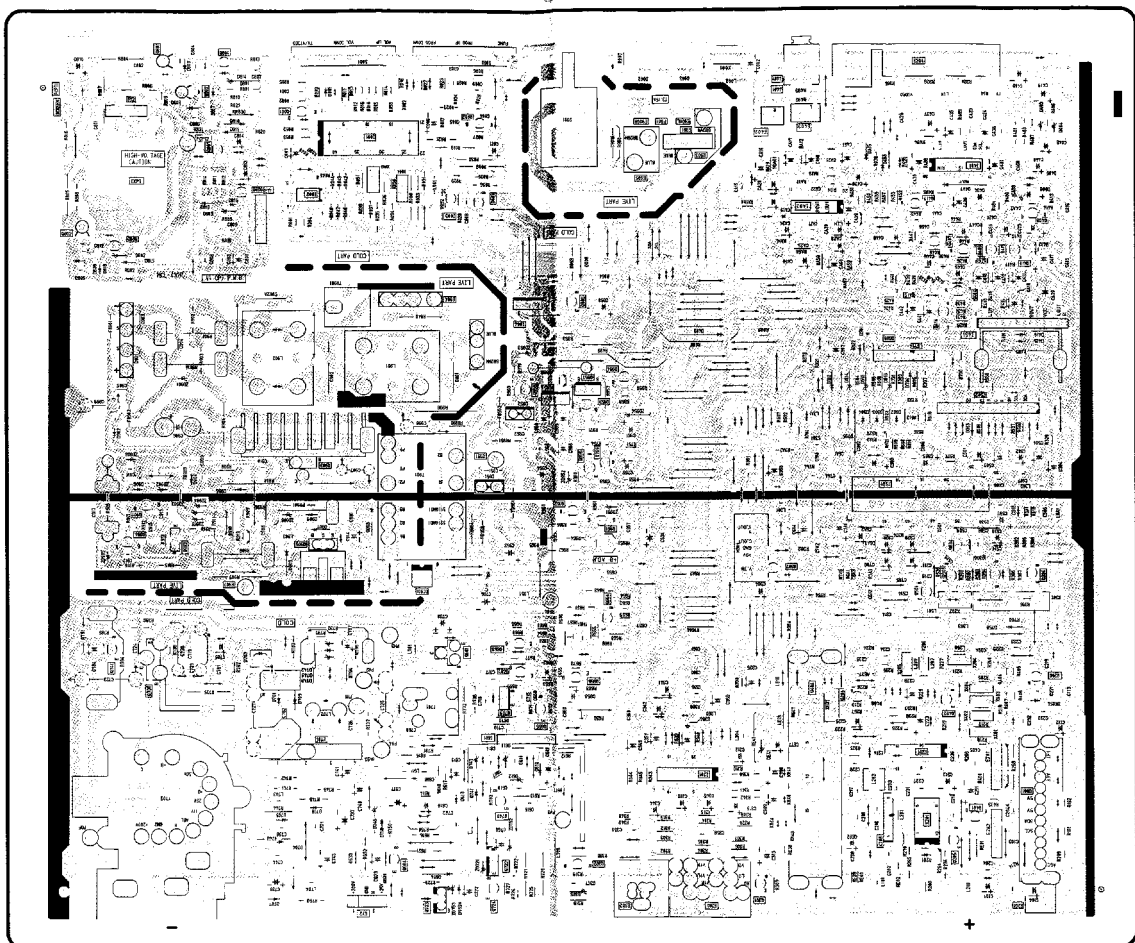

CRT P.W.B.

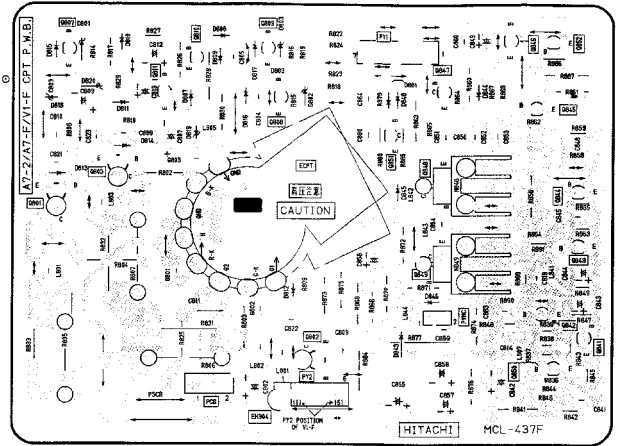

DYNAMIC FOCUS P.W.B.

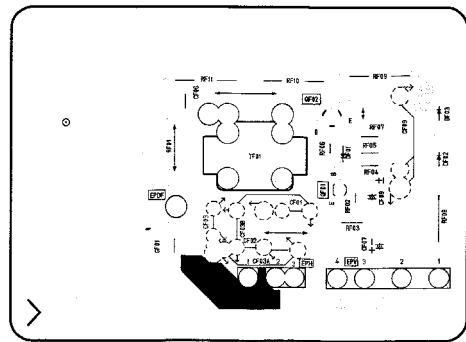

T/TEXT PWB (081S/982 ONLY)

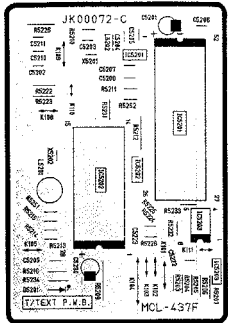

IF SUB PWB

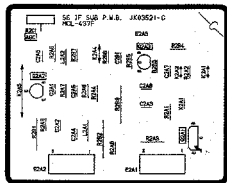

T/TEXT SUB PWB (081S/982 ONLY)

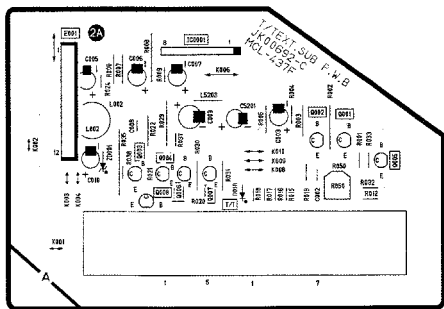

① NO RASTER AND SOUND (故障索引)

① NO RASTER AND SOUND

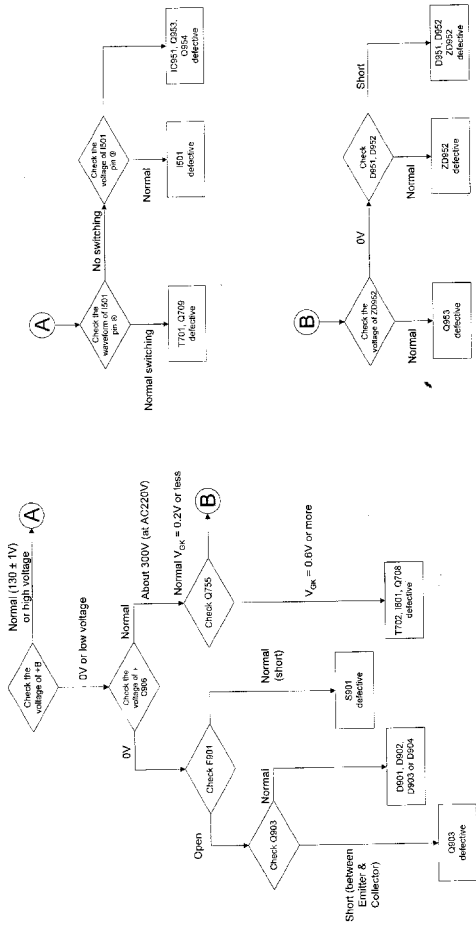

② CHANNEL DISPLAY IS NOT DONE (故障索引)

② CHANNEL DISPLAY IS NOT DONE

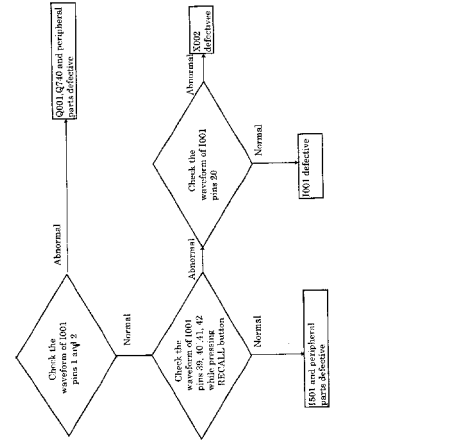

③ CHANNEL SELECTION IS NOT DONE

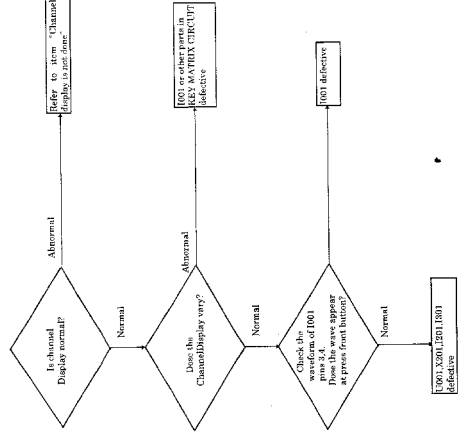

REPLACEMENT PARTS LIST

PRODUCT SAFETY NOTE: Components marked with a Δ have special characteristics important to safety. Before replacing any of these components, read carefully the **PRODUCT SAFETY NOTICE** of this Service Manual. Don't degrade the safety of the receiver through improper servicing.

ABBREVIATIONS Capacitors.....CD: Ceramic Disk, PE: Polyester Film, EL: Electrolytic, PP: Polypropylene, PR: Paper, TA: Tantalum, TM: Timer.
Resistors.....CF: Carbon film, W.W: Wire Wound, FR: Fuse Resistor, MG: Metal Glazed, VR: Variable Resistor, CC: Carbon Composition, MI: Metal Oxide Film.
Semiconductors...TR: Transistor, DI: Diode, ZD: Zener Diode, VA: Varistor, TH: Thermistor.

SYMBOL No.	PART No.	DESCRIPTIONS	SYMBOL No.	PART No.	DESCRIPTIONS
B	JK04241	IF SUB PWB	C224	AN00624R	PF 0.01MF +10% 50V
B	JK05311D	CPT/3D-COMB PWB	C225	0800264R	(Not for NICAM/A2 models) EL 10MF 50V(SMG)
B	JK05651B	DYNAMIC FOCUS PWB	C226	0800277R	EL 0.47MF 50V(SMG)
B001	JK04031J	V1 MAIN BOARD	C227	0244105R	CD 2200PF +10% 50V(B)
C001	AN00631R	PF 0.33MF +10% 50V	C228	0244171R	CD 10000PF 50V(F)
C002	0800048R	EL 100MF 10V(SME)	C232	0244171R	CD 10000PF 50V(F)
C003	0800089R	CC 0.0015MF +10% 50V(B)	C233	0244171R	CD 10000PF 50V(F)
C004	AN00624R	PF 0.01MF +10% 50V	C234	0800074R	CC 100PF +5% 50V(SL)
C005	AN00624R	PF 0.01MF +10% 50V	C235	0800066R	CC 27PF +5% 50V(SL)
C006	0800351R	EL 470MF 6.3V(SMG)	C236	0244105R	CD 2200PF +10% 50V(B)
C007	0800048R	EL 100MF 10V(SME)	C2A1	0244105R	CD 2200PF +10% 50V(B)
C008	0800087R	CC 1000PF +10% 50V(B)	C2A1	0244105R	CD 2200PF +10% 50V(B)
C009	0800074R	CC 100PF +5% 50V(SL)	C2A2	0800063R	CC 15PF +5% 50V(SL)
C011	0800294R	EL 10MF 50V(SMG)	C2A2	0800063R	CC 15PF +5% 50V(SL)
C045	0800277R	EL 0.47MF 50V(SMG)	C2A3	0244171R	CD 10000PF 50V(F)
C050	0800326R	EL 100MF 16V(SMG)	C2A3	0244171R	CD 10000PF 50V(F)
C101	0800326R	EL 100MF 16V(SMG)	C2A4	0244105R	CD 2200PF +10% 50V(B)
C104	0800294R	EL 10MF 50V(SMG)	C2A4	0244105R	CD 2200PF +10% 50V(B)
C112	0800279R	EL 1MF 50V(SMG)	C2A5	0244105R	CD 2200PF +10% 50V(B)
C113	0244171R	CD 10000PF 50V(F)	C2A6	0244105R	CD 2200PF +10% 50V(B)
C202	0244105R	CD 2200PF +10% 50V(B)	C2A6	0244105R	CD 2200PF +10% 50V(B)
C203	0244105R	CD 2200PF +10% 50V(B)	C2A6	0244105R	CD 2200PF +10% 50V(B)
C204	AN00637R	PF 0.1MF +10% 50V	C2A7	0244105R	CD 2200PF +10% 50V(B)
C204A	0680057R	PF 0.1MF +10% 50V (For Nicam/A2 models only)	C2A7	0244105R	CD 2200PF +10% 50V(B)
C208	AN00624R	PF 0.01MF +10% 50V (For Nicam/A2 models only)	C2A8	0244171R	CD 10000PF 50V(F)
C210	0244171R	CD 10000PF 50V(F)	C2B1	0244105R	CD 2200PF +10% 50V(B)
C211	0800276R	EL 1MF 50V(SMG)	C2B1	0244105R	CD 2200PF +10% 50V(B)
C212	0800361F	EL 100MF 16V(SMG)	C301	0244171R	CD 10000PF 50V(F)
C214	AN00628R	PF 0.022MF +10% 50V	C302	0244171R	CD 10000PF 50V(F)
C216	AN00624R	PF 0.01MF +10% 50V	C303	0800047R	EL 100MF 6.3V(SME)
C217	AN00624R	PF 0.01MF +10% 50V	C304	0600015R	EL 10MF 16V(SME)
C218	0244171R	CD 10000PF 50V(F)	C305	0800326R	EL 100MF 16V(SMG)
C219	0244171R	CD 10000PF 50V(F)	C306	0244171R	CD 10000PF 50V(F)
C221	0244171R	CD 10000PF 50V(F)	C307	0800326R	EL 470MF 10V(SMG)
C222	0244171R	CD 10000PF 50V(F)	C310	0800294R	EL 10MF 50V(SMG)
C223	0800282R	EL 2.2MF 50V(SMG)	C311	0800333R	EL 220MF 6.3V(SMG)

制品安全上的注意：在下表附带△标记的机件具备特别的安全特性。要替换这些机件以前请详细阅读这本检修手册中“制品安全上的注意”一书，以避免因检修不当而降低电视机的安全性。

PRODUCT SAFETY NOTE: Components marked with a △ have special characteristics important to safety. Before replacing any of these components, read carefully the PRODUCT SAFETY NOTICE of this Service Manual. Don't degrade the safety of the receiver through improper servicing.

SYMBOL No.	PART No.	DESCRIPTIONS	SYMBOL No.	PART No.	DESCRIPTIONS
C312	0800294R	EL 10MF 50V(SMG)	C429	0880045R	PF 0.012MF +10% 50V
C313	0800353R	EL 470MF 16V(SMG)	C430	0800352R	EL 470MF 10V(SMG)
C314	AN00637R	PF 0.1MF +10% 50V	C431	0800326R	EL 100MF 16V(SMG)
C315	0800294R	EL 10MF 50V(SMG)	C434	0284623R	EL 1MF 50V(SMG)
C317	0244171R	CD 10000PF 50V(F)	C435	0284638R	EL 10MF 16V(BP)
C318	AN00637R	PF 0.1MF +10% 50V	C437	0800353R	EL 470MF 16V(SMG)
C319	0244171R	CD 10000PF 50V(F)	C438	0880045R	PF 0.012MF +10% 50V
C325	0800294R	EL 10MF 50V(SMG)	C439	0800279R	EL 1MF 50V(SMG)
C328	0800288R	EL 4.7MF 50V(SMG)	C440	0800048R	EL 100MF 10V(SME)
C329	0800294R	EL 10MF 50V(SMG)	C455	0800294R	EL 10MF 50V(SMG)
C341	0800294R	EL 10MF 50V(SMG)	C468	0890087R	CC 1000PF +10% 50V(B)
C342	0800294R	EL 10MF 50V(SMG)	C473	0800294R	EL 10MF 50V(SMG)
C343	0800294R	EL 10MF 50V(SMG)	C411	AN00619R	PF 0.0047MF 50V
C344	0800294R	EL 10MF 50V(SMG)	C442	AN00619R	PF 0.0047MF 50V
C345	0800294R	EL 10MF 50V(SMG)	C501	0800279R	EL 1MF 50V(SMG)
C356	0800294R	EL 10MF 50V(SMG)			(For T7text models only)
C357	0800277R	EL 0.47MF 50V(SMG)	C502	0800279R	EL 1MF 50V(SMG)
C358	0244171R	CD 10000PF 50V(F)			(For T7text models only)
C359	0244171R	CD 10000PF 50V(F)	C603	0800279R	EL 1MF 50V(SMG)
C360	0244171R	CD 10000PF 50V(F)			(For T7text models only)
C361	0244171R	CD 10000PF 50V(F)	C504	0800288R	EL 4.7MF 50V(SMG)
C380	0800688R	CC 39PF +5% 50V(SL)	C506	AN00624R	PF 0.01MF +10% 50V
C383	0800299R	EL 22MF 16V(SMG)	C507	0800282R	EL 2.2MF 50V(SMG)
C384	0800326R	EL 100MF 16V(SMG)	C508	AN00637R	PF 0.1MF +10% 50V
C398	0800294R	EL 10MF 50V(SMG)	C509	AN00637R	PF 0.1MF +10% 50V
C399	0800294R	EL 10MF 50V(SMG)	C510	0800047R	EL 100MF 6.3V(SME)
C405	AN00624R	PF 0.01MF +10% 50V	C511	0244171R	CD 10000PF 50V(F)
		(Not for NICAMIA2 models)	C512	AN00624R	PF 0.01MF +10% 50V
C406	0244171R	CD 10000PF 50V(F)	C513	0246442R	CD 12PF +5% 50V(CH)
C407	0244171R	CD 10000PF 50V(F)	C514	AN00628R	PF 0.01MF +10% 50V
C410	0800317R	EL 47MF 16V(SMG)	C515	AN00637R	PF 0.1MF +10% 50V
C411	0800326R	EL 100MF 16V(SMG)	C534	0800607F	EL 2200MF 16V(SME)
C412	0800327R	EL 100MF 25V(SMG)	C607	0279683R	PF 0.1M +10% 100V
C413	0800326R	EL 100MF 16V(SMG)	C610	0890087R	CC 1000PF +10% 50V(B)
C415	AN00637R	PF 0.1MF +10% 50V	C611	0247848R	CD 56PF +5% 500V(SL)
C416	AN00637R	PF 0.1MF +10% 50V	C612	0247848R	CD 56PF +5% 500V(SL)
C417	0800317R	EL 47MF 16V(SMG)	C618	0800052R	EL 100MF 35V(SME)
C418	0800361N	EL 1000MF 16V(SMG)	C619	0800294R	EL 10MF 50V(SMG)
C419	0800361N	EL 1000MF 16V(SMG)	C614	AN00628R	PF 0.015MF +10% 50V
C420	0255011F	EL 2200MF 35V(KME)	C615	AN00624R	PF 0.01MF +10% 50V
C421	AN00624R	PF 0.01MF +10% 50V	C616	AN00624R	PF 0.01MF +10% 50V
C423	AN00624R	PF 0.01MF +10% 50V	C617	0800368F	EL 2200MF 25V(SMG)
C424	0284623R	EL 1MF 50V(BP)	C618	0800003R	EL 1MF 50V(SME)
C426	0284638R	EL 10MF 16V(BP)	C619	0279693R	PF 0.1M +10% 100V
			C623	0800317R	EL 47MF 16V(SMG)

SYMBOL No.	PART No.	DESCRIPTIONS	SYMBOL No.	PART No.	DESCRIPTIONS
C651	0880018R	PF 0.22MF +10% 50V	C7A1	0800058R	EL 220MF 16V(SME)
C652	0880018R	PF 0.22MF +10% 50V	C7A2	0244171R	CD 10000PF 50V(F)
C653	0880018R	PF 0.22MF +10% 50V	C7A3	AN00624R	PF 0.01MF +10% 50V
C655	0800288R	EL 4.7MF 50V(SMG)	C7A4	AN00624R	PF 0.01MF +10% 50V
C657	AN00624R	PF 0.01MF +10% 50V	C7A5	AN00624R	PF 0.01MF +10% 50V
C658	0800288R	EL 4.7MF 50V(SMG)	C7A6	0800279R	EL 1MF 50V(SMG)
C659	AN00637R	PF 0.1MF +10% 50V	C802	AL00027R	EL 4.7MF 250V
C660	AN00637R	PF 0.1MF +10% 50V	C803	0890083R	CC 470PF +10% 50V(B)
C6A1	0800279R	EL 1MF 50V(SMG)	C804	0890083R	CC 470PF +10% 50V(B)
C6A2	0292718F	TA 2.2MF 20V	C805	0890083R	CC 470PF +10% 50V(B)
C6A3	AN00637R	PF 0.1MF +10% 50V	C807	0800321R	EL 47MF 50V(SMG)
C6A4	0800279R	EL 1MF 50V(SMG)	C808	0244171R	CD 10000PF 50V(F)
C6A7	0890087R	CC 1000PF +10% 50V(B)	C809	0244171R	CD 10000PF 50V(F)
C706	0253862F	EL 220MF 160V	C810	0244171R	CD 10000PF 50V(F)
C715	0247850R	CD 68PF +5% 500V(SL)	C811	AJ00559	CC 2200PF +10% 2KV
C716	0243507R	CD 330PF +10% 500V(B)	C814	0890065R	CC 22PF +5% 50V(SL)
C717	0244505R	CD 2200PF +10% 500V(B)	C819	0890076R	CC 150PF +5% 50V(SL)
C718	0299918F	PF 0.022MF +10% 200V	C821	0890087R	CC 1000PF +10% 50V(B)
C719	0890081R	CC 330PF +10% 50V(B)	C822	0890087R	CC 1000PF +10% 50V(B)
C721	AN00637R	PF 0.1MF +10% 50V	C823	0890087R	CC 1000PF +10% 50V(B)
C722	0800353R	EL 470MF 16V(SMG)	C841	0880044R	PF 0.01MF +10% 50V
C723	0262407F	PF 0.0018MF 1.8KV	C842	0800076F	EL 470MF 35V(SME)
C724	0244722	CD 560PF +10% 2KV(B)	C843	0800317R	EL 47MF 16V(SMG)
C725	0299930F	PF 0.22MF +10% 200V	C844	0800326R	EL 100MF 16V(SMG)
C726	0244501R	CD 1000PF +10% 500V(B)	C845	0890119R	CC 27PF +5% 50V(CH)
C727	AN01068F	PF 0.012MF 2KV	C848	0890083R	CC 470PF +10% 50V(B)
C728	0289720F	PF 0.015MF 630V	C849	0800319R	EL 47MF 35V(SMG)
C729	0289720F	PF 0.015MF 630V	C850	0890074R	CC 100PF +5% 50V(SL)
C730	0259474	EL 68MF 25V(BP)	C851	0890074R	CC 100PF +5% 50V(SL)
C737	0284442	EL 2200MF 35V	C852	AJ00001R	CC 0.01MF +80%-20% 500V
C738	0243510R	CD 560PF +10% 500V(B)	C853	0244509R	CD 4700PF +10% 500V(B)
C739	0253974F	EL 33MF 250V	C854	AJ00001R	CC 0.01MF +80%-20% 500V
C740	0800327R	EL 100MF 25V(SMG)	C855	0253959F	EL 47MF 160V
C741	0800021R	EL 10MF 100V(SME)	C856	0800321R	EL 47MF 50V(SMG)
C742	AN00624R	PF 0.01MF +10% 50V	C857	0800321R	EL 47MF 50V(SMG)
C743	0800361F	EL 1000MF 16V(SMG)	C858	0253957F	EL 22MF 160V
C744	0243510R	CD 560PF +10% 500V(B)	C859	0247848R	CD 56PF +5% 500V(SL)
C755	0800047R	EL 100MF 6.3V(SME)	C860	0890057R	PF 0.1MF +10% 50V
C760	0800294R	EL 10MF 50V(SMG)	C860	0890074R	CC 100PF +5% 50V(SL)
C780	0890071R	CC 56PF +5% 50V(SL)	C863	0890079R	CC 270PF +10% 50V(B)
C781	0244507R	CD 3300PF +10% 500V(B)	△C901A	AN00144S	PF 0.1MF 250V
C782	0244202F	CD 470PF +10% 2KV(R)	C902	AN00144S	PF 0.1MF 250V
C784	0800327R	EL 100MF 25V(SMG)	C903	0248593F	CD 4700PF +80%-20% 250V(F)
C785	0800308R	EL 33MF 16V(SMG)	C904	0248593F	CD 4700PF +80%-20% 250V(F)
C787	0800326R	EL 100MF 16V(SMG)	C905	0248594F	CD 0.01MF +80%-20% 250V(F)

制品安全上的注意: 在下表附带△标记的机件具备特别的安全性。要替换这些机件以前请详细阅读这检修手册中“制品安全上的注意”一书, 以避免因检修不当而降低电视机的安全性。

PRODUCT SAFETY NOTE: Components marked with a △ have special characteristics important to safety. Before replacing any of these components, read carefully the PRODUCT SAFETY NOTICE of this Service Manual. Don't degrade the safety of the receiver through improper servicing.

SYMBOL No.	PART No.	DESCRIPTIONS	SYMBOL No.	PART No.	DESCRIPTIONS
	C906	AL00095		CF06	0244212
	C907	0244215		CF06A	0244202F
	C908	AN00624R		D001	2338321M
	C909	080075R		D002	CH00231A
	C910	080005R		D003	CH00232
	C911	0270743R		D006	2338321M
	C912	AN00624R		D201	2338321M
	C913	0270741R		D301	2338321M
	C914	0284436R		D302	2338321M
	C915	080005R		D303	2338321M
	C916	0243507R		D304	2338321M
	C951	0244718		D305	2339869M
	C952	0243507R		D306	2339869M
	C953	AL00911		D312	2338321M
	C954	0800368N		D313	2338321M
	C956	0800327R		D402	2333001M
	C957	0243509R		D403	2339885M
	C958	AN00624R		D404	2339885M
	C959	0800327R		D405	234041M
	C960	0800334R		D407	2339481M
	C961	0800294R		D408	2338321M
△	C968	AJ00601		D414	2338321M
△	C969	AJ00603		D415	2338321M
	CA15	AN00824R		D514	2339869M
	CA16	0800326R		D515	2339869M
	CA17	0800326R		D516	2339869M
	CA18	0800279R		D610	CH00681M
	CA19	0800294R		D612	2337341M
	CA20	0800299R		D613	234041M
	CA21	080049R		D614	2337341M
	CA22	AN00624R		D654	2338321M
	CA23	0800294R		D701	2348511
	CA24	0800294R		D703	2340471
	CA25	0800054R		D704	2359401
	CA27	0800052R		D705	2339802M
	CA29	0800326R		D706	CH00711M
	CA30	0800294R		D707	2339802M
	CA59	0800294R		D709	2348511
	CA60	0800294R		D710	234041M
	CE77	0800048R		D741	CH00711M
	CE82	0800048R		D742	2339885M
	CF02	0289923F		D746	2339212M
	CF03	0289922F		D747	2335991M
				D748	2339151M
				D749	2344041M

SYMBOL No.	PART No.	DESCRIPTIONS	SYMBOL No.	PART No.	DESCRIPTIONS
	D753A	2338321M		E903	2972591A
	D758	2338321M		E903	2972591K
	D794	2338321M		E903	2972581A
	D795	2338321M		E903	2972581A
	D801	2339051M		E903	2972554/5
	D802	2339051M		E903	2972554/5
	D803	2339051M		E903	EV00001
	D812	2344041M		E903	EV00001A
	D813	2344041M		E903	EV00001C
	D814	2344041M		E904	2903544
	D818	2339881M		E905	EK00901
	D819	2339881M		E906L	2728252BR
	D820	2339881M		E906R	2728252BR
	D843	2339491M		E907	2903547
	D844	2339491M		E91	2903547
	D845	2339491M		ECPT	EY00413
	D846	2339491M		EH304	EF09012
	D848	234041M		EPDF	2903547
	D901	233831A		EPH	2903543
	D902	2338321M		EY1	EF06413
	D903	2333001M		EY2	EF06412
	D904	2337341M		F901	2721615
	D905	CH00711M		F901	2123468M
	D906	2338321M		F902	2123468M
	D907	2337341M		F903	2123468M
	D908	2333001M		F904	2123462M
	D909	CH00711M		F961	2123462M
	D951	2349983		F982	2123462M
	D952	2349981		F983	2123462M
	DE41	2339862M		F994	2123462M
				F998	2123468M
	DK054	2338321M		G801	CJ00071R
	E201	2122652M		G802	CJ00071R
	E201	2774731R		G803	CJ00071R
	E2A1	ED00363		GF01	CJ00072R
	E2A1	ED00363		H301	HP00151
	E2A2	ED00363		H304	2903547
	E2A2	ED00363		I001	CP04801U
	E301	2693884		I002	CP03981
	E302	2693853			
	E304	EU00582			
	E402	2723101J			
	E403	2723102J			
	E502	2802269			
	E701	2665272			

1002(Memory IC) needs to be programmed by factory before placement. As different programmes are for different models, servicemen please indicate the model name and destination code when purchase this part to ensure correct programme provided.
e.g. CP03981 IC S24C08A(C29-F100-051)

制品安全上的注意: 在下表附带△标记的机件具备特别的安全特性。要替换这些机件以前请详细阅读这检修手册中“制品安全上的注意”一书, 以避免因检修不当而降低电视机的安全性。

PRODUCT SAFETY NOTICE: Components marked with a △ have special characteristics important to safety. Before replacing any of these components, read carefully the PRODUCT SAFETY NOTICE of this Service Manual. Don't degrade the safety of the receiver through improper servicing.

SYMBOL No.	PART No.	DESCRIPTIONS	SYMBOL No.	PART No.	DESCRIPTIONS
I003	CP02871R	TRS IC KIA7042P	L842	2123468M	FERRITE BEADS B 0.8 MH
I004	CP02411	IC KIA7805PI	L843	2123468M	FERRITE BEADS B 0.8 MH
I201	CP03771	IC LA7566	L844	2123468M	FERRITE BEADS B 0.8 MH
I301	CP04971	IC MM1250XD	△ L901	BZ02121	LINE FILTER
I401	CP01831	IC M62420SP	△ L902	BZ02122	LINE FILTER - 041/433/751 only
I451	2004022	IC AN7147N	L903	BH00737R	CHOKE COIL 180MH
I501	CP03791U	IC TB1225AN	L905	2276065	DEGAUSSING COIL
I601	CP03651	IC TA8427K	L951	BH00734R	PEAKING COIL 100MH
I601	CP03651	IC AN7385K	L952	BH00734R	PEAKING COIL 100MH
△ IC901	2917785	IC CNX82A 300	LE13	2123461M	FERRITE BEADS B 0.8 MH
IC951	CP04771	IC KIA7809P	LE16	2123781R	PEAKING COIL 100MH +10%
J401	2672041	HEADPHONE JACK	LE39	2123103M	AXIAL COIL 10MH +10%
L001	2123461M	FERRITE BEADS B 0.8 MH			(For NICAM/A2 models only)
L002	2123461M	FERRITE BEADS B 0.8 MH	LE40	2123103M	AXIAL COIL 10MH +10%
L101	2123781R	PEAKING COIL 100MH +10%	PCG	2903542	2P PLUG PIN W/BASE
L201	2123415M	AXIAL COIL 2.2MH +10%	PR901	AZ00102M	1A PROTECTOR
		(Not for NICAM/A2 models)	PR951	AZ00106M	3A PROTECTOR
L203	BH00614	VCO COIL 38.9MHZ	PVMC	2902251	2P MINI PLUG PIN W/BASE
L207	2123104M	AXIAL COIL 12MH +10%	PY1	ED00386	CP-07BP2R5V LOCK
L208	2123102M	AXIAL COIL 8.2MH +10%	PY2	ED00384	6P CONNECTOR BASE
L209	2123103M	AXIAL COIL 10MH +10%	Q001	CF01421R	TRS. KTC3198 GR
L210	2123461M	FERRITE BEADS B 0.8 MH	Q002	CF01421R	TRS. KTC3198 GR
L2A1	2123412M	AXIAL COIL 1.2MH +10%	Q204	CF01431R	TRS. KTA 1266Y
L2A2	2123412M	AXIAL COIL 1.2MH +10%	Q205	2326872R	TRS. DTC114ES
L2A2	2123415M	AXIAL COIL 2.2MH +10%	Q206	2326872R	TRS. DTC114ES
L2A2	2123415M	AXIAL COIL 2.2MH +10%	Q2A1	2326872R	TRS. DTC114ES
L301	2123781R	PEAKING COIL 100MH +10%	Q2A2	2320144M	TRS. 25C1906
L302	2123781R	PEAKING COIL 100MH +10%	Q2A3	2320144M	TRS. 25C1906
L303	2123781R	PEAKING COIL 100MH +10%	Q2A3	2320144M	TRS. 25C1906
L304	2123781R	PEAKING COIL 100MH +10%	Q2A3	2320144M	TRS. 25C1906
L380	2122946M	AXIAL COIL 33MH +10%	Q301	CF01421R	TRS. KTC3198 GR
L405	2123461M	FERRITE BEADS B 0.8 MH	Q302	2326872R	TRS. DTC114ES
L501	2123781R	PEAKING COIL 100MH +10%	Q303	CF01431R	TRS. KTA 1266Y
L511	BH00205R	HIGH FREQ. INDUCTOR 22UH	Q304	CF01431R	TRS. KTA 1266Y
L6A1	2123781R	PEAKING COIL 100MH +10%	Q306	CF01431R	TRS. KTA 1266Y
L701	2124183	CHOKE COIL	Q306	CF01431R	TRS. KTA 1266Y
L702	BZ01391	LINEARITY COIL 27MH	Q401	CF01421R	TRS. KTC3198 GR
L703	2125763R	RADIAL COIL 27MH			(Not for NICAM/A2 models)
L704	2125808N	COIL 68MH	Q402	CF01421R	TRS. KTC3198 GR
L705	2123461M	FERRITE BEADS B 0.8 MH			(For NICAM/A2 models only)
L710	BH00214R	FILTER COIL 100MH	Q408	CF01431R	TRS. KTA 1266Y
L7A1	2123781R	PEAKING COIL 100MH +10%	Q409	CF01421R	TRS. KTC3198 GR
L805	2123781R	PEAKING COIL 100MH +10%	Q410	CF01421R	TRS. KTC3198 GR
L807	2122943M	AXIAL COIL 10MH +10%			
L841	2122937M	AXIAL COIL 3.9MH +10%			

SYMBOL No.	PART No.	DESCRIPTIONS	SYMBOL No.	PART No.	DESCRIPTIONS
Q501	2326873R	TRS. DTC144ES	Q958	CF01421R	TRS. KTC3198 GR
Q604	CF01431R	TRS. KTA 1266Y	R001	0700056M	CF 15K OHM +5% 1/16W
Q661	2315933	TRS. 25B1548A-P/Q	R002	0700041M	CF 1K OHM +5% 1/16W
Q662	2323522M	TRS. 2SD789E	R003	0700051M	CF 5.8K OHM +5% 1/16W
Q663	CF01431R	TRS. KTA 1266Y	R004	0700054M	CF 10K OHM +5% 1/16W
Q654	CF01421R	TRS. KTC3198 GR	R005	0700055M	CF 12K OHM +5% 1/16W
Q655	CF01421R	TRS. KTC3198 GR	R006	0700041M	CF 1K OHM +5% 1/16W
Q686	CF01421R	TRS. KTC3198 GR	R007	0700043M	CF 1.5K OHM +5% 1/16W
Q708	2315451	TRS. BU2508AF	R009	0700054M	CF 10K OHM +5% 1/16W
Q709	2326216	TRS. 2SC3116 S/T	R010	0700043M	CF 1.5K OHM +5% 1/16W
Q722	2312171	TRS. 2SC3852	R011	0700058M	CF 22K OHM +5% 1/16W
Q723	2312171	TRS. 2SC3852	R012	0700054M	CF 10K OHM +5% 1/16W
Q724	CF01431R	TRS. KTA 1266Y	R013	0700058M	CF 22K OHM +5% 1/16W
Q740	CF01421R	TRS. KTC3198 GR	R014	0700045M	CF 2.2K OHM +5% 1/16W
Q741	2321112M	TRS. BT478AK-02	R015	0700045M	CF 2.2K OHM +5% 1/16W
Q755	CJ00161R	TRS. BT149-B	R016	0700027M	CF 100 OHM +5% 1/16W
Q801	CF01841F	TRS. 25C4075 D/E	R017	0700047M	CF 3.3K OHM +5% 1/16W
Q802	CF01841F	TRS. 25C4075 D/E	R018	0700041M	CF 1K OHM +5% 1/16W
Q803	CF01841F	TRS. 25C4075 D/E	R019	0700041M	CF 1K OHM +5% 1/16W
Q807	2320663M	TRS. 25C1213AC	R020	0700053M	CF 8.2K OHM +5% 1/16W
Q808	2320663M	TRS. 25C1213AC	R021	0700041M	CF 1K OHM +5% 1/16W
Q809	2320663M	TRS. 25C1213AC	R022	0700054M	CF 10K OHM +5% 1/16W
Q841	2312941M	TRS. 25C3413BC/1740S Q/R	R023	0700062M	CF 39K OHM +5% 1/16W
Q842	2312941M	TRS. 25C3413BC/1740S Q/R	R024	0700062M	CF 39K OHM +5% 1/16W
Q843	2312941M	TRS. 25C3413BC/1740S Q/R	R025	0700067M	CF 100K OHM +5% 1/16W
Q844	2312941M	TRS. 25C3413BC/1740S Q/R	R026	0700067M	CF 100K OHM +5% 1/16W
Q845	2312941M	TRS. 25C3413BC/1740S Q/R	R027	0700056M	CF 5.6K OHM +5% 1/16W
Q846	2327783M	TRS. 25C3553 C/D	R028	0700051M	CF 15K OHM +5% 1/16W
Q847	2321351M	TRS. 25A836/844D/E	R029	0700041M	CF 1K OHM +5% 1/16W
Q848	CF02231	TRS. 25A1606E	R030	0700027M	CF 100 OHM +5% 1/16W
Q849	CF02241	TRS. 25C4159E	R031	0700058M	CF 22K OHM +5% 1/16W
Q850	2312941M	TRS. 25C3413BC/1740S Q/R	R032	0700041M	CF 1K OHM +5% 1/16W
Q851	2312941M	TRS. 25C3413BC/1740S Q/R	R033	0700056M	CF 15K OHM +5% 1/16W
Q852	2320663M	TRS. 25A673 C/D	R034	0700027M	CF 100 OHM +5% 1/16W
Q901	CF01431R	TRS. KTA 1266Y	R035	0700027M	CF 100 OHM +5% 1/16W
Q902	CF01221	TRS. BD329	R036	0700041M	CF 1K OHM +5% 1/16W
Q903	2314792	TRS. BUT12AF/ON4959	R037	0700041M	CF 1K OHM +5% 1/16W
Q904	CF01421R	TRS. KTC3198 GR	R038	0700041M	CF 1K OHM +5% 1/16W
Q905	CF01831	TRS. KTD2058Y	R039	0700027M	CF 100 OHM +5% 1/16W
Q951	CF01821R	TRS. KTC3206Y	R040	0700027M	CF 100 OHM +5% 1/16W
Q952	CF01421R	TRS. KTC3198 GR	R042	0700041M	CF 1K OHM +5% 1/16W
Q953	CF01851	TRS. KTA 1658Y	R043	0700046M	CF 2.7K OHM +5% 1/16W
Q954	CF01421R	TRS. KTC3198 GR	R044	0700046M	CF 2.7K OHM +5% 1/16W
Q955	CF01421R	TRS. KTC3198 GR	R045	0700046M	CF 2.7K OHM +5% 1/16W
Q957	CF01851	TRS. KTA 1658Y	R046	0700046M	CF 2.7K OHM +5% 1/16W

制品安全上的注意: 在下表附带△标记的机件具备特别的安全性。要替换这些机件以前请详细阅读该检修手册中“制品安全上的注意: 一书, 以避免因检修不当而降低电视机的安全性。

PRODUCT SAFETY NOTE: Components marked with a △ have special characteristics important to safety. Before replacing any of these components, read carefully the PRODUCT SAFETY NOTICE of this Service Manual. Don't degrade the safety of the receiver through improper servicing.

SYMBOL No.	PART No.	DESCRIPTIONS	SYMBOL No.	PART No.	DESCRIPTIONS
R041	0700046M	CF 2.7K OHM +5% 1/16W	R2A3	0700058M	CF 22K OHM +5% 1/16W
R048	0700046M	CF 2.7K OHM +5% 1/16W	R2A3	0700058M	CF 22K OHM +5% 1/16W
R050	0700043M	CF 1.5K OHM +5% 1/16W	R2A4	0700023M	CF 47 OHM +5% 1/16W
R051	0700043M	CF 1.5K OHM +5% 1/16W	R2A4	0700023M	CF 47 OHM +5% 1/16W
R052	0700051M	CF 5.6K OHM +5% 1/16W	R2A5	0700045M	CF 2.2K OHM +5% 1/16W
R053	0700051M	CF 5.6K OHM +5% 1/16W	R2A5	0700045M	CF 2.2K OHM +5% 1/16W
R055	0700041M	CF 1K OHM +5% 1/16W	R2A6	0700051M	CF 5.6K OHM +5% 1/16W
R056	0700041M	CF 1K OHM +5% 1/16W	R2A6	0700051M	CF 5.6K OHM +5% 1/16W
R057	0700051M	CF 5.6K OHM +5% 1/16W	R2A7	0700044M	CF 1.8K OHM +5% 1/16W
R078	0700067M	CF 100K OHM +5% 1/16W	R2A7	0700044M	CF 1.8K OHM +5% 1/16W
R095	0700027M	CF 100 OHM +5% 1/16W	R2A8	0700037M	CF 560 OHM +5% 1/16W
R101	0700023M	CF 47 OHM +5% 1/16W	R2A8	0700037M	CF 560 OHM +5% 1/16W
R102	0700023M	CF 47 OHM +5% 1/16W	R2A8	0700037M	CF 560 OHM +5% 1/16W
R205	0700045M	CF 2.2K OHM +5% 1/16W	R2A9	0700019M	CF 15 OHM +5% 1/16W
R208	0700041M	CF 1K OHM +5% 1/16W	R2A9	0700019M	CF 15 OHM +5% 1/16W
R209	0700065M	CF 68K OHM +5% 1/16W	R2B1	0700027M	CF 100 OHM +5% 1/16W
R213	0700037M	CF 560 OHM +5% 1/16W	R2B2	0114135M	CF 150 OHM +5% 1/4W
R214	0700056M	CF 15K OHM +5% 1/16W	R2B2	0114135M	CF 150 OHM +5% 1/4W
R216	0700045M	CF 2.2K OHM +5% 1/16W	R2B3	0700051M	CF 5.6K OHM +5% 1/16W
R217	0700045M	CF 2.2K OHM +5% 1/16W	R2B3	0700051M	CF 5.6K OHM +5% 1/16W
R218	0700054M	CF 10K OHM +5% 1/16W	R2B4	0700045M	CF 2.2K OHM +5% 1/16W
R219	0700027M	CF 100 OHM +5% 1/16W	R2B4	0700045M	CF 2.2K OHM +5% 1/16W
		(For NICAM/A2 models only)	R2B5	0700014M	CF 10 OHM +5% 1/16W
R221	0700031M	CF 180 OHM +5% 1/16W	R2B5	0700014M	CF 10 OHM +5% 1/16W
R223	0700063M	CF 47K OHM +5% 1/16W	R2B6	0700027M	CF 100 OHM +5% 1/16W
R224	0700037M	CF 560 OHM +5% 1/16W	R2B6	0700027M	CF 100 OHM +5% 1/16W
R225	0700041M	CF 1K OHM +5% 1/16W	R2B7	0700032M	CF 220 OHM +5% 1/16W
R226	0700062M	CF 39K OHM +5% 1/16W	R2B7	0700032M	CF 220 OHM +5% 1/16W
R227	0700033M	CF 270 OHM +5% 1/16W	R2B8	0114135M	CF 150 OHM +5% 1/4W
R228	0700037M	CF 560 OHM +5% 1/16W	R2B8	0114135M	CF 150 OHM +5% 1/4W
R229	0700036M	CF 470 OHM +5% 1/16W	R2C1	0150308	VR 20K OHM(B)
R234	0700041M	CF 1K OHM +5% 1/16W	R2C1	0150308	VR 20K OHM(B)
R235	0700037M	CF 560 OHM +5% 1/16W	R302	0100038M	CF 75 OHM +5% 1/18W
R237	0187058M	CF 510 OHM +5% 1/16W	R303	0100041M	CF 100 OHM +5% 1/18W
R238	0700039M	CF 820 OHM +5% 1/16W	R304	0100113M	CF 100K OHM +5% 1/18W
R240	0700038M	CF 680 OHM +5% 1/16W	R305	0100041M	CF 100 OHM +5% 1/18W
R264	0700041M	CF 1K OHM +5% 1/16W	R306	0100105M	CF 47K OHM +5% 1/18W
R265	0700047M	CF 3.3K OHM +5% 1/16W	R307	0100041M	CF 100 OHM +5% 1/18W
R266	0700054M	CF 10K OHM +5% 1/16W	R308	0100037M	CF 56 OHM +5% 1/18W
R267	0700063M	CF 47K OHM +5% 1/16W	R309	0100045M	CF 150 OHM +5% 1/18W
R268	0700061M	CF 33K OHM +5% 1/16W	R310	0700027M	CF 100 OHM +5% 1/18W
R2A1	0700014M	CF 10 OHM +5% 1/16W	R312	0100113M	CF 100K OHM +5% 1/18W
R2A1	0700014M	CF 10 OHM +5% 1/16W	R313	0100041M	CF 100 OHM +5% 1/18W
R2A2	0700025M	CF 68 OHM +5% 1/16W	R314	0100105M	CF 47K OHM +5% 1/18W
R2A2	0700025M	CF 68 OHM +5% 1/16W	R315	0100041M	CF 100 OHM +5% 1/18W

SYMBOL No.	PART No.	DESCRIPTIONS	SYMBOL No.	PART No.	DESCRIPTIONS
R318	0100038M	CF 75 OHM +5% 1/18W	R405	0700034M	CF 330 OHM +5% 1/16W (Not for NICAM/A2 models)
R319	0100041M	CF 100 OHM +5% 1/18W	R406	0700034M	CF 330 OHM +5% 1/16W (Not for NICAM/A2 models)
R320	0100113M	CF 100K OHM +5% 1/18W	R407	0700034M	CF 330 OHM +5% 1/16W (Not for NICAM/A2 models)
R321	0700058M	CF 22K OHM +5% 1/18W	R408	0700041M	CF 1K OHM +5% 1/16W (For NICAM/A2 models only)
R322	0700056M	CF 15K OHM +5% 1/18W			
R324	0100129M	CF 470K OHM +5% 1/18W	R409	0110337S	MF 470 OHM +5% 3W
R326	0100129M	CF 470K OHM +5% 1/18W	R410	0700042M	CF 1.2K OHM +5% 1/16W
R329	0700049M	CF 4.7K OHM +5% 1/16W	R411	0700042M	CF 1.2K OHM +5% 1/16W
R330	0700027M	CF 100 OHM +5% 1/18W	R412	0119505G	MG 2.2 OHM +5% 1/4W
R335	0700054M	CF 10K OHM +5% 1/16W	R413	0119505G	MG 2.2 OHM +5% 1/4W
R340	0700027M	CF 100 OHM +5% 1/18W	R414	0700064M	CF 56K OHM +5% 1/16W
R341	0700027M	CF 100 OHM +5% 1/18W	R415	0700048M	CF 3.9K OHM +5% 1/16W
R342	0700027M	CF 100 OHM +5% 1/18W	R416	0700048M	CF 3.9K OHM +5% 1/16W
R343	0100041M	CF 100 OHM +5% 1/18W	R417	0700041M	CF 1K OHM +5% 1/16W
R344	0100041M	CF 100 OHM +5% 1/18W	R418	0700041M	CF 1K OHM +5% 1/16W
R345	0100041M	CF 100 OHM +5% 1/18W	R480	0119514S	MG 1.0 OHM +5% 1/4W
R346	0700027M	CF 100 OHM +5% 1/18W	R481	0114141M	CF 270 OHM +5% 1/4W
R349	0700027M	CF 100 OHM +5% 1/18W	R483	0700067M	CF 100K OHM +5% 1/16W
R350	0700027M	CF 100 OHM +5% 1/18W	R484	0700051M	CF 5.6K OHM +5% 1/16W
R354	0700036M	CF 470 OHM +5% 1/16W	R486	0700027M	CF 100 OHM +5% 1/16W
R355	0100038M	CF 75 OHM +5% 1/18W	R487	0700027M	CF 100 OHM +5% 1/16W
R373	0119514S	MG 10 OHM +5% 1/4W	R488	0700051M	CF 5.6K OHM +5% 1/16W
R374	0100121M	CF 220K OHM +5% 1/18W	R492	0100063M	CF 820 OHM +5% 1/16W
R387	0700037M	CF 560 OHM +5% 1/18W	R493	0100063M	CF 820 OHM +5% 1/16W
R388	0700027M	CF 100 OHM +5% 1/18W	R494	0700041M	CF 1K OHM +5% 1/16W
R389	0700027M	CF 100 OHM +5% 1/18W	R495	0700041M	CF 1K OHM +5% 1/16W
R390	0700036M	CF 470 OHM +5% 1/16W	R498	014711B	WVW 1.0 OHM +5% 3W
R391	0700036M	CF 470 OHM +5% 1/16W	R502	0700027M	CF 100 OHM +5% 1/16W
R392	0100053M	CF 330 OHM +5% 1/18W	R504	0100041M	CF 100 OHM +5% 1/18W
R393	0700038M	CF 680 OHM +5% 1/16W	R505	0100041M	CF 100 OHM +5% 1/18W
R394	0700027M	CF 100 OHM +5% 1/18W	R506	0100041M	CF 100 OHM +5% 1/18W
R395	0100057M	CF 470 OHM +5% 1/18W	R507	0700027M	CF 100 OHM +5% 1/16W
R396	0700037M	CF 560 OHM +5% 1/16W	R508	0700045M	CF 2.2K OHM +5% 1/18W
R397	0700027M	CF 100 OHM +5% 1/18W	R509	0700045M	CF 2.2K OHM +5% 1/18W
R3A1	0700046M	CF 2.2K OHM +5% 1/16W	R510	0700045M	CF 2.2K OHM +5% 1/16W
R401	0700027M	CF 100 OHM +5% 1/18W (Not for NICAM/A2 models)	R512	0700041M	CF 1K OHM +5% 1/16W
R403	0700041M	CF 1K OHM +5% 1/18W (Not for NICAM/A2 models)	R514	0700041M	CF 1K OHM +5% 1/16W
R404	0700034M	CF 330 OHM +5% 1/16W (Not for NICAM/A2 models)	R516	0700041M	CF 1K OHM +5% 1/16W
			R517	0700041M	CF 1K OHM +5% 1/16W
			R518	0700041M	CF 1K OHM +5% 1/16W
			R519	0700054M	CF 10K OHM +5% 1/16W

制品安全上的注意: 在下表附带△标记的机件具备特别的安全特性。要替换这些机件以前请详细阅读这检修手册中“制品安全上的注意: 一书, 以避免因检修不当而降低电视机的安全性。

PRODUCT SAFETY NOTE: Components marked with a △ have special characteristics important to safety. Before replacing any of these components, read carefully the PRODUCT SAFETY NOTICE of this Service Manual. Don't degrade the safety of the receiver through improper servicing.

SYMBOL No.	PART No.	DESCRIPTIONS	SYMBOL No.	PART No.	DESCRIPTIONS
R520	0700027M	CF 100 OHM +5% 1/16W	R676	0700041M	CF 1K OHM +5% 1/16W
R521	0700027M	CF 100 OHM +5% 1/16W	R677	0700041M	CF 1K OHM +5% 1/16W
R522	0700027M	CF 100 OHM +5% 1/16W	R6A1	0700045M	CF 2.2K OHM +5% 1/16W
R533	0700027M	CF 100 OHM +5% 1/16W	R6A2	0700041M	CF 1K OHM +5% 1/16W
R534	0700027M	CF 100 OHM +5% 1/16W	R720	0110201S	MF 15 OHM +5% 2W
R535	0700044M	CF 1.8K OHM +5% 1/16W	R721	0110211S	MF 39 OHM +5% 2W
R536	0700027M	CF 100 OHM +5% 1/16W	R722	0100057M	CF 470 OHM +5% 1/16W
		(For Ttext models only)	R723	0100049M	CF 220 OHM +5% 1/18W
R537	0700027M	CF 100 OHM +5% 1/16W	R724	0700041M	CF 1K OHM +5% 1/16W
		(For Ttext models only)	R725	0700054M	CF 10K OHM +5% 1/16W
R554	0700036M	CF 470 OHM +5% 1/16W	R727	0700054M	CF 10K OHM +5% 1/16W
R555	0700054M	CF 10K OHM +5% 1/16W	R730	0700051M	CF 5.6K OHM +5% 1/16W
		(Not for Ttext models)	R731	0700027M	CF 100 OHM +5% 1/16W
R611	0700048M	CF 3.9K OHM +5% 1/16W	R732	0145051S	YW 2.7K OHM +5% 1W
R612	0700051M	CF 5.6K OHM +5% 1/16W	R733	0700027M	CF 100 OHM +5% 1/16W
R613	0700067M	CF 100K OHM +5% 1/16W	R735	0119658M	MF 0.22 OHM +5% 1W
R614	0700066M	CF 82K OHM +5% 1/16W	R736	0700026M	CF 82 OHM +5% 1/16W
R615	0188123M	CF 270 OHM +5% 1/2W	R737	0114145M	CF 390 OHM +5% 1/4W
R617	0108127M	CF 390K OHM +5% 1/18W	R741	0100093M	CF 6.8K OHM +5% 1/2W
R618	0700061M	CF 33K OHM +5% 1/16W	R742	0114207M	CF 18K OHM +5% 1/4W
R621	0119722M	MF 1.0 OHM +5% 1W	R743	AZ00026M	2.5A PROTECTOR
R631	0700058M	CF 22K OHM +5% 1/16W	R744	AZ00026M	2.5A PROTECTOR
R632	0119722M	MF 1.0 OHM +5% 1W	R745	AZ00026M	2.5A PROTECTOR
R633	0700054M	CF 10K OHM +5% 1/16W	R749	0100103M	CF 39K OHM +5% 1/18W
R651	0188135M	CF 2.2K OHM +5% 1/2W	R750	0700059M	CF 27K OHM +5% 1/16W
R653	0700046M	CF 2.7K OHM +5% 1/16W	R751	0700032M	CF 220 OHM +5% 1/16W
R654	0700067M	CF 100K OHM +5% 1/16W	R754	0114163M	CF 1.2K OHM +5% 1/4W
R655	0700045M	CF 2.2K OHM +5% 1/16W	R755	0700039M	CF 820 OHM +5% 1/16W
R656	0150156	1VR 10K OHM(B)	R760	0700063M	CF 47K OHM +5% 1/16W
R657	0150156	1VR 10K OHM(B)	R760A	0100093M	CF 15K OHM +5% 1/18W
R658	0700054M	CF 10K OHM +5% 1/16W	R772	0110243S	MF 820 OHM +5% 2W
R659	0700054M	CF 10K OHM +5% 1/16W	R781	0110279S	MF 3.9K OHM +5% 1W
R690	0700063M	CF 47K OHM +5% 1/16W	R782	0100066M	CF 1K OHM +5% 1/18W
R681	0700049M	CF 4.7K OHM +5% 1/16W	R784	0147817A	YW 2.7 OHM +5% 15W
R682	0700059M	CF 27K OHM +5% 1/16W	R785	0700044M	CF 1.8K OHM +5% 1/16W
R683	0179561M	MG 2.2M OHM +5% 1/8W	R786	0100105M	CF 47K OHM +5% 1/18W
R684	0700054M	CF 10K OHM +5% 1/16W	R787	0700057M	CF 100K OHM +5% 1/16W
R685	0700054M	CF 10K OHM +5% 1/16W	R791	0700049M	CF 4.7K OHM +5% 1/16W
R686	0700041M	CF 1K OHM +5% 1/16W	R794	0100101M	CF 33K OHM +5% 1/18W
R688	0700067M	CF 100K OHM +5% 1/16W	R796	0700072M	CF 220K OHM +5% 1/16W
R689	0700053M	CF 8.2K OHM +5% 1/16W	R797	0700055M	CF 12K OHM +5% 1/16W
R670	0700061M	CF 33K OHM +5% 1/16W	R7A1	0700038M	CF 680 OHM +5% 1/16W
R671	0100119M	CF 180K OHM +5% 1/18W	R7A2	0700031M	CF 180 OHM +5% 1/16W
R672	0700059M	CF 27K OHM +5% 1/16W			
R673	0700063M	CF 47K OHM +5% 1/16W			

SYMBOL No.	PART No.	DESCRIPTIONS	SYMBOL No.	PART No.	DESCRIPTIONS
R7A3	0700054M	CF 10K OHM +5% 1/16W	R883	0113701M	CF 10 OHM +5% 1/2W
R7A4	0100113M	CF 100K OHM +5% 1/18W	R884	0100035M	CF 56 OHM +5% 1/18W
R7A5	0700053M	CF 8.2K OHM +5% 1/16W	R885	0100035M	CF 56 OHM +5% 1/18W
R7A7	0700053M	CF 8.2K OHM +5% 1/16W	R886	0114165M	CF 1.5K OHM +5% 1/4W
R802	0113744M	CF 560 OHM +5% 1/2W	R867	0100059M	CF 1.5K OHM +5% 1/18W
R803	0113744M	CF 560 OHM +5% 1/2W	R868	0188132M	CF 1.2K OHM +5% 1/2W
R804	0113744M	CF 560 OHM +5% 1/2W	R869	0100057M	CF 1.2K OHM +5% 1/18W
R805	AT00383S	MF 8.2K OHM +5% 3W	R870	0188155M	CF 68K OHM +5% 1/2W
R806	AT00383S	MF 8.2K OHM +5% 3W	R871	0114221M	CF 68K OHM +5% 1/4W
R807	AT00383S	MF 8.2K OHM +5% 3W	R872	0113776M	CF 12K OHM +5% 1/2W
R808	0100041M	CF 100 OHM +5% 1/18W	R873	0113716M	CF 43 OHM +5% 1/2W
R809	0100041M	CF 100 OHM +5% 1/18W	R874	0113716M	CF 43 OHM +5% 1/2W
R810	0100041M	CF 100 OHM +5% 1/18W	R875	0113869M	CF 2.7 OHM +5% 1/2W
R814	0100049M	CF 220 OHM +5% 1/18W	R876	0113869M	CF 2.7 OHM +5% 1/2W
R815	0100049M	CF 220 OHM +5% 1/18W	R877	0110229S	MF 220 OHM +5% 2W
R816	0100049M	CF 220 OHM +5% 1/18W	R878	0700041M	CF 1K OHM +5% 1/16W
R817	0100071M	CF 1.8K OHM +5% 1/18W	R880	0700061M	CF 33K OHM +5% 1/16W
R818	0100071M	CF 1.8K OHM +5% 1/18W	R884	0110132S	MF 300 OHM +5% 1W
R819	0100071M	CF 1.8K OHM +5% 1/18W	R886	0700027M	CF 100 OHM +5% 1/16W
R822	0100041M	CF 100 OHM +5% 1/18W	R887	0113752M	CF 1.2K OHM +5% 1/2W
R823	0100041M	CF 100 OHM +5% 1/18W	R889	0700033M	CF 270 OHM +5% 1/16W
R824	0100041M	CF 100 OHM +5% 1/18W	R890	0700029M	CF 150 OHM +5% 1/16W
R825	0113815M	CF 470K OHM +5% 1/2W	R891	0700045M	CF 2.2K OHM +5% 1/18W
R836	0700039M	CF 820 OHM +5% 1/16W	R901	0147610A	WW 1.0 OHM +5% 7W
R837	0700039M	CF 820 OHM +5% 1/16W	R901A	0147610A	WW 1.0 OHM +5% 7W
R838	0700041M	CF 1K OHM +5% 1/16W	R902	0113791M	CF 47K OHM +5% 1/2W
R839	0700035M	CF 390 OHM +5% 1/16W	R903	0113787M	CF 33K OHM +5% 1/2W
R841	0110141S	MF 680 OHM +5% 1W	R904	0100085M	CF 6.8K OHM +5% 1/18W
R842	0700066M	CF 82K OHM +5% 1/16W	R905	0147582A	WW 560 OHM +5% 5W
R843	0700035M	CF 390 OHM +5% 1/16W	R906	0147670A	WW 330 OHM +5% 7W
R844	0700035M	CF 390 OHM +5% 1/16W	R907	0147072BF	WW 100 OHM +5% 2W
R845	0700044M	CF 1.8K OHM +5% 1/16W	R908	0100089M	CF 10K OHM +5% 1/18W
R846	0700059M	CF 27K OHM +5% 1/16W	R909	0700061M	CF 33K OHM +5% 1/16W
R847	0700085M	CF 68K OHM +5% 1/16W	R910	0113733M	CF 220 OHM +5% 1/2W
R848	0700059M	CF 27K OHM +5% 1/16W	R911	0110126S	MF 220 OHM +5% 1W
R849	0100057M	CF 470 OHM +5% 1/18W	R912	0113725M	CF 100 OHM +5% 1/2W
R853	0700067M	CF 100K OHM +5% 1/16W	R913	0700032M	CF 220 OHM +5% 1/16W
R854	0700058M	CF 22K OHM +5% 1/16W	R914	0147126BF	WW 2.2 OHM +5% 3W
R855	0700047M	CF 3.3K OHM +5% 1/16W	R915	0114171M	CF 2.7K OHM +5% 1/4W
R856	0113742M	CF 470 OHM +5% 1/2W	R916	0114163M	CF 1.2K OHM +5% 1/4W
R858	0700039M	CF 470 OHM +5% 1/16W	R917	0100041M	CF 100 OHM +5% 1/18W
R859	0700067M	CF 100K OHM +5% 1/16W	R918	0110129S	WW 150 OHM +5% 1W
R860	0700055M	CF 12K OHM +5% 1/16W	R920	0147652A	WW 150 OHM +5% 7W
R861	0188131M	CF 1K OHM +5% 1/2W	R940	0110217S	MF 68 OHM +5% 2W
R862	0700024M	CF 56 OHM +5% 1/16W	R953	0700043M	CF 1.5K OHM +5% 1/16W

制品安全上的注意: 在下表附带△标记的机件具备特别的安全性。要替换这些机件以前请详细阅读这检修手册中“制品安全上的注意: 一书, 以避免因检修不当而降低电视机的安全性。

PRODUCT SAFETY NOTE: Components marked with a △ have special characteristics important to safety. Before replacing any of these components, read carefully the PRODUCT SAFETY NOTICE of this Service Manual. Don't degrade the safety of the receiver through improper servicing.

SYMBOL No.	PART No.	DESCRIPTIONS	SYMBOL No.	PART No.	DESCRIPTIONS
R957	0113756M	CF 1.8K OHM +5% 1/2W	RK643	AZ00104M	2A PROTECTOR
R958	0700049M	CF 4.7K OHM +5% 1/16W	S001	FE00281	TACT SW
R959	0700049M	CF 4.7K OHM +5% 1/16W	S002	FE00281	TACT SW
R960	0700049M	CF 4.7K OHM +5% 1/16W	△ S601	2634731	MAIN SWITCH
R961	0700049M	CF 4.7K OHM +5% 1/16W	T701	BS00011	H.DRIVE TRANS
R962	0113791M	CF 4.7K OHM +5% 1/16W	△ T702	BW01162	FBT
R964	0100075M	CF 2.7K OHM +5% 1/16W	△ T901	BT00952	SWITCHING TRANSFORMER
R965	0700048M	CF 3.9K OHM +5% 1/16W	TF01	BT01371	DF TRANSFORMER
R966	0113791M	CF 4.7K OHM +5% 1/2W	TH61	2340371	THERMISTOR
R967	0110255S	MF 2.7K OHM +5% 2W	TH901	CJ00131	PTC THERMISTOR
R968	0110239S	MF 560 OHM +5% 2W	U001	HJ00133	TUNER BTP-AH452
R969	0700054M	CF 10K OHM +5% 1/16W	U404	HP00452	A2 UNIT - 751 only
R970	0700049M	CF 4.7K OHM +5% 1/16W	U404	HP00453	NICAM UNIT - 081S/051/682 only
R971	0113742M	CF 4.7K OHM +5% 1/2W	VR951	AW00101	VR 500 OHM(B)
△ R998	0174704	MF 10M OHM +5% 1W	WPDE	EF09011	1J MINI CONN. WWIRE
RA10A	0700049M	CF 3.9K OHM +5% 1/16W	WPH1	EF09021	3J MINI CONN. WWIRE
RA11	0100117M	CF 150K OHM +5% 1/18W	X001	CZ00522	R/C RECEIVER
RA12	0700039M	CF 820 OHM +5% 1/16W	X002	2168371	XTAL 6MHZ
RA13	0700049M	CF 4.7K OHM +5% 1/16W	X003	2791754R	LC FILTER
RA14	0100133M	CF 680K OHM +5% 1/18W	X004	2791754R	LC FILTER
RA19	0700054M	CF 10K OHM +5% 1/16W	X201	BG00571	SAW FILTER K9262K
RA56	0700047M	CF 3.3K OHM +5% 1/16W	X204	2167371	CER TRAP. 5.5/5.74MHZ
RA57	0700047M	CF 3.3K OHM +5% 1/16W	X205	2143472	CER TRAP 6.0/6.5MHZ
RA58	0700053M	CF 8.2K OHM +5% 1/16W	X206	2142241	CER TRAP 4.5MHZ
RA59	0700053M	CF 8.2K OHM +5% 1/16W	X208	BJ00271	FILTER SAF33.4M
RDA01	0700051M	CF 5.6K OHM +5% 1/16W	X2A1	BN00081	CER FILTER 31.9M
RE01	0700042M	CF 1.2K OHM +5% 1/16W (Not for NICAM/A2 models)	X2A1	BN00081	CER FILTER 31.9M
RE02	0700044M	CF 1.8K OHM +5% 1/16W (Not for NICAM/A2 models)	X301	2150411	DELAY LINE(200Nsec)
RE37	0700027M	CF 100 OHM +5% 1/16W (For NICAM/A2 models only)	X302	2143893	TRAP COIL 4.43MHZ
RE38	0700027M	CF 100 OHM +5% 1/16W (For NICAM/A2 models only)	X401	2167311	CER. FILTER 4.5MHZ (Not for NICAM/A2 models)
RE39	0700027M	CF 100 OHM +5% 1/16W (For NICAM/A2 models only)	X402	2167211A	CER. FILTER 5.5MHZ (Not for NICAM/A2 models)
RE40	0700027M	CF 100 OHM +5% 1/16W (Not for NICAM/A2 models)	X403	2167212A	CER. FILTER 6.0MHZ (Not for NICAM/A2 models)
RE41	0700027M	CF 100 OHM +5% 1/16W (Not for NICAM/A2 models)	X404	2167213A	CER. FILTER 6.5MHZ (Not for NICAM/A2 models)
RE41	0110203S	MF 18 OHM +5% 2W (For NICAM/A2 models only)	X501	BP00661	XTAL 16.2MHZ
RF01	0110161S	MF 4.7K OHM +5% 1W	ZD721	2339854M	ZD HZS7B1
RK155	0700027M	CF 100 OHM +5% 1/16W	ZD752	2339843M	ZD HZS6A3
RK311	0700027M	CF 100 OHM +5% 1/16W	ZD753	2339867	ZD HZS9C1
RK312	0700027M	CF 100 OHM +5% 1/16W	ZD901	2339834M	ZD HZS5B1
RK313	0700027M	CF 100 OHM +5% 1/16W	ZD902	2339825M	ZD HZS4B2
			ZD903	2331795M	ZD HZS2B2
			ZD904	2331795M	ZD HZS2B2

SYMBOL No.	PART No.	DESCRIPTIONS	SYMBOL No.	PART No.	DESCRIPTIONS
ZD905	2339842M	ZD HZS6A2			
ZD906	2339867M	ZD HZS9C1			
ZD908	2339921M	ZD HZS20-1			
ZD910	2331795M	ZD HZS6B2			
ZD951	2339854M	ZD HZS7B1			
ZD952	2339222M	ZD HZS27-2L			
ZD953	2339847M	ZD HZS6C1			
ZD954	2339221M	ZD HZS27-1L			
	2778242	CF MAGNET			
	DE01731	CRT A68QCU259X(W/DY)			
	DE01732	CRT A68QCU259X(Without DY)			
	BY01291	DY			
	HL01181	REMOTE CON. TRX CLE-938			
	QD07142	BACK COVER ASSY			
	QD07581	FRAME ASSY(051 only)			
	QD07582	FRAME ASSY(081S/982 only)			
	QD07583	FRAME ASSY (191/192/941/433/041/981/121 only)			
	QD07584	FRAME ASSY(751 only)			

THE FOLLOWING PART LIST FOR TELETEXT PWB ONLY (0815/982 ONLY)

PRODUCT SAFETY NOTE: Components marked with a Δ have special characteristics important to safety. Before replacing any of these components, read carefully the PRODUCT SAFETY NOTICE of this Service Manual. Don't degrade the safety of the receiver through improper servicing.

PRODUCT SAFETY NOTE: Components marked with a Δ have special characteristics important to safety. Before replacing any of these components, read carefully the PRODUCT SAFETY NOTICE of this Service Manual. Don't degrade the safety of the receiver through improper servicing.

ABBREVIATIONS Capacitors..... CD: Ceramic Disk, PF: Polyester Film, EL: Electrolytic, PP: Polypropylene, PK: Paper, TA: Tantalum, TM: Trimmer.
Resistors..... CF: Carbon film, WW: Wire Wound, FR: Fuse Resistor, MG: Metal Glazed, VR: Variable Resistor, CC: Carbon Composition, MF: Metal Oxide Film.
Semiconductors..... TR: Transistor, DI: Diode, ZD: Zener Diode, VA: Varistor, TH: Thermistor.

SYMBOL NO.	PART NO.	DESCRIPTION	SYMBOL NO.	PART NO.	DESCRIPTION
B001	JK00692C	T/TEXT SUB PWB	Q006	CF00875R	TR 2SC5343 Y/G
B5201	JK00072	S2 T/TEXT PWB	Q007	CF00865R	TR 2SA1580 Y/G
C002	0890077R	CD 180PF \pm 10% 50V(B)	Q008	CF00875R	TR 2SC5343 Y/G
C003	0800048R	EL 100MF 10V(SME)	Q5201	CF00875R	TR 2SC5343 Y/G
C006	0800001R	EL 0.47MF 50V(SME)	R001	0700029M	CF 150 OHM \pm 5% 1/16W
C007	0880016R	PF 0.1MF \pm 10% 50V	R002	0700029M	CF 150 OHM \pm 5% 1/16W
C008	0880044R	PF 0.01MF \pm 10% 50V	R003	0700054M	CF 330 OHM \pm 5% 1/16W
C009	0800049R	EL 100MF 16V(SME)	R004	0700049M	CF 4.7K OHM \pm 5% 1/16W
C010	0800047R	EL 100MF 6.3V(SME)	R005	0700047M	CF 3.3K OHM \pm 5% 1/16W
C020	0850087R	CD 0.001MF \pm 10% 50V(B)	R006	0700024M	CF 56 OHM \pm 5% 1/16W
C5200	0258206	CEE PLUG PIN	R007	0700041M	CF 1K OHM \pm 5% 1/16W
C5201	0800048R	EL 100MF 10V(SME)	R008	0700041M	CF 1K OHM \pm 5% 1/16W
C5201	0800143	EL 100MF 6.3V	R009	0700041M	CF 1K OHM \pm 5% 1/16W
C5202	0270734R	PF 0.1MF \pm 5% 50V	R012	0700027M	CF 100 OHM \pm 5% 1/16W
C5203	0880003R	PF 0.001MF \pm 10% 50V	R015	0700027M	CF 100 OHM \pm 5% 1/16W
C5204	0890063R	CD 15PF \pm 5% 50V(SL)	R016	0700027M	CF 100 OHM \pm 5% 1/16W
C5205	0890061R	CD 10PF \pm 5% 50V(SL)	R017	0700027M	CF 100 OHM \pm 5% 1/16W
C5206	0270734R	PF 0.1MF \pm 5% 50V	R018	0700024M	CF 56 OHM \pm 5% 1/16W
C5207	0270734R	PF 0.1MF \pm 5% 50V	R019	0700034M	CF 330 OHM \pm 5% 1/16W
C5208	0270734R	PF 0.1MF \pm 5% 50V	R020	0700032M	CF 220 OHM \pm 5% 1/16W
C5209	0270734R	PF 0.1MF \pm 5% 50V	R021	0700032M	CF 220 OHM \pm 5% 1/16W
C5210	0890118R	CD 22PF \pm 5% 50V(CH)	R022	0700054M	CF 10K OHM \pm 5% 1/16W
C5211	0890118R	CD 22PF \pm 5% 50V(CID)	R023	0700054M	CF 10K OHM \pm 5% 1/16W
C5222	0270734R	PF 0.1MF \pm 5% 50V	R030	0700032M	CF 220 OHM \pm 5% 1/16W
C5299	0270741R	PF 0.33MF \pm 5% 50V	R031	0700043M	CF 1.5K OHM \pm 5% 1/16W
D019	2538321M	DI 18S270	R032	0700029M	CF 150 OHM \pm 5% 1/16W
E901	2902269	10P MINI PLUG PIN WITH BASE	R033	0700027M	CF 100 OHM \pm 5% 1/16W
E1TXT	2972916A	10/ EH CONNECTOR (L=390)	R035	0110207S	MF 27 OHM \pm 5% 2W
IC0001	2004691	IC MM1118XS	R037	0700054M	CF 10K OHM \pm 5% 1/16W
IC5201	2009902	IC SAAS2812P/R	R638	0700041M	CF 1K OHM \pm 5% 1/16W
IC5202	CP00241	IC T900580	R050	0150262	VR 2K OHM-B
IC5203	2007951	IC M-BR24C02	R5204	0700027M	CF 100 OHM \pm 5% 1/16W
L5201	2123781R	PEAKING COIL 100MH	R5205	0700027M	CF 100 OHM \pm 5% 1/16W
L5202	2123098M	LA AXIAL COIL 47MH	R5206	0700027M	CF 100 OHM \pm 5% 1/16W
L5203	2122956M	LA AXIAL COIL 100MH	R5207	0700033M	CF 270 OHM \pm 5% 1/16W
Q001	CF00865R	TR 2SA1580 Y/G	R5209	0700027M	CF 100 OHM \pm 5% 1/16W
Q002	CF00875R	TR 2SC5343 Y/G	R5210	0700047M	CF 3.3K OHM \pm 5% 1/16W
Q003	2326875R	TR DTC144WS	R5211	0700059M	CF 27K OHM \pm 5% 1/16W
Q004	CF00875R	TR 2SC5343 Y/G	R5212	0700034M	CF 330 OHM \pm 5% 1/16W
Q005	CF00875R	TR 2SC5343 Y/G	R5213	0700036M	CF 470 OHM \pm 5% 1/16W

SYMBOL NO.	PART NO.	DESCRIPTION	SYMBOL NO.	PART NO.	DESCRIPTION
R5214	0700036M	CF 470 OHM \pm 5% 1/16W			
R5215	0700036M	CF 470 OHM \pm 5% 1/16W			
R5216	0700036M	CF 470 OHM \pm 5% 1/16W			
R5222	0700027M	CF 100 OHM \pm 5% 1/16W			
R5223	0700027M	CF 100 OHM \pm 5% 1/16W			
R5224	0700041M	CF 1K OHM \pm 5% 1/16W			
R5225	0700041M	CF 1K OHM \pm 5% 1/16W			
R5226	0700081M	CF 1M OHM \pm 5% 1/16W			
R5231	0700046M	CF 2.7K OHM \pm 5% 1/16W			
R5232	0700049M	CF 4.7K OHM \pm 5% 1/16W			
R5233	0700049M	CF 4.7K OHM \pm 5% 1/16W			
R5251	0700036M	CF 470 OHM \pm 5% 1/16W			
R5252	0700042M	CF 1.2K OHM \pm 5% 1/16W			
R5253	0700034	CF 10K OHM \pm 5% 1/16W			
R5254	0700062	CF 39K OHM \pm 5% 1/16W			
R5255	0700054	CF 10K OHM \pm 5% 1/16W			
XS201	BP00031	CRYSTAL 27X1527MHZ			
XS202	2940241	CRYSTAL 6 MHZ			
ZD001	2339837M	ZD 1H/SSC1			

HITACHI

C29-F100
[041, 051, 751, 081S, 98*,
,121, 19*, 941, 433]

YS No. 0081C-E

Hitachi Consumer Products (S)

Printed in Singapore