

# GaAlAs HIGH POWER T-1 3/4 PACKAGE INFRARED EMITTING DIODE

## MIE-524H4

### Description

The MIE-524H4 is a GaAlAs infrared LED having a peak wavelength at 850 nm . It feature ultra-high power, high response speed and molded in water clear plastic package, the MIE-524H4 have greatly improved long-distance characteristics as well as as significantly increased its range of applicability.

### Features

- Ultra-High radiant incidence
- Ultra-high speed response
- High modulation bandwidth
- Standard T-1 3/4 (  $\phi$  5mm ) package
- Radiation angle :  $20^\circ$
- Peak wavelength  $\lambda_p = 850$  nm

### Applications

- Free air transmission systems with high -speed response
- SIR

### Absolute Maximum Ratings

' @  $T_A = 25^\circ\text{C}$

Parameter	Maximum Rating	Unit
Power Dissipation	120	mW
Peak Forward Current(300pps,10 $\mu$ s pulse)	1	A
Continuos Forward Current	100	mA
Reverse Voltage	5	V
Operating Temperature Range	-55 $^\circ\text{C}$ to +100 $^\circ\text{C}$	
Storage Temperature Range	-55 $^\circ\text{C}$ to +100 $^\circ\text{C}$	
Lead Soldering Temperature	260 $^\circ\text{C}$ for 5 seconds	

### Package Dimensions

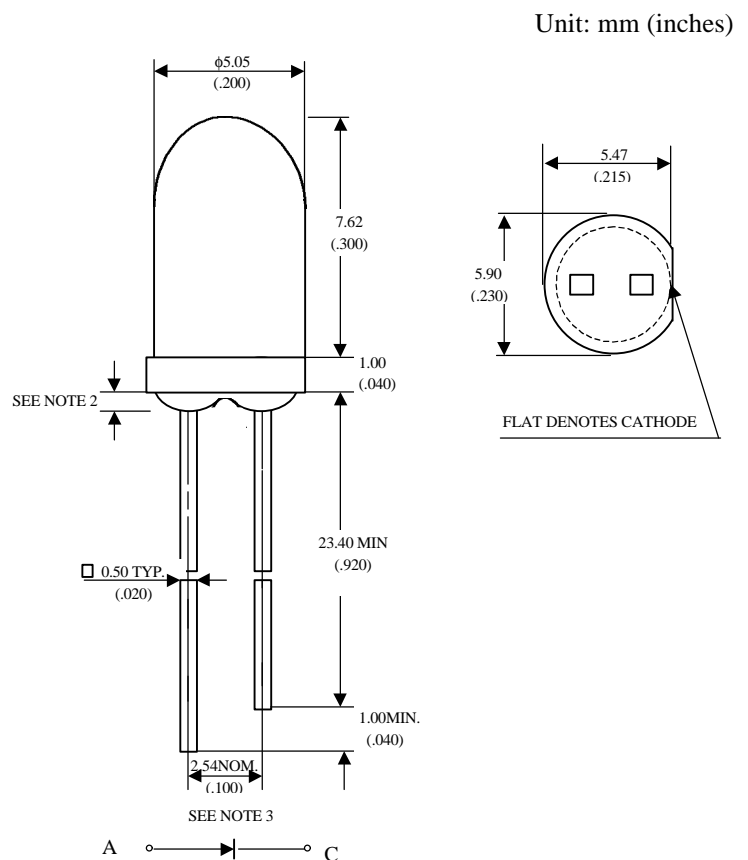

#### NOTES :

1. Tolerance is  $\pm 0.25$  mm (.010") unless otherwise noted.
2. Protruded resin under flange is 1.5 mm (.059") max.
3. Lead spacing is measured where the leads emerge from the package.

**UNI**

Unity Opto Technology Co., Ltd.

11/17/2000

Optical-Electrical Characteristics

@ T<sub>A</sub>=25°C

Parameter	Test Conditions	Symbol	Min.	Typ.	Max.	Unit
Radiant Intensity	I <sub>F</sub> =20mA	I <sub>e</sub>		6.5		mW/sr
Forward Voltage	I <sub>F</sub> =50mA	V <sub>F</sub>		1.5	1.8	V
Reverse Current	V <sub>R</sub> =5V	I <sub>R</sub>			10	μA
Peak Wavelength	I <sub>F</sub> =20mA	λ <sub>p</sub>		850		nm
Spectral Bandwidth	I <sub>F</sub> =20mA	Δλ		30		nm
Half View Angle	I <sub>F</sub> =20mA	2θ <sub>1/2</sub>		20		deg.
Rise Time	I <sub>F</sub> =50mA	T <sub>r</sub>		20		nsec
Fall Time	I <sub>F</sub> =50mA	T <sub>f</sub>		30		nsec

Typical Optical-Electrical Characteristic Curves

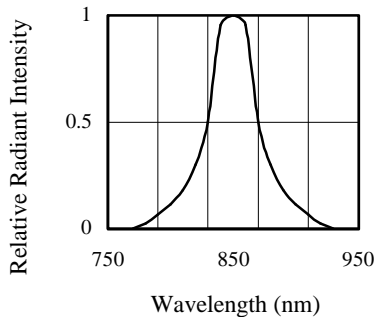

FIG.1 SPECTRAL DISTRIBUTION

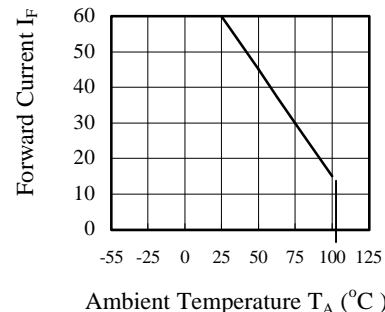

FIG.2 FORWARD CURRENT VS. AMBIENT TEMPERATURE

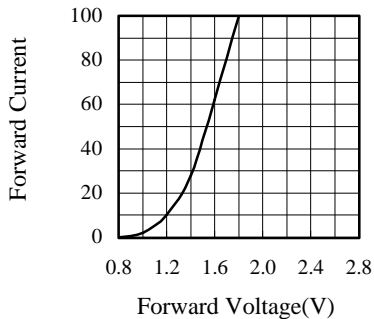

FIG.3 FORWARD CURRENT VS. FORWARD VOLTAGE

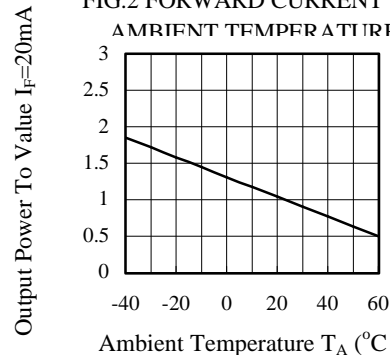

FIG.4 RELATIVE RADIANT INTENSITY VS. AMBIENT TEMPERATURE

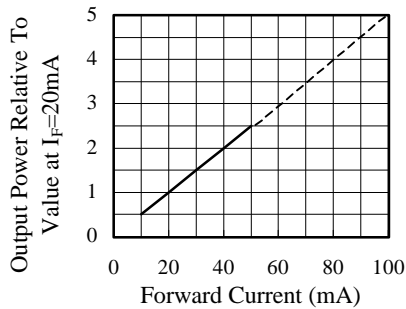

FIG.5 RELATIVE RADIANT INTENSITY VS. FORWARD CURRENT

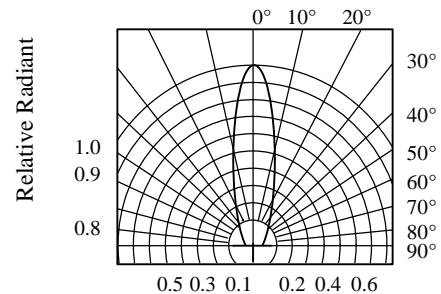

FIG.6 RADIATION DIAGRAM