

Lightning protection for LNB supply and control voltage regulator

Introduction

Communication satellites operate within two frequency bands for TV/Broadband service broadcast signals, C Band and Ku Band. The C Band overall frequency spectrum is 4.0 GHz - 8.0 GHz, while the Ku Band overall frequency spectrum is 10.7 GHz - 18.4 GHz.

Within these bands each satellite has a specific uplink and downlink frequency allocation.

For example:

- Ku Band downlink frequency is 10.7 GHz-12.75 GHz and uplink frequency is 17.3 GHz-17.8 GHz.
- C Band downlink frequency is 3.7 GHz-4.2 GHz and uplink frequency is 5.925 GHz-6.425 GHz

To use the frequencies that are available for satellite broadcast as efficiently as possible, and to accommodate an additional number of channels within a given frequency band, the transmission signal can be formatted to be either vertical and horizontal, or circular right-hand and circular left-hand simultaneously per frequency.

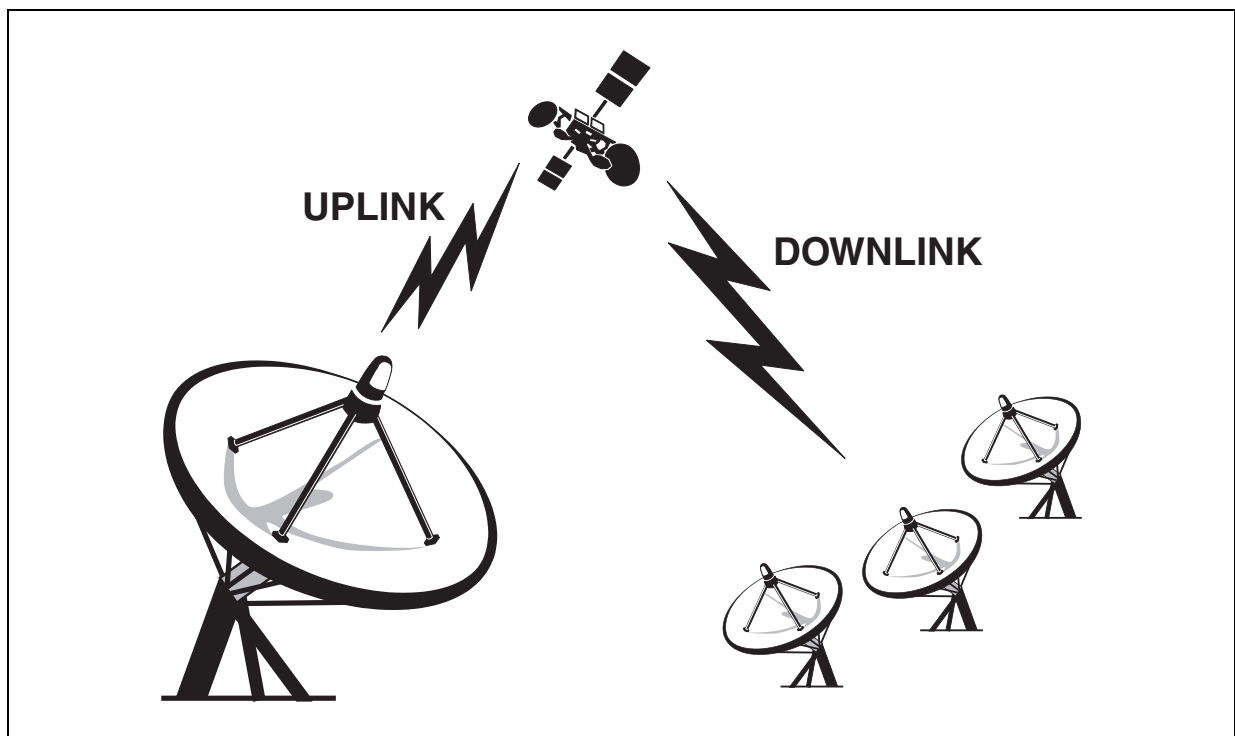

1 What is a Low Noise Block (LNB)?

An LNB is a low noise block module, placed on the focus of the satellite dish antenna (parabola) that provides the following functions:

- Down conversion of the incoming signal from GHz range to the 910 MHz - 2150 MHz (for Europe) range called “first conversion signal”. This conversion allows the signal to be carried by an inexpensive coaxial cable towards the receiver.
- Signal amplification with good noise figure. The LNB improves the first conversion signal level through the use of a built-in low noise amplifier.
- Selection of Vertical or Horizontal polarization.
- Selects operating band by switching its internal oscillator from Low band to High band when the LNB “receives” a 22kHz tone. Specifically, the local oscillator (LO) frequency changes from 9.75 GHz to 10.6 GHz.
 - C Band - LO frequency 9.75 GHz
 - Ku Band - LO frequency 10.6 GHz
- Miscellaneous functions based on 22kHz tone PPM encoding, as discussed later in this paper.

Figure 1. OMNI-LNB architecture

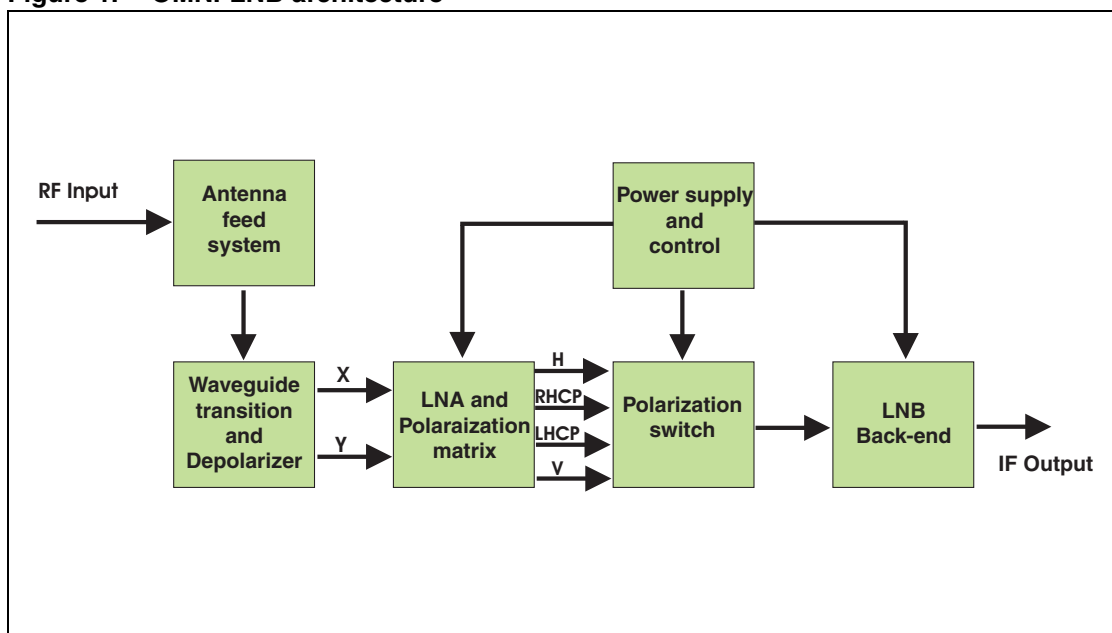

2 Polarization selection

Polarization is a way to give a specific direction to a transmission signal. It increases the beam concentration.

The signal transmitted by satellite can be polarized in one of four different ways: Linear (horizontal or vertical) or Circular (right-hand or left-hand).

Consequently, the satellite can broadcast both H and V or LH and RH polarized signals on one frequency.

Figure 2. The four different ways of polarization

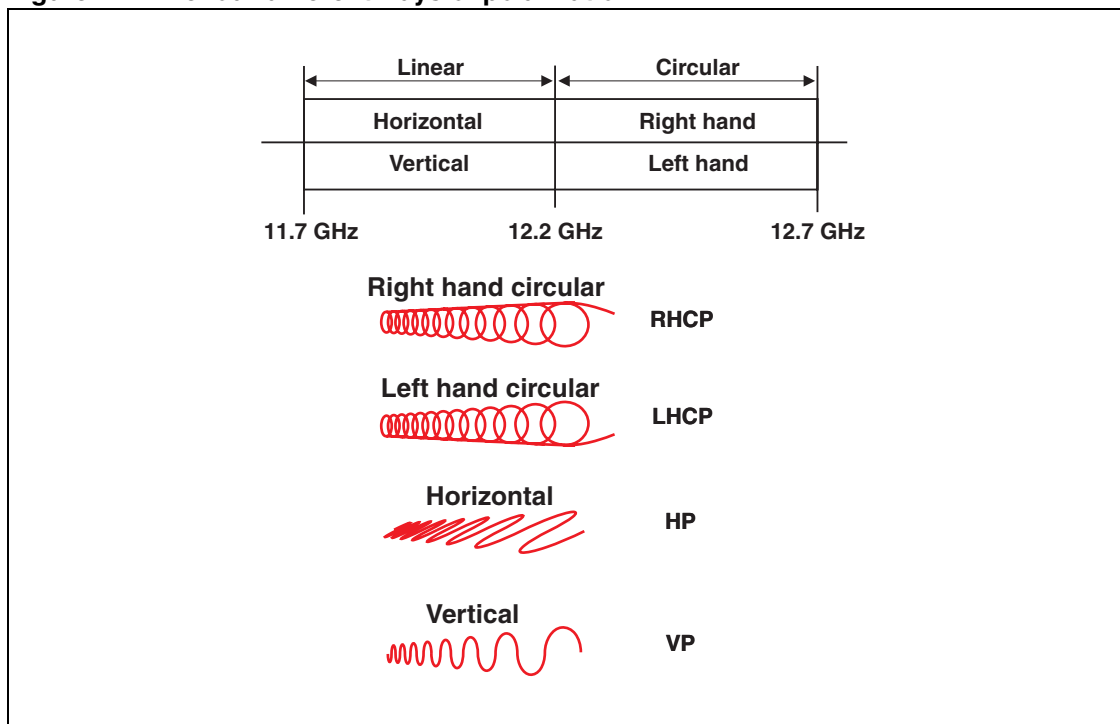

The “universal” LNB switches the polarization by looking at the voltage that it receives from the receiver.

Generally, only two signals 13 V and 18 V are used with one type of antenna.

13 V⁽¹⁾ - Vertical Polarization or Circular Right-Hand Polarization (RHCP)

18 V⁽²⁾ - Horizontal Polarization or Circular Left-Hand Polarization (LHCP)

Also, 1 V can be added from a receiver to any of above voltages to compensate for the voltage drop in the coaxial cable.

1. actually from 11.5 to 14V

2. actually from 15.5 to 21V

3 22kHz Tone and DiSEqC (Digital Satellite Equipment Control) Encoding

In addition to selecting the polarization, the LNB needs to select the operating band. Indeed, each reception band is divided in two bands:

- Low Band (10.7-11.7 GHz)
- High Band (11.7-12.75 GHz).

This is done with the use of a 22kHz tone frequency. A 22 kHz pulse-position modulated signal of about 0.6 V amplitude is superimposed on the LNB's DC power rail. Its coding scheme also allows the remote electronics to perform more complex functions. Traditionally, when other encoding functions do not require the 22 kHz tone, simple presence or absence of this tone selects the operating band by changing the local oscillator frequency of the LNB.

The complex encoding of the 22 kHz burst is done with a more sophisticated communication bus protocol named the DiSEqC standard (Digital Satellite Equipment Control). The open DiSEqC standard developed by the European Telecommunication Satellite Organization is a well accepted worldwide standard for communication between satellite receivers and satellite peripheral equipment.

The 22 kHz oscillator has to be a tone generator with specific rise and fall time. The wave shape will be a quasi-square wave (sine with flat-top). The required frequency tolerance is ± 2 kHz over line and temperature variations.

Table 1. Band and polarization selection table

Parameters		22 kHz Tone present	22 kHz Tone absent
Operating band		High	Low
V _{DC}	13 V	Vertical polarization	Vertical polarization
	18 V	Horizontal polarization	Horizontal polarization

3.1 22 kHz Wave shape and details

Carrier frequency	22 kHz \pm 2 kHz over line and temperature
Carrier amplitude	650 mVpp \pm 250 mV
Modulation mark period	500 μ s \pm 100 μ s
Modulation space period	1 ms \pm 200 μ s

3.2 Modulation method

Figure 3. Modulation scheme

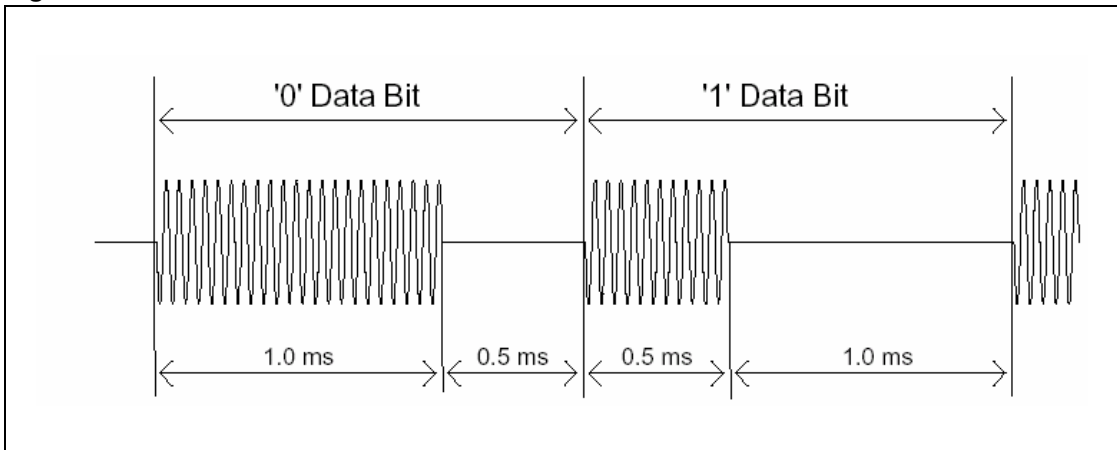
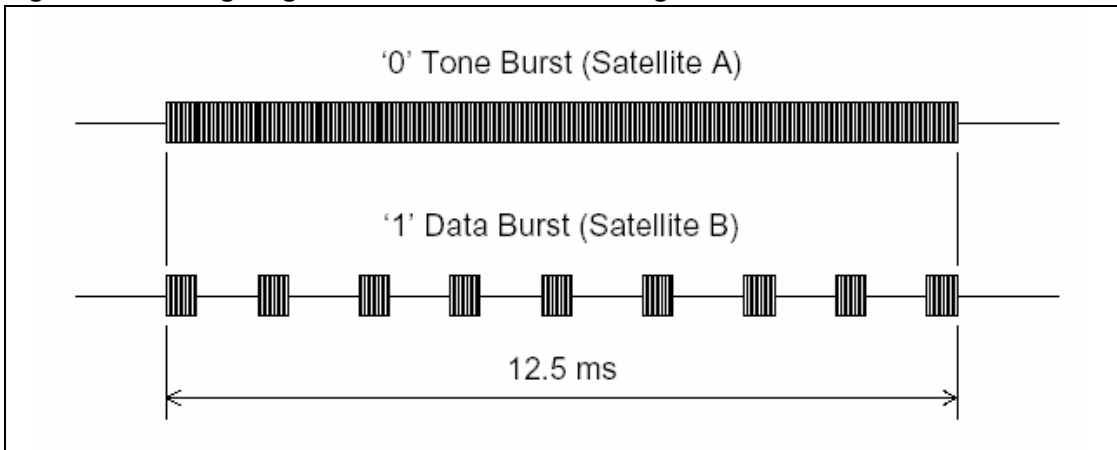

Figure 4. Timing diagram for tone burst control signal



4 The Need for Lightning Protection

The LNB is remotely powered from the satellite receiver. The same coaxial cable that carries the IF signal from the LNB to the receiver carries power from the receiver to the LNB. The 13V to 18V DC is generated by a dedicated IC, a LNB Voltage Regulator.

This device can be damaged by any lightning strike on the coaxial cable or the antenna that can generate high current - high voltage surge at the voltage regulator.

This surge can be simulated according to the IEC61000-4-5 standard:

- $t_r/t_f = 8/20 \mu s$
- $V_{pp} = 3 kV$ to $6 kV$
- $R = 12 \Omega$
- $I_{pp} = 250 A$ to $500 A$

Figure 5. IEC61000-4-5 current waveform

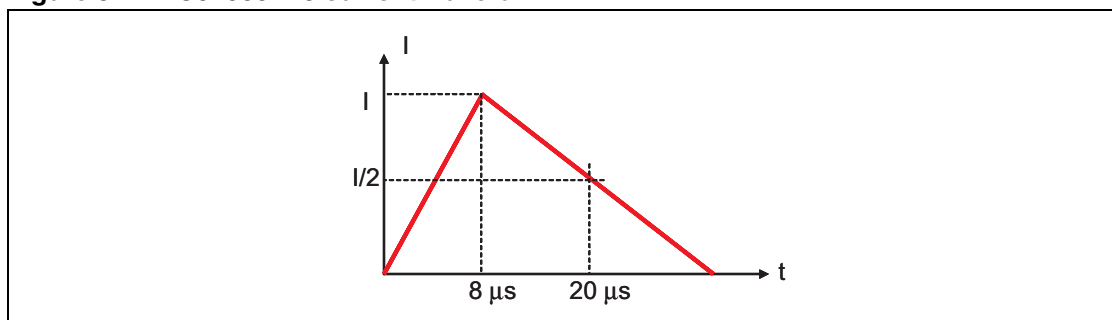

In case of lightning events, the current surge at the LNB voltage regulator (IC) inputs ranges from 250 A (when 3 kV is applied) to 500 A (when 6 kV is applied). This IC can not withstand such high value energy.

To comply with this IEC regulation and to protect the LNB Voltage Regulator IC against any damage from lightning events, a dedicated and optimized protection device is required in front of the voltage regulator.

5 STMicroelectronics solution

To offer Satellite Set Top Box manufacturers the best trade-off between cost and lightning protection of the LNB voltage regulator, STMicroelectronics has introduced the new dedicated and optimized LNBTVSx-22x devices.

5.1 A segmented & differentiated approach

The product strategy is based on a segmented approach to provide the best suitable protection device relative to the various LNB voltage regulator absolute maximum ratings capabilities.

It means that depending on the LNB voltage regulator used in the application and depending on the lightning surge test level applied, a different LNBTVSx-22x has to be implemented to optimize the cost and robustness of the total solution.

As an example:

When the LNBP21 voltage regulator is used and if the box needs to comply with the level 4 of the IEC61000-4-5 (4 kV), the best suitable protection device to be implemented is the LNBTVS4-222S.

See [Table 3](#) for recommended fit.

5.2 Features

- 3 kV, 4 kV and 6 kV protection (8/20 μ s)
- Axial & SMD package
- Low Vf
- Low Clamping factor
- Fast Response Time
- UL Recognized

Figure 6. Surge tests +4 kV (Standard IEC61000-4-5 - with series resistor of 12 Ω)

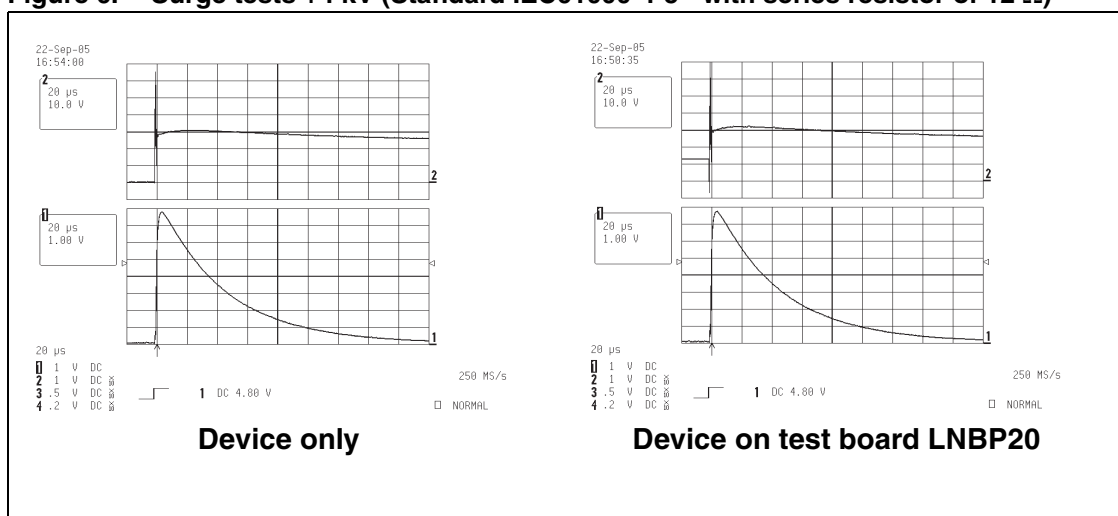

Table 2. LNBTVSx-22xx range

Type	I _{RM} @ V _{RM}		V _{BR} @ I _R				P _{PP} 10/1000 μS	V _{CL} @ I _{pp} 10/1000 μs		V _{CL} @ I _{pp} 8/20 μs ⁽¹⁾		αT	C
	Max		Min	Typ	Max			Max		Max		Max	Typ
Unidirectional	μA	V	V	V	V	mA	W	V	A	V	A	10 ⁻⁴ /°C	pF
LNBTVS3-220	1	20	22	23.1	24.2	1	1500	33.2	45	35	250	9.6	3000
LNBTVS3-220U	1	20	22	23.1	24.2	1	1500	33.2	45	35	250	9.6	3000
LNBTVS4-220	1	20	22	23.1	24.2	1	1800	33.2	55	32	331	9.6	3500
LNBTVS4-220S	1	20	22	23.1	24.2	1	1800	33.2	55	32	331	9.6	3500
LNBTVS4-221	1	20	22	23.1	24.2	1	2000	33.2	60	32	331	9.6	5500
LNBTVS4-221S	1	20	22	23.1	24.2	1	2000	33.2	60	32	331	9.6	5500
LNBTVS4-222S	1	20	22	23.1	24.2	1	3000	33.2	90	30	331	9.6	6000
LNBTVS6-220S	1	20	22	23.1	24.2	1	2000	33.2	60	35	500	9.6	5500
LNBTVS6-221S	1	20	22	23.1	24.2	1	3000	33.2	90	32	500	9.6	6000

1. IEC61000-4-5 R = 12 Ω

Note: In some tests, some customers apply an external power supply voltage in the range of +28 V DC to the coaxial cable. In this case, it is recommended to use a TVS with VRM > 28 V (SM15T33A or SM15T36A).

5.3 Ordering information scheme

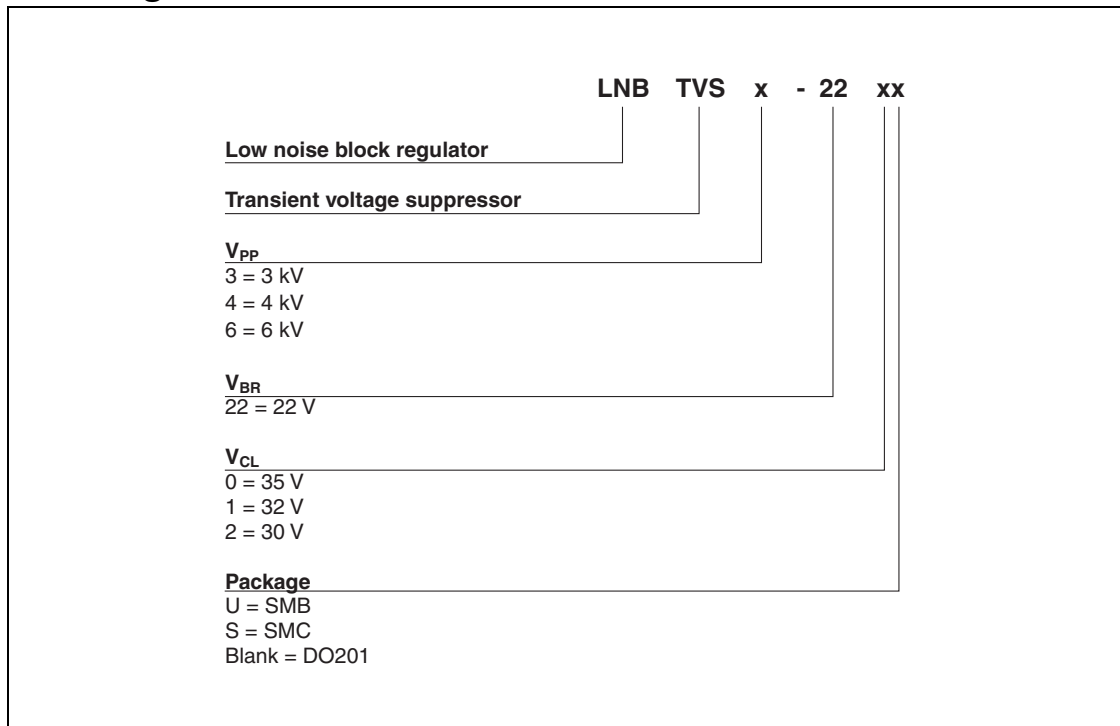

5.4 Application diagram

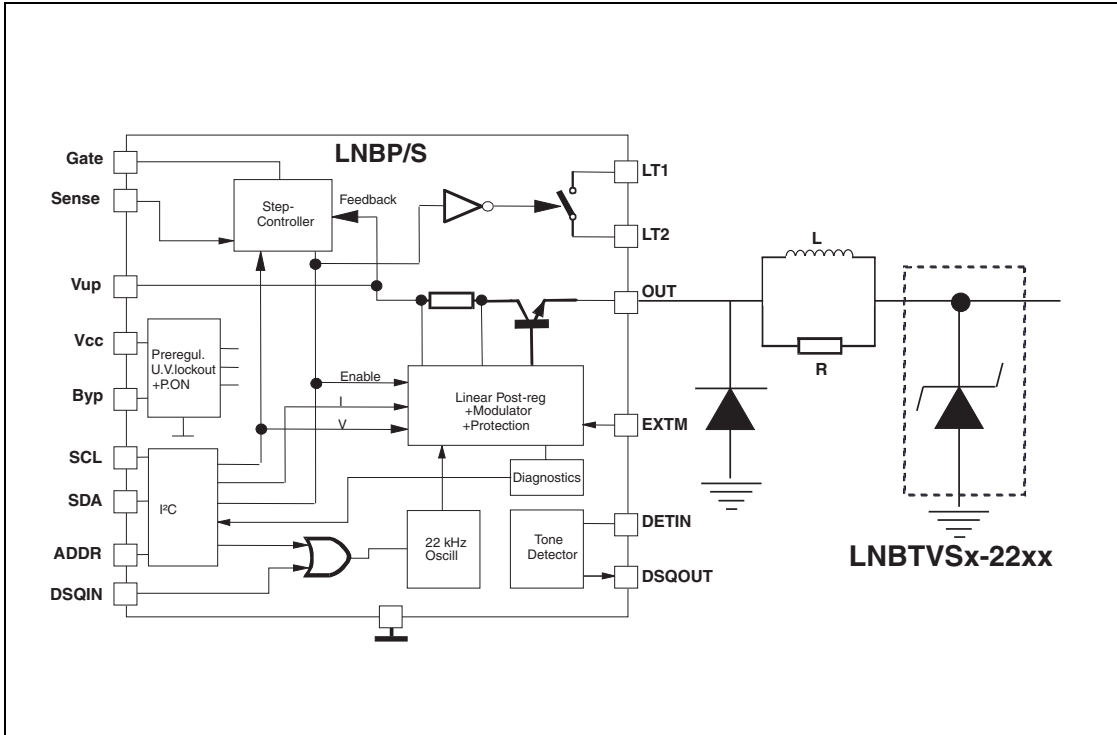

Table 3. Recommended fit between LNB Voltage Regulator and LNBTVSx-22xx lightning protections

LNB voltage regulators	Recommended lightning protection
LNBP20, LNBP11x, LNBP8/9	LNBTVS3-220/x, LNBTVS4-220/x, LNBTVS6-220S
LNBS21, LNBP21	LNBTVS4-222S
LNBH21, LNBH221, LNBH22, LNBEH21, LNBEH221	LNBTVS4-220/x, LNBTVS4-221/x, LNBTVS6-221S
LNBH23, LNBH24	LNBTVS3-220/x, LNBTVS4-220/x, LNBTVS6-220S

5.5 Benefits

- Simple and Low Cost Solution
- Replace current solutions at lower cost and better performances
- High Reliability Protection Solution
- Dedicated and Optimized for LNB Voltage Regulator protection
- Complies with LNB supply voltages
- Complies with IEC61000-4-5 standard
- Available in Axial and SMD package
- Compatible with all LNB Voltage Regulator types and references

Criteria	Benefits	LNBTVSx-22xx	Competition
Lightning Protection	Up to 6 kV - 500 A	++	+
Reliability, longevity	No diode paralleling	++	-
Coverage vs LNB Reg.	Various P/N	++	-
Cost	Low	++	+
Design and safety	Dedicated for LNB Reg. protection	++	+

6 Conclusion

As explained and demonstrated, all LNB power supplies have to be protected against lightning. The best in class solution for cost effective and reliable protection are the new LNVTVSx-22xx devices from STMicroelectronics. All devices are available and are in mass production.

7 Revision history

Date	Revision	Changes
09-Jan-2006	1	Initial release.

Information furnished is believed to be accurate and reliable. However, STMicroelectronics assumes no responsibility for the consequences of use of such information nor for any infringement of patents or other rights of third parties which may result from its use. No license is granted by implication or otherwise under any patent or patent rights of STMicroelectronics. Specifications mentioned in this publication are subject to change without notice. This publication supersedes and replaces all information previously supplied. STMicroelectronics products are not authorized for use as critical components in life support devices or systems without express written approval of STMicroelectronics.

The ST logo is a registered trademark of STMicroelectronics.
All other names are the property of their respective owners

© 2006 STMicroelectronics - All rights reserved

STMicroelectronics group of companies

Australia - Belgium - Brazil - Canada - China - Czech Republic - Finland - France - Germany - Hong Kong - India - Israel - Italy - Japan -
Malaysia - Malta - Morocco - Singapore - Spain - Sweden - Switzerland - United Kingdom - United States of America

www.st.com