

AZ742

8 A DPDT MINIATURE POWER RELAY

FEATURES

- Dielectric strength 5000 Vrms
- Low height: 15.7 mm
- Epoxy sealed version available
- 8 Amp switching — double pole contacts
- AC and DC coils
- Isolation spacing greater than 10 mm
- Proof tracking index (PTI/CTI) 250
- Reinforced insulation, EN 60730-1 (VDE 0631, part 1) EN 60335-1 (VDE 0700, part 1)
- UL, CUR file E43203
- VDE file 40012572

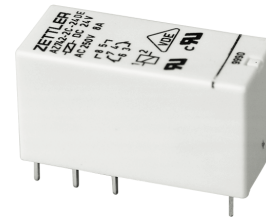

CONTACTS

Arrangement	DPDT (2 Form C) DPST (2 Form A)
Ratings	Resistive load: Max. switched power: 2 X 240 W or 2000 VA Max. switched current: 2 X 8 A Max. switched voltage: 300 VDC* or 400 VAC * Note: If switching voltage is greater than 30 VDC, special precautions must be taken. Please contact the factory.
Rated Load	
UL, CUR	8 A at 250 VAC General Use
VDE	8 A at 250 VAC
Material	Silver nickel, silver nickel gold plated or silver tin oxide
Resistance	< 100 milliohms initially

GENERAL DATA

Life Expectancy Mechanical Electrical	Minimum operations 3 x 10 ⁷ 1 x 10 ⁵ at 8 A 250 VAC res.
Operate Time (typical)	7 ms at nominal coil voltage
Release Time (typical)	3 ms at nominal coil voltage (with no coil suppression)
Dielectric Strength (at sea level for 1 min.)	5000 Vrms coil to contact 2500 Vrms between contact sets 1000 Vrms between open contacts
Insulation Resistance	10 ⁵ megohms min. at 500 VDC, 20°C, 50% RH
Insulation (according to DIN VDE 0110, IEC 60664-1)	B250 at 2 Form C, flux proof version C250 at other relay versions Overvoltage category: III Pollution degree: 3 Nominal voltage: 250 VAC
Dropout DC coils AC coils	Greater than 10% of nominal coil voltage Greater than 15% of nominal coil voltage
Ambient Temperature Operating Storage	At nominal coil voltage -40°C (-40°F) to 85°C (185°F) - DC coils -40°C (-40°F) to 70°C (158°F) - AC coils -40°C (-40°F) to 105°C (221°F)
Vibration	Break contacts: 5 g at 20...500 Hz Make contacts: 20 g at 30...500 Hz
Shock	20 g
Enclosure	P.B.T. polyester, UL-94 : V0
Terminals	Tinned copper alloy, P.C.
Max. Solder Temp.	270°C (518°F)
Max. Solder Time	5 seconds
Max. Solvent Temp.	80°C (176°F)
Max. Immersion Time	30 seconds
Weight	14 grams
Packing unit in pcs	20 per carton tube / 1000 per carton box

COIL

Power	
At Pickup Voltage (typical)	200 mW (DC coil) .422 VA (AC coil)
Max. Continuous Dissipation	1.7 W at 20°C (68°F) ambient 1.7 VA at 20°C (68°F) ambient
Temperature Rise	26°C (47°F) at nominal coil voltage
Max. Temperature	155°C (311°F)

NOTES

1. All values at 20°C (68°F).
2. Relay may pull in with less than "Must Operate" value.
3. Specifications subject to change without notice.

ZETTLER electronics GmbH

Junkersstrasse 3, D-82178 Puchheim, Germany

Tel. +49 89 800 97 0
Fax +49 89 800 97 200

office@ZETTLERelectronics.com
www.ZETTLERelectronics.com

AZ742

RELAY ORDERING DATA

COIL SPECIFICATIONS - DC COIL				ORDER NUMBER*	
Nominal Coil VDC	Must Operate VDC	Max. Continuous VDC	Coil Resistance Ohm $\pm 10\%$	2 Form A	2 Form C
3	2.1	7.6	22	AZ742-2A-3D	AZ742-2C-3D
5	3.5	12.7	60	AZ742-2A-5D	AZ742-2C-5D
6	4.2	15.3	90	AZ742-2A-6D	AZ742-2C-6D
9	6.3	22.9	200	AZ742-2A-9D	AZ742-2C-9D
12	8.4	30.6	360	AZ742-2A-12D	AZ742-2C-12D
18	12.6	45.9	710	AZ742-2A-18D	AZ742-2C-18D
24	16.8	61.2	1,440	AZ742-2A-24D	AZ742-2C-24D
36	25.2	92.0	3,140	AZ742-2A-36D	AZ742-2C-36D
48	33.6	122.0	5,700	AZ742-2A-48D	AZ742-2C-48D
60	42.0	153.0	7,500	AZ742-2A-60D	AZ742-2C-60D
110	77.0	280.0	25,200	AZ742-2A-110D	AZ742-2C-110D

COIL SPECIFICATIONS - AC COIL					ORDER NUMBER*	
Nominal Coil VAC	Must Operate VAC	Max. Continuous VAC	Nominal Current mA $\pm 10\%$	Coil Resistance Ohm $\pm 10\%$	2 Form A	2 Form C
12	9.0	18.0	63.0	100	AZ742-2A-12A	AZ742-2C-12A
24	18.0	36.0	31.3	400	AZ742-2A-24A	AZ742-2C-24A
48	36.0	72.0	15.6	1,550	AZ742-2A-48A	AZ742-2C-48A
60	45.0	90.0	12.5	2,600	AZ742-2A-60A	AZ742-2C-60A
110	82.5	165.0	6.8	8,900	AZ742-2A-110A	AZ742-2C-110A
115	86.3	172.5	6.5	9,600	AZ742-2A-115A	AZ742-2C-115A
120	90.0	180.0	6.3	10,200	AZ742-2A-120A	AZ742-2C-120A
220	165.0	330.0	3.4	35,500	AZ742-2A-220A	AZ742-2C-220A
230	172.5	345.0	3.3	38,500	AZ742-2A-230A	AZ742-2C-230A
240	180.0	360.0	3.1	42,500	AZ742-2A-240A	AZ742-2C-240A

* "2A" or "2C" denote silver nickel contacts.
 Add suffix "G" at "2A" or "2C" for gold plated silver nickel contacts.
 Add suffix "E" at "2A" or "2C" for silver tin oxide contacts.
 Add suffix "E" at the end of order number for sealed version.

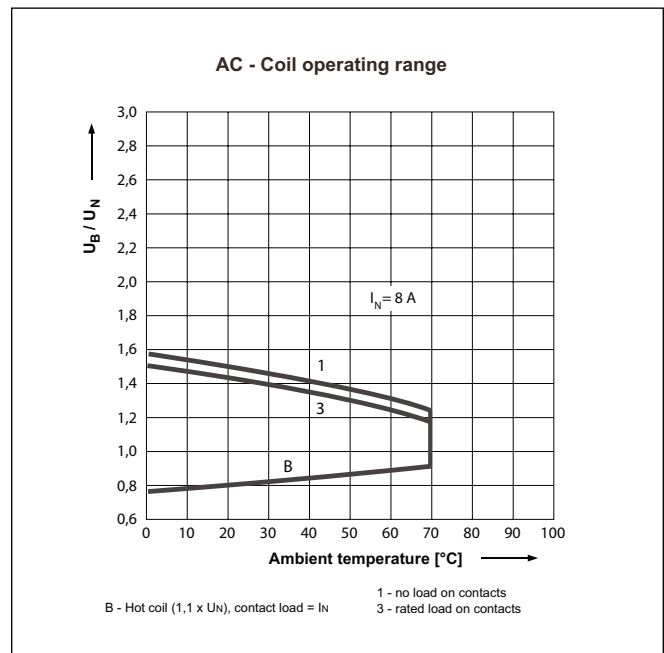
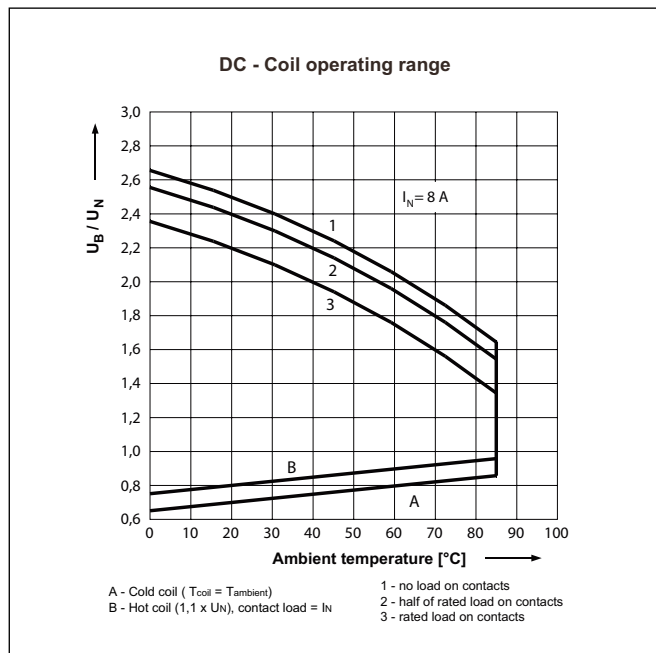

ZETTLER electronics GmbH

Junkersstrasse 3, D-82178 Puchheim, Germany

Tel. +49 89 800 97 0

Fax +49 89 800 97 200

office@ZETTLERelectronics.com

www.ZETTLERelectronics.com

AZ742

MECHANICAL DATA

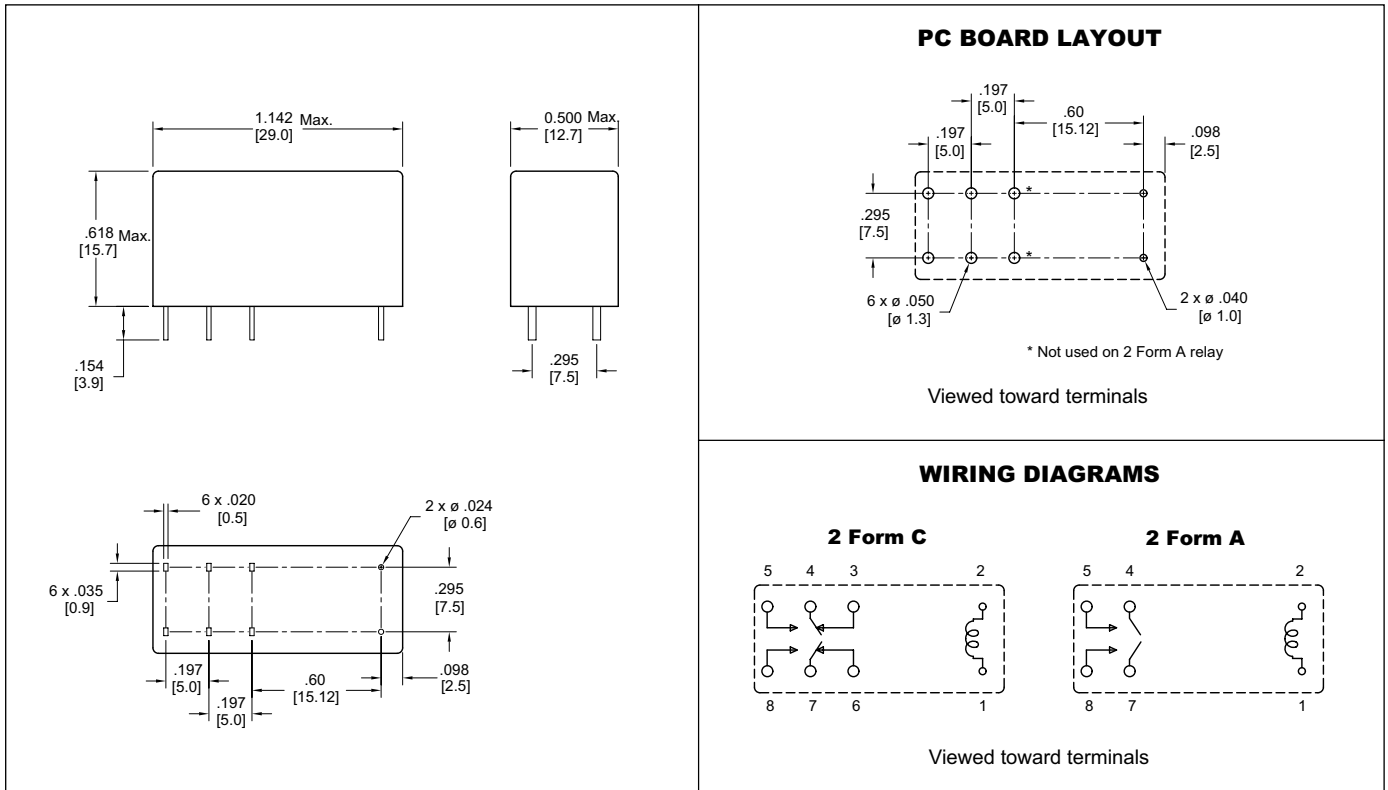

Dimensions in inches with metric equivalents in parentheses. Tolerance: $\pm .010$ "

ACCESSORIES

For P.C.B. mount: Socket EC 50
Retaining Clip MP 16 / MH 16

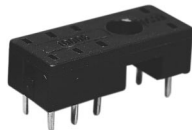

For DIN rail mount: Socket ES 50
Retaining Clip MS 16

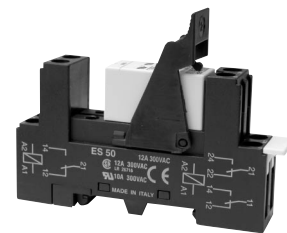

MECHANICAL DATA

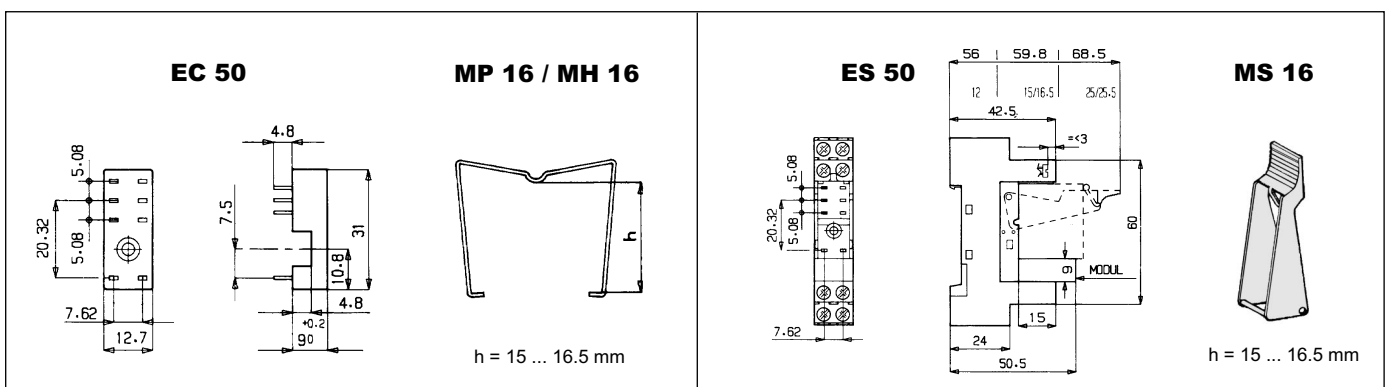

ZETTLER electronics GmbH

Junkersstrasse 3, D-82178 Puchheim, Germany

Tel. +49 89 800 97 0
Fax +49 89 800 97 200

office@ZETTLERelectronics.com
www.ZETTLERelectronics.com

Electrical life at 250 VAC, resistive load

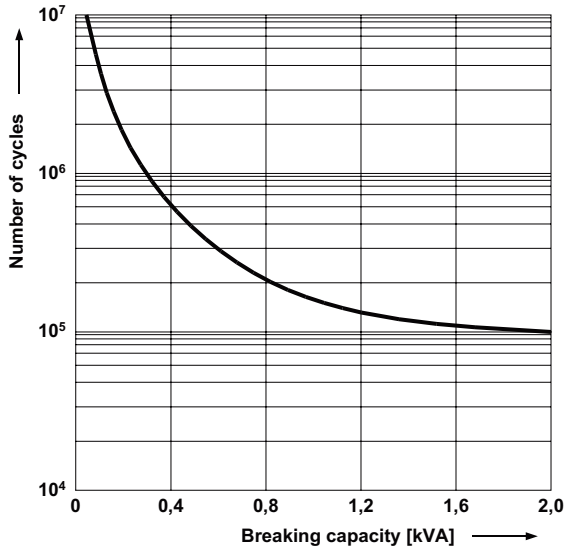

Electrical life reduction factor at inductive AC load

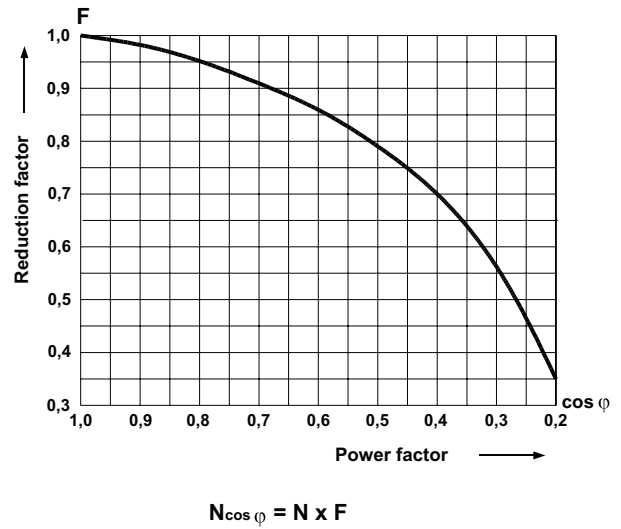

Max. DC resistive load breaking capacity

