



# Snap/Clip-Lock Environmentally Sealed - Circular

## Engineering Quick Reference Selection Guide

	2 Position		4 Position	5 Position	
<b>Contact Arrangement</b>	<b>Plug</b> 	<b>Receptacle</b> 	Contact Cannon	<b>Plug</b> 	<b>Receptacle</b> 
<b>Features</b>	Inline	Feed Thru	Inline	PCB	Inline
	Clip Lock	Clip Lock	Clip Lock	Snap Lock	Snap Lock
<b>Specifications</b>	CS-216	CS-216	CS-216	CS-206	CS-206
<b>Plug</b>	086-0066-000 w/Wedgelock 086-0058-000 Standard	086-0058-000 Standard	Contact Cannon	098532-0000 (5 A) 098532-001 (13 A)	098532-0000 (5 A) 098532-001 (13 A)
<b>Receptacle</b>	086-0061-000 w/Wedgelock	083-0242-000	Contact Cannon	098531-0000 (5 A) 098531-0001 (13 A)	098530-0000 (5 A) 098530-0001 (13 A)
<b>Terminals</b>	See page 14	See page 14	Contact Cannon	See page 14	See page 14

## How to Order

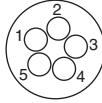
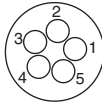
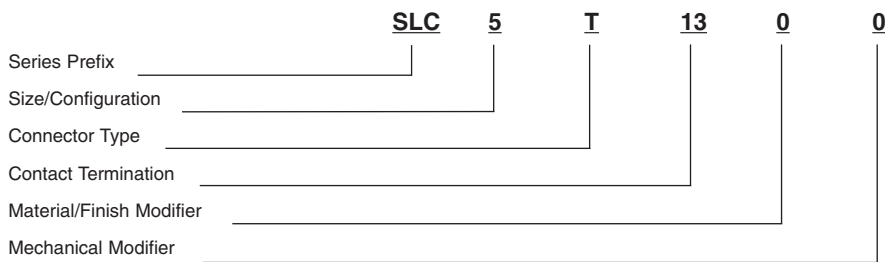

**Series Prefix**  
SLC - Snap-Lock Circular

**Size/Configuration**  
5-5 Cavity Housing  
8-8 Cavity Housing  
10-10 Cavity Housing  
15-15 Cavity Housing

**Connector Type**  
P - Plug, In-line (Cable-to-Cable)\*  
R - Receptacle, In-line (Cable-to-Cable)  
T - Receptacle, Snap-thru  
B - Receptacle, PCB

**Contact Termination**  
5 - 5 A  
13 - 13 A

**Material/Finish Modifier**  
0 - Standard Assembly (Silicone Elastomer)  
1 - Fluorosilicone Elastomer

**Mechanical Modifier**  
0 - Standard Assembly

\*Note: In-line Plug mates with all 3 receptacle types (In-line, Snap-thru, and PCB.)



Dimensions shown in mm  
Specifications and dimensions subject to change

www.ittcannon.com

# Snap/Clip-Lock Environmentally Sealed - Circular

## Engineering Quick Reference Selection Guide

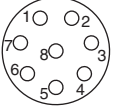
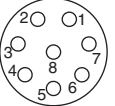
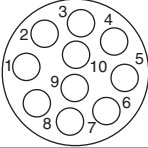
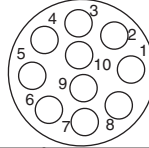
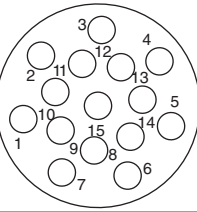
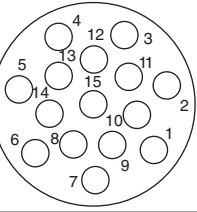
8 Position			10 Position			15 Position		
Plug		Receptacle	Plug		Receptacle	Plug		Receptacle
								
PCB	Inline	Snap-thru	PCB	Inline	Snap-thru	Snap-thru		
Snap Lock (Double)	Snap Lock (Double)	Snap Lock (Double)	Snap Lock (Double)	Snap Lock (Double)	Snap Lock (Double)	Snap Lock (Double)		
CS-210	CS-210	CS-210	CS-206	CS-206	CS-210		CS-210	
098532-0010	098532-0008	098532-0010	098532-0002 (5 A) 098532-0003 (13 A)	098532-0002 (5 A) 098532-0003 (13 A)	098532-0002 (5 A) 098532-0003 (13 A)		086-0060-000	
-	-	098533-0010	098531-0002 (5 A) 098531-0003 (13 A)	098530-0002 (5 A) 098530-0003 (13 A)	098533-0002 098533-0003		086-0059-000	
See page 14	See page 14	See page 14	See page 14	See page 14	See page 14	See page 14		

The Snap Lock Environmental Series is environmentally sealed connector created for printed circuit board, black box, cable-to-cable or bulkhead applications.

When your under-the-hood requirements call for tough performance, the SLC "snaps" into a tightly sealed connection that can withstand heat, shock and vibration. The connector is designed to preserve the integrity of the solid state package, while protecting against contaminants - even when unmated.

Gold, tin/lead plated stamped contacts add durability. A rugged, thermoplastic receptacle body maximizes performance by withstanding temperature variances from -40°C to +150°C (material rating).

The SLC series is available in 2, 5, 8, 10, 15 contact cavity configurations. It can also be adapted to robotics assembly. Should you requirement demand higher density configurations, consult Customer Service.



**Product Features and Benefits**

- Superior environmental sealing
- Material rating: -40°C to +150°C continuous operation at rated current
- Available in sizes 2, 5, 8, 10, 15 contacts
- Crimp stamped gold, tin/lead plated contacts
- Hand insertable/removable contacts
- Current rating 5 A and 13 A versions
- Low millivolt drop
- Low contact resistance
- Small footprint on P.C. board and low profile
- Adaptable to robotics assembly
- Latch with tactile and audible feedback
- Increases durability and provides for minimum installation
- Low installed cost
- Requires less PCB space

**Performance Specifications**

Contact Resistance	10mΩ maximum
Insulation Resistance	20MΩ minimum (USCAR)
Current Rating	5 A signal continuous at 150°C all contacts, 2 position 13 A power continuous at 150°C all contacts, 5 position and 10 position only
Dielectric Withstanding Voltage	1000 Vrms AC at sea level
Applicable Cannon Specification	SLC (CS-206) SLCT 5 & 10 (210) SLCT8 (216) SLCT 15 (206)
Material Rating Operating Temperature	-40°C to +150°C
Crimp Contacts	Semi-automatic or hand crimpable or fully automatic
Wire Size	20 - 16 AWG
Wire Insulation Sealing Range	1,98 (.078) to 3,30 (.130) dia.
Contact Insertion	No tool required. Suitable for automation.
Contact Extraction	Rear Removable
Contact Retention	20 lbs. Minimum per contact
Wire Strip Length	5,59 (.220) to 5,33 (.210)

**Materials and Finishes**

Connector Housing	High temperature thermoplastic
Contacts	Copper alloy
Finish	Engaging area: Gold over nickel Crimp/P.C. tail area: Tin/lead over nickel - standard offering Tin/Lead over nickel - Option #2 all over
Environmental Seal	High temperature silicone elastomer



Contact Cavity Arrangements - Mating Face View

Plug



2 Way

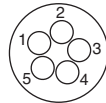

5 Way

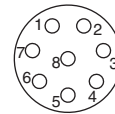

8 Way

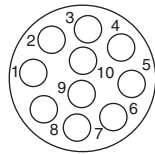

10 Way

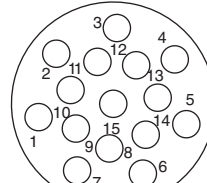

15 Way

Receptacle



2 Way

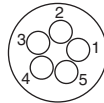

5 Way

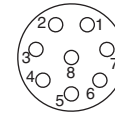

8 Way

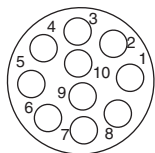

10 Way

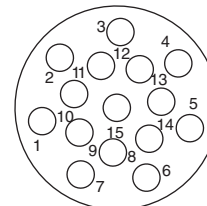

15 Way

Plug, In-line\* (Cable-to-Cable) (Type P) SLC-5, SLC-10

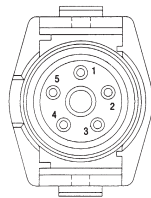
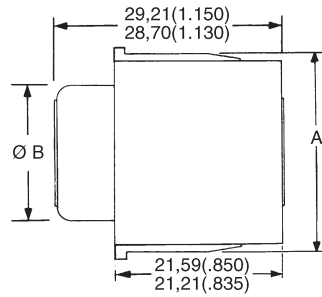

Front-Face View  
5 Cavity Housing

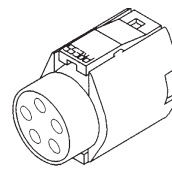

Side View  
Plug Assembly

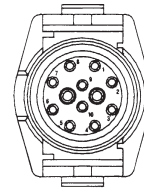

Front-Face View  
10 Cavity Housing

In-line Plug\* (Mates with SLC types R, T, and B)

Housing Size	Rating	Part Number	Description	A	ØB
5	5 A	098532-0011	SLC-5P5-00	27,81 (1.095)	18,03 (.710)
5	13 A	098532-0001	SLC-5P13-00	26,80 (1.055)	18,03 (.710)
10	5 A	098532-0002	SLC-10P5-00	34,92 (1.375)	24,15 (.990)
10	13 A	098532-0003	SLC-10P13-00	34,04 (1.340)	25,15 (.990)

\*Contact lead assemblies are customer terminated and installed. See page 14, part numbers 110238-0488, 110238-2003.

Receptacle, In-line\* (Cable-to-Cable) (Type R) SLC-5, SLC-10

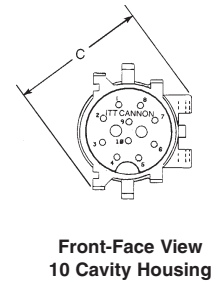
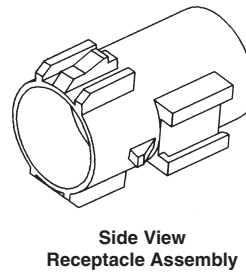
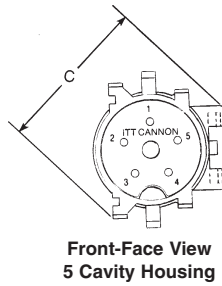
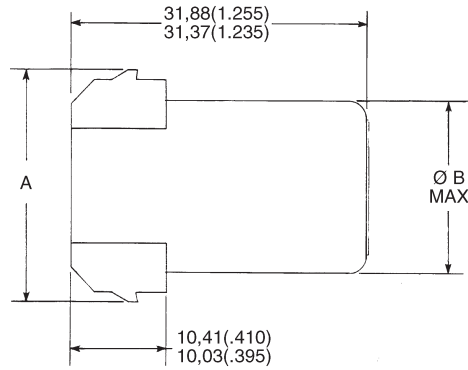

In-line Receptacle\* (Mates with SLC type P)

Housing Size	Rating	Part Number	Description	A	ØB	C Ref.
5	5 A	098530-0000	SLC-5R5-00	24,13 (.950)	18,03 (.710)	24,38 (.960)
5	13 A	098530-0001	SLC-5R13-00	23,75 (.935)	18,03 (.710)	24,38 (.960)
10	5 A	098530-0002	SLC-10R5-00	31,24 (1.230)	25,15 (.990)	31,62 (1.245)
10	13 A	098530-0003	SLC-10R13-00	30,86 (1.215)	25,15 (.990)	31,62 (1.245)

\*Contact lead assemblies are customer terminated and installed. See page 16, part numbers 110238-0446, 110238-2004.

Square Flange



Snaps onto Type R and B connectors

Materials and Finishes  
Material: Thermoplastic  
Color: Black

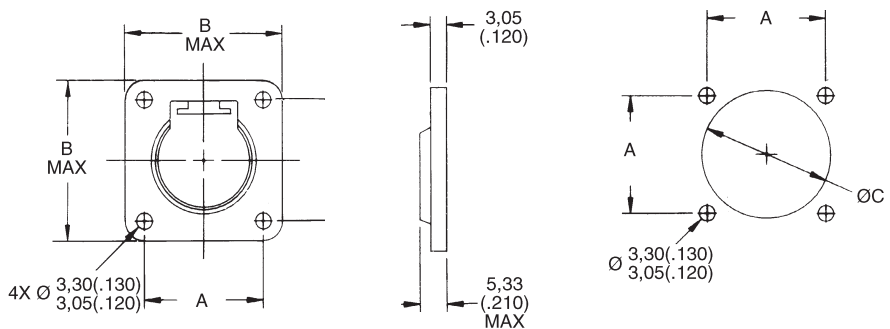

Housing Size	Part Number	A	B Max.	ØC
5	066-9504.000	23,37 (.920)	31,24 (1.230)	32,51 - 31,75 (1.280 - 1.250)
10	066-9504-001	28,45 (1.120)	36,32 (1.430)	25,40 - 24,64 (1.000 - .970)

Receptacle, Snap-thru\* (Type T) SLC-5, SLC-10

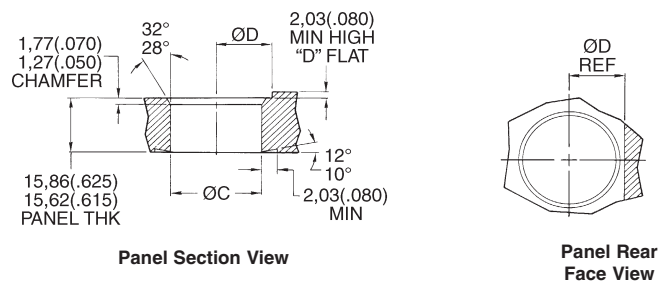
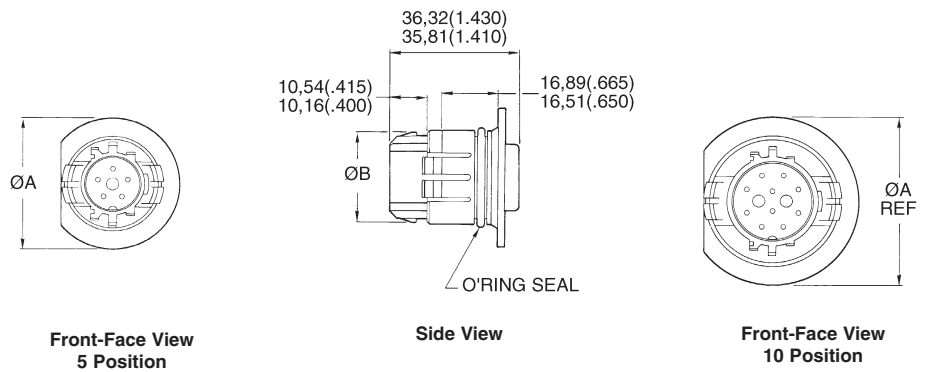

Snap-thru Receptacle\* (Mates with SLC Type P)

Housing Size	Rating	Part Number	Description	$\varnothing A$	$\varnothing B$	$\varnothing C$	$\varnothing D$
5	5 A	098533-0000	SLC-5T5-00	37,21 (1.465)	24,13 (.950)	25,60 (1.008)	15,62 (.615)
5	13 A	098533-0001	SLC-5T13-00	36,96 (1.455)	23,75 (.935)	25,48 (1.003)	15,34 (.605)
10	5 A	098533-0002	SLC-10T5-00	47,62 (1.875)	31,24 (1.230)	35,05 (1.380)	20,19 (.795)
10	13 A	098533-0003	SLC-10T13-00	47,37 (1.865)	30,86 (1.215)	34,92 (1.375)	19,94 (.785)

\*Contact lead assemblies are customer terminated and installed. See page 14, part numbers 110238-0446, 110238-2004.

Receptacle, PCB\* (Type B) SLC-5, SLC-10

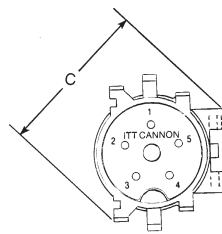
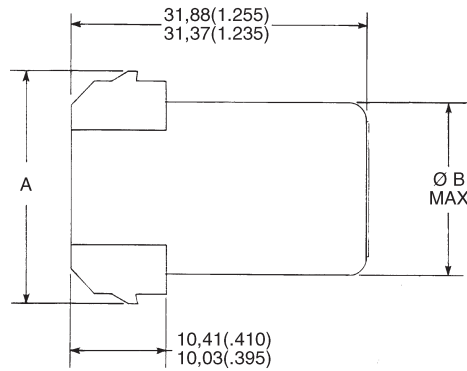

Front-Face View  
5 Cavity Housing

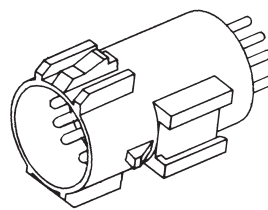

Side View  
In-Line Receptacle  
With PCB Contacts

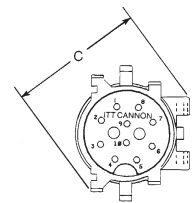

Front-Face View  
10 Cavity Housing

In-line Receptacle\* (Mates with SLC Type P)

Size	Rating	Part Number	Description	A	ØB	C Ref.
5	5 A	098531-0000	SLC-5B5-00	24,13 (.950)	18,03 (.710)	24,38 (.960)
5	13 A	098531-0001	SLC-5B13-00	23,75 (.935)	18,03 (.710)	24,38 (.960)
10	5 A	098531-0002	SLC-10B5-00	31,24 (1.230)	25,15 (.990)	31,62 (1.245)
10	13 A	098531-0003	SLC-10B13-00	30,86 (1.215)	25,15 (.990)	31,62 (1.245)

\*PCB Contacts are factory installed.

Recommended PCB Layout

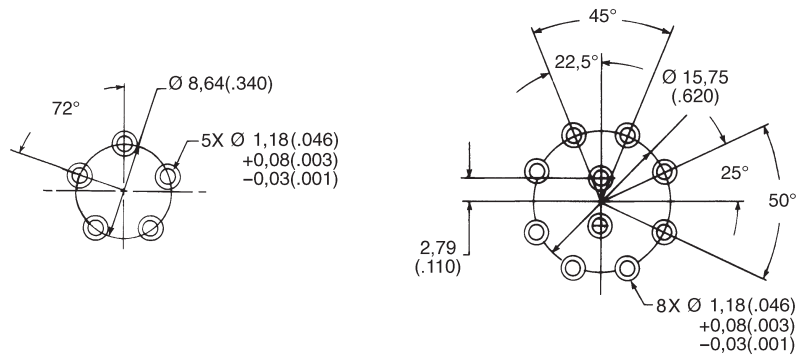



**Receptacle, Snap-thru SLCT-8**

Part No.: 098533-0010 (mates with 098532-0008)

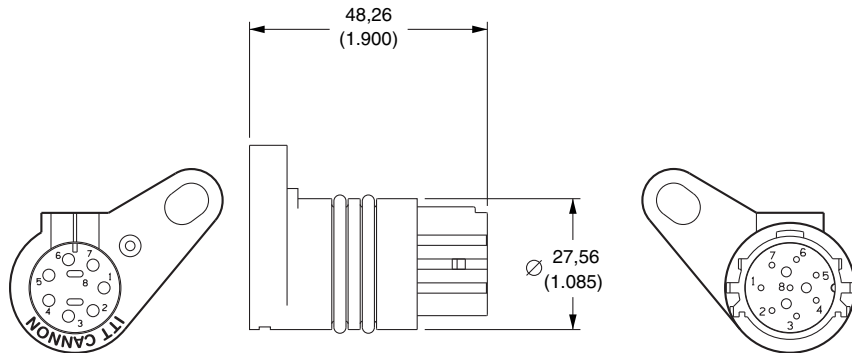

**Receptacle, Feed-thru CLC-2**

Part No.: 086-0057-000

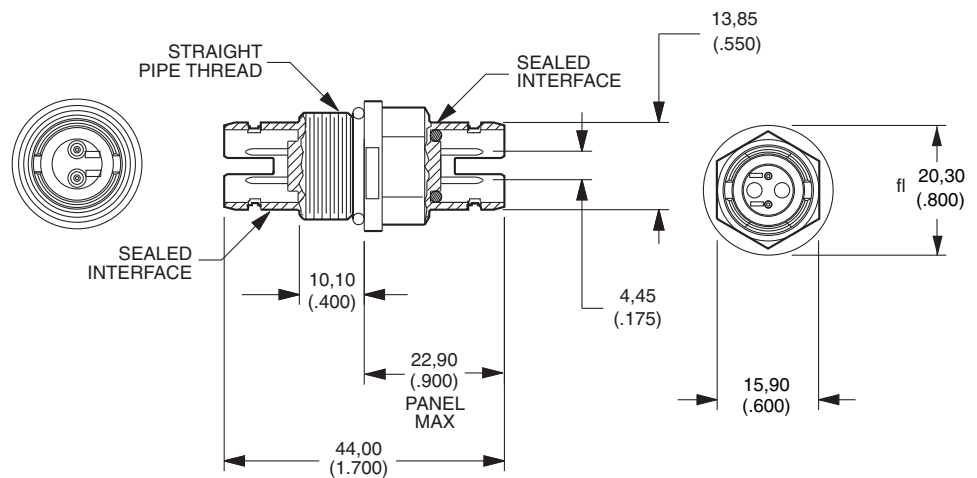

Note: In-line plug and receptacle available.

**Plug, Feed-thru CLC-2**

- Part No.: 086-0058-000  
With Silicone Grommet Seal
- Part No.: 086-0058-001  
With Silicone Grommet Seal
- Part No.: 086-0058-002  
With Fluorosilicone Seal

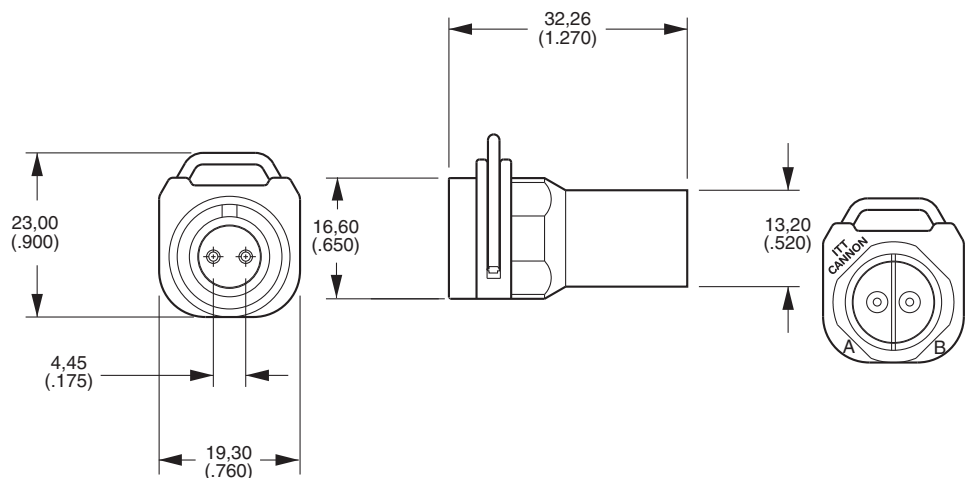

Right Angle CLC and CLC Y-Splice, please contact Product Management.



Dimensions shown in mm  
Specifications and dimensions subject to change

www.ittcannon.com

**Plug, Snap-thru SLC-15**

Part Number: 086-0060-000

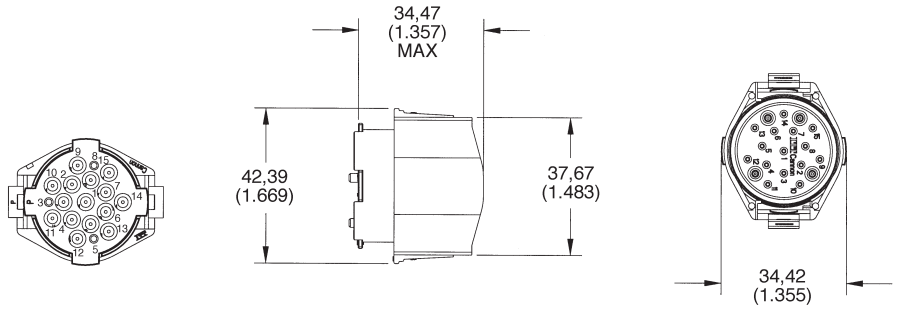

**Receptacle, Snap-thru SLC-15**

Part Number: 086-0059-000

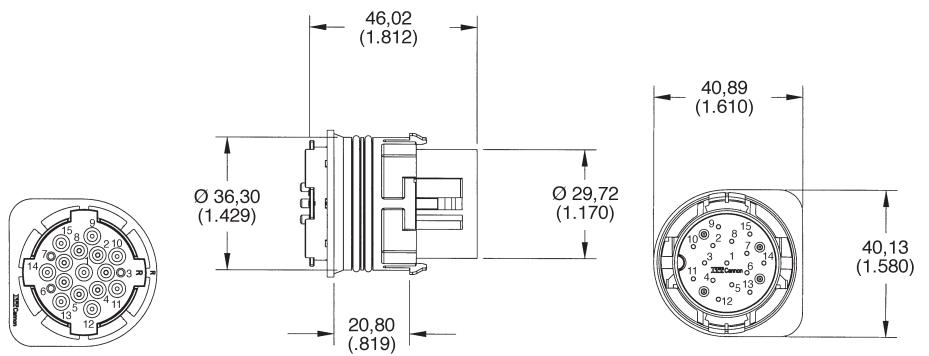

Consult factory for alternate layouts.

Contacts, Stamped, 5 and 13 Amp

Socket (use in plugs)

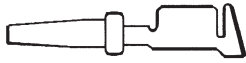

Hooded Socket

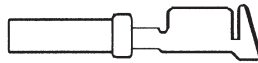

Pin (use in receptacles)

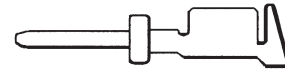

Description	Hooded Socket		Reeled	
	Socket Part Number	Pin Part Number	Socket Part Number	Number of Contacts
5 A	110238-1016 (030-2480-007)	110238-0446 (030-2464-007)	110238-0488 (030-2480-000)	4,500
13 A		110238-2004 (030-2464-003)	110238-2003 (030-2480-003)	4,000

Accessories

Sealing Plugs



Material: Thermoplastic, Color: Natural  
 Part Number: 225-0093-000  
 +125°C Rating

Connector Clip

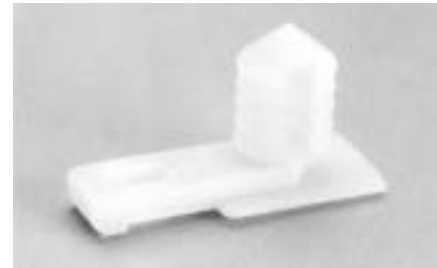

Material: Thermoplastic, Color: Natural  
 Part Number: 225-0093-000  
 +125°C Rating

Mounting Hardware for use on In-line Receptacle  
 (Cable-to-Cable) (Type R)  
 Fits Ø6,35 (.250) hole x 0,51 (.020) thick panel.

**Extraction Tool**

**Contact Extraction Tool**  
 Part Number: 274-7068-001  
 Tip Part Number: 323-9519-000



A Standard CET - SLE/SLC is available for extraction of the individual crimp contacts. Insertion tool is not required.

**Insertion / Extraction Instructions for Crimp Contacts**

**Insertion Tool**  
 No insertion tool is required. The contact is easily snapped in from the rear of the connector manually.



1. Move to the rear of the connector so that the contact cavities can be identified.



2. Insert a crimp terminated assembly into a selected cavity.



3. Continue the forward movement until and audible snap can be felt and heard. Slight pull in the opposite direction will confirm complete insertion.

**Extraction**



1. Open the CET - SLC Extraction tool and place it over the insulation of the wire.



2. Using a straight motion forward, insert the tool along the wire until it bottoms against the connector. (Do not use a screwing motion - damage will result.)



3. While the extraction tool is in place, simply pull the wire/contact assembly out.



4. Remove the extraction tool. Extraction is complete.

Hand Crimp Tool Operation



Hand Crimp Tool - CCT - SLC / SLE  
Part Number: 995-0002-232

The CCT-SLC/SLE hand crimp tool is designed to crimp individual SLC/SLE contacts on wire sizes 16, 18, and 20 AWG. Each cycle is ratchet-controlled (The tool must be completely closed before it can be reopened) to assure a satisfactory crimp each time. Over and under crimps are eliminated.

This tool is for use when the requirement is for low to moderate volume quantities, and for on-site applications where semi-automatic tools cannot be practically used.



1. Cycle the CCT - SLE / SLC hand tool to the open position.



2. While pressing upward on the locator spring, insert the contact with tails upward completely into the locator.



3. When correctly positioned the contact should be located beyond flush with the edge of the CCT - SLE / SLC and positioned in the concave polished split level crimp.



4. Partially (usually the first click) Cycle the hand tool assuring that the upward thrusting tails of the contact has started engaging with the top jaw of the tool. (There is a slight tendency for the contact to roll out of vertical alignment.)



5. Insert the pre-stripped wire into the crimp area of the contact and completely cycle the tool.



6. While pressing upward on the locator spring withdraw the crimp termination.



7. The result will be a perfect termination.



8. Note that there are no unterminated wire strands, and that some strand ends can be seen at the forward edge of the crimp. Also note the insulation is gripped by the smaller secondary crimp. Distortion is at a minimum, both axially and laterally - no sharp edges.

Wire Stripping

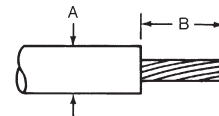

5 and 13 A Contact		
Tolerance	A	B
Low	2,41 (.095)	5,33 (.210)
High	3,30 (.130)	5,59 (.220)



## Lease Automatic Tooling - North America\*

## ABT-607 Pneumatic Crimper

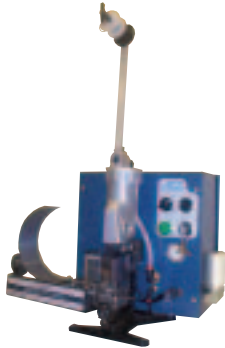

The ABT-607 is a pneumatic powered and controlled machine. It is designed for customers with moderate volume. This machine is designed to semi-automatically crimp stamped and formed contacts onto pre-stripped stranded or single conductor electrical wire. This machine will accommodate size 34 thru 12 AWG wire and is actuated by the use of a foot pedal.

**Machine Crimp Rate:**  
800 per hour

**Power Requirements:**  
Pneumatic = 100 psi, 2 cu. ft. per min.

## ABT-500 UCCD

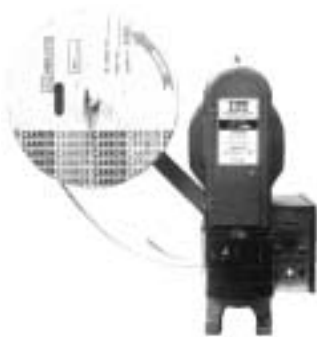

The ABT-500 Universal Cannon Crimp Die, is a flywheel driven, electronically controlled machine that is designed to semi-automatically crimp stamped and formed contacts on stranded or single conductor, pre-stripped wire. This machine will accommodate size 34 thru 12 WG wire. The machine is actuated by the use of a foot pedal.

**Machine Crimp Rate:**  
1300 per hour

**Power Requirements:**  
Electrical = 115VAC, 60Hz, 20A

## ABT-620 UCCS



The ABT-620 Universal Cannon Crimper/Stripper is a pneumatic powered, microprocessor controlled machine. It is designed to semi-automatically strip insulation from stranded or single conductor electrical wire and attach a stamped and formed contact by crimping. The machine will accommodate 34 thru 12 AWG wire. Primary application of the machine is the termination of jacketed cable where the individual leads cannot be stripped by fully automated equipment. The ABT-620 UCCS operates automatically upon insertion of a wire or it can be switched over to foot pedal operation if desired.

**Machine Crimp Rate:**  
1200+ per hour

**Power Requirements:**  
Electrical = 115VAC, 60Hz, 20A  
Pneumatic = 80 psi, 3 cu. ft. per min.

\* For other geographical regions, contact Cannon for details.

**Crimp Pot Cross Section**

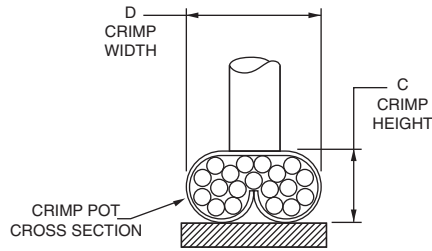

The wire crimp heights listed are only reference and valid for the correspondingly listed wire size, wire plating and wire stranding.

The wire crimp tensile values must be used to assure the performance of crimped contacts.

For wire crimp information not listed in this table, please contact Cannon.

**Crimp Height and Width**

	Wire Gauge (AWG)					
	16		18		20	
	C*	D Ref.	C*	D Ref.	C*	D Ref.
Signal (5A)	.064*	.082	.056*	.080	.054*	.080
Power (13A)	.066*	.082	.062*	.080	.058*	.080

\* Hand Tools are ± .002 and machines are ± .001

**Insulation Height and Width**

	Wire Gauge (AWG)					
	16		18		20	
	Height	Width	Height	Width	Height	Width
	Max	Max**	Max	Max**	Max	Max**
Signal (5A)	.110	.115**	.105	.110**	.105	.110**
Power (13A)	.110	.115**	.105	.110**	.105	.110**

\*\* Measurements are taken without crimping wire insulation.

**Crimp Tensile Strength**

**Wire Trim Dimension**



Wire Size (AWG)	16	18	20
Tensile Min (lbs)	35 lbs.	25 lbs.	20lbs.



**Test Parameters**

SLC Products are designed to meet Cannon specifications CS-206, CS-210, and CS-216. Items of most general interest to users are designers are listed below.

Test Description	Reference Paragraph	Requirements																																										
<b>Environmental Sealing</b>	3.2.3.5 3.2.3.6 3.2.3.7 3.2.3.8 3.2.3.9 3.2.3.2	Sand and Dust MIL-STD-202 Method 110 Test Condition A 5% salt spray 96 hours 10 cycles of 24 hours, 90-98% humidity Steam Cleaning/Pressure Wash 95°C, 375 Cycles 750 PSIG Solvent Resistance/Immersion (see 3.2.3.9) Thermal Shock 100 Cycles -40°C to +150°C ± 3°C																																										
<b>Contact Crimp Tensile Strength</b>	3.2.2.1	The minimum tensile load required to separate the wire from the contact, either by pulling the wire out of the crimp joint or by breaking the wire within the crimp joint shall not be less than the applicable limits as specified. Wire breakage or contact damage not due to crimping at less than tensile loads shall not constitute a failure. <table border="1" style="margin-left: auto; margin-right: auto;"> <thead> <tr> <th>Wire Size AWG</th> <th>Crimp Tensile Strength, Pounds Minimum</th> </tr> </thead> <tbody> <tr> <td>16</td> <td>35</td> </tr> <tr> <td>18</td> <td>25</td> </tr> <tr> <td>20</td> <td>20</td> </tr> </tbody> </table>	Wire Size AWG	Crimp Tensile Strength, Pounds Minimum	16	35	18	25	20	20																																		
Wire Size AWG	Crimp Tensile Strength, Pounds Minimum																																											
16	35																																											
18	25																																											
20	20																																											
<b>Insulation Resistance</b>	3.2.1.1	Mated and wired connectors shall exhibit an insulation resistance greater than 100 megohms between all contacts. This limit shall apply after exposure to each environment including salt solution immersion. Tests shall be performed at 100 VDC ± 10%.																																										
<b>Dielectric Withstanding Voltage</b>	3.2.1.2	Wired and mated connectors shall show no evidence of breakdown between adjacent contacts when tested at 1000 VDC ± 5%. Connectors shall meet this requirement after exposure to each environment. Current leakage shall be less than 1.0 milliamp.																																										
<b>Low Level Contact Resistance</b>	3.2.1.4	The low level contact resistance of mated contacts shall be less than 10 milliohms when measured across the contacts and crimp joints. The test current shall be a maximum of 100 milliamps with an open circuit test voltage of 20 millivolts maximum.																																										
<b>Mechanical Shock</b>	3.2.3.3	Connectors shall be subjected to three shocks in each direction applied along the three mutually perpendicular axes of the connector test specimen for a total of 12 shocks. Each shock shall consist of a terminal peak sawtooth pulse with a peak value of 100 g's and a duration of 6 milliseconds.																																										
<b>Vibration</b>	3.2.3.4	Connectors shall be subjected to random vibration in accordance with MIL-STD-1344, Method 2005.1, test condition VI for 20 hours along each of the following three axes: <table border="1" style="margin-left: auto; margin-right: auto;"> <thead> <tr> <th>Direction</th> <th>Grms</th> </tr> </thead> <tbody> <tr> <td>Radial axis of connector (Y)</td> <td>10.2</td> </tr> <tr> <td>Longitudinal axis of connector (Z)</td> <td>10.2</td> </tr> </tbody> </table> Electrical continuity of the connectors shall be monitored during the last 20 minutes sweep in each axis with a test current of 100 milliamps or less and a test voltage less than 2VDC. Electrical discontinuities in excess of 10 microseconds shall be cause of failure.	Direction	Grms	Radial axis of connector (Y)	10.2	Longitudinal axis of connector (Z)	10.2																																				
Direction	Grms																																											
Radial axis of connector (Y)	10.2																																											
Longitudinal axis of connector (Z)	10.2																																											
<b>Durability</b>	3.2.2.6	Connectors shall be subjected to 25 cycles of mating and unmating at room temperature. Following this test there shall be no evidence of damage to the contacts, contact plating, connector housing or seals which may prove detrimental to reliable performance of the connector.																																										
<b>Contact</b>	3.2.2.2	Contacts shall not be displaced greater than 0.030 inches from the connector body when a force of 10 pounds is applied. When this test follows maintenance again the same contacts shall be tested.																																										
<b>Maintenance Aging</b>	3.2.2.3	Consist of subjecting each wired receptacle to 5 cycles of removal and reinsertion of 20% of the contacts or a minimum of 5 per connector with approved tooling.																																										
<b>Mating and Separating Force</b>	3.2.2.4	The maximum force required to mate the plug and receptacle shall be 10 pounds. The maximum force required to separate the plug and receptacle shall be 5 pounds. The rate of travel shall be one inch per minute.																																										
<b>Solvent Resistance Immersion</b>	3.2.2.9	<b>Connectors shall be subjected to the following fluids at the temperature and length of time specified. Following the fluid dip or immersion, the connectors shall be immersed to a depth of 2 to 12 inches in a 5% salt-water solution for 24 hours at room temperature. At the completion of the salt-water immersion test, while still immersed, the connectors shall meet the insulation resistance requirement specified herein.</b> <table border="1" style="margin-left: auto; margin-right: auto;"> <thead> <tr> <th>Fluid</th> <th>Method</th> <th>Temperature</th> </tr> </thead> <tbody> <tr> <td>No. 2 Diesel Fluid</td> <td>Immersion (2)</td> <td>140°F</td> </tr> <tr> <td>Methyl Alcohol</td> <td>Dip (1)</td> <td>Room Temperature</td> </tr> <tr> <td>Antifreeze</td> <td></td> <td></td> </tr> <tr> <td>- Prestone</td> <td>Immersion (2)</td> <td>180°F</td> </tr> <tr> <td>- 50% Water/50%</td> <td>Immersion (2)</td> <td>180°F</td> </tr> <tr> <td>Ethylene Glycol</td> <td></td> <td></td> </tr> <tr> <td>Degreaser</td> <td></td> <td></td> </tr> <tr> <td>- Gunk</td> <td>Dip (1)</td> <td>Room Temperature</td> </tr> <tr> <td>- Mineral Spirits</td> <td>Dip (1)</td> <td>Room Temperature</td> </tr> <tr> <td>Paint (Oil Base)</td> <td>Immersion (2)</td> <td>Room Temperature</td> </tr> <tr> <td>Lubricating Oil (SAE 10 W40)</td> <td>Immersion (2)</td> <td>200°F</td> </tr> <tr> <td>Brake Fluid (Delco Supreme)</td> <td>Dip (1)</td> <td>Room Temperature</td> </tr> <tr> <td>Transmission Fluid fully submerged and pressurized @ 7 psi. (Dextron)</td> <td>Dip (1)</td> <td>Room Temperature</td> </tr> </tbody> </table> (1) Dip: Connectors shall withstand a one second dip and a three minute air dry for a total of 80 cycles. (2) Immersion: Connectors shall withstand immersion for one hour.	Fluid	Method	Temperature	No. 2 Diesel Fluid	Immersion (2)	140°F	Methyl Alcohol	Dip (1)	Room Temperature	Antifreeze			- Prestone	Immersion (2)	180°F	- 50% Water/50%	Immersion (2)	180°F	Ethylene Glycol			Degreaser			- Gunk	Dip (1)	Room Temperature	- Mineral Spirits	Dip (1)	Room Temperature	Paint (Oil Base)	Immersion (2)	Room Temperature	Lubricating Oil (SAE 10 W40)	Immersion (2)	200°F	Brake Fluid (Delco Supreme)	Dip (1)	Room Temperature	Transmission Fluid fully submerged and pressurized @ 7 psi. (Dextron)	Dip (1)	Room Temperature
Fluid	Method	Temperature																																										
No. 2 Diesel Fluid	Immersion (2)	140°F																																										
Methyl Alcohol	Dip (1)	Room Temperature																																										
Antifreeze																																												
- Prestone	Immersion (2)	180°F																																										
- 50% Water/50%	Immersion (2)	180°F																																										
Ethylene Glycol																																												
Degreaser																																												
- Gunk	Dip (1)	Room Temperature																																										
- Mineral Spirits	Dip (1)	Room Temperature																																										
Paint (Oil Base)	Immersion (2)	Room Temperature																																										
Lubricating Oil (SAE 10 W40)	Immersion (2)	200°F																																										
Brake Fluid (Delco Supreme)	Dip (1)	Room Temperature																																										
Transmission Fluid fully submerged and pressurized @ 7 psi. (Dextron)	Dip (1)	Room Temperature																																										
<b>Temperature Life</b>	3.2.3.1	Connectors shall be subjected to a temperature of 150°C ± 3°C for a period of 1000 hours. At the end of the temperature soak period and after removal from the chamber, the connectors shall meet the insulation resistance and dielectric withstanding voltage requirements specified herein. Connectors shall be operated at rated current throughout the duration of the temperature life test. Upon removal from the chamber at the conclusion of the test, the connectors shall show no visual signs of damage, which may be detrimental to the performance of the connector.																																										
<b>Thermal Cycling</b>	3.2.3.2	Connectors shall be subjected to 100 thermal cycles from -40°C to +150°C. One cycle shall consist of the transitions from room temperature to -40°C to +150°C, and from 150°C to room temperature. One cycle shall be accomplished in a three-hour period with a minimum stabilization period of 15 minutes at each temperature extreme. The chamber temperature transition rate shall be a minimum of 1.30°C per minute and a maximum of 6.00°C per minute.																																										

Specifications and dimensions subject to change

