



SURFACE MOUNT DEVICE LED

Part No. : L-C150KRCT

REV:A / 0

● PACKAGE OUTLINE DIMENSIONS

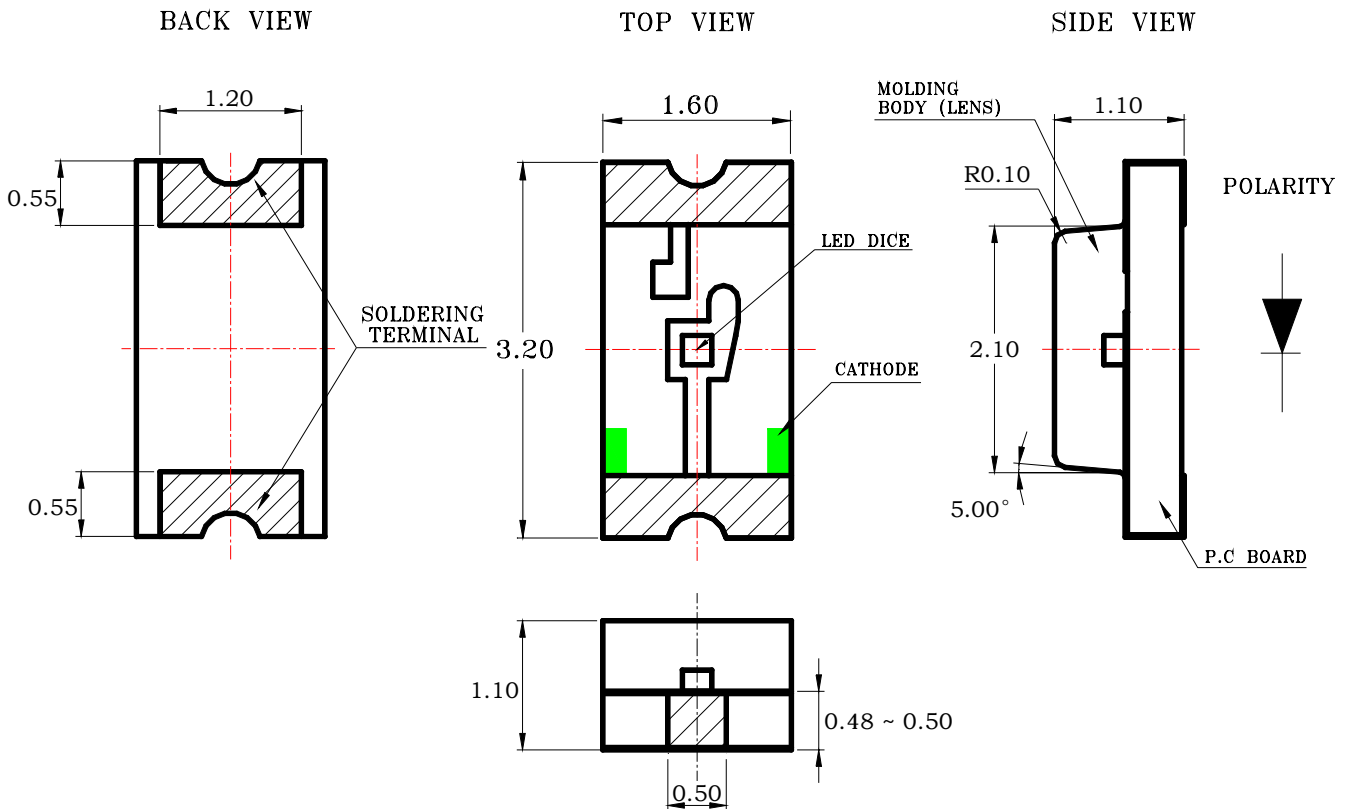

Notes:

1. All dimensions are in millimeters.
2. Tolerance is $\pm 0.1\text{mm}$ (.004") unless otherwise noted.

● Features

- * Top view, wide view angle, single color Chip LED.
- * Package in 8mm tape on 7" diameter reels.
- * Compatible with automatic Pick & Place equipment.
- * Compatible with Infrared and Wave soldering reflow solder processes.
- * EIA STD package.
- * I.C. compatible.



SURFACE MOUNT DEVICE LED

Part No. : L-C150KRCT

REV:A / 0

● Chip Materials

- * Dice Material : AlInGaP
- * Light Color : Super Red
- * Lens Color : Water Clear

● Absolute Maximum Ratings(Ta=25°C)

| Symbol | Parameter | Rating | Unit |
|--------|--|---------------------|-------|
| PD | Power Dissipation | 75 | mW |
| IPF | Peak Forward Current (1/10 Duty Cycle, 0.1ms Pulse Width) | 80 | mA |
| IF | Continuous Forward Current | 30 | mA |
| - | De-rating Linear From 25°C | 0.25 | mA/°C |
| VR | Reverse Voltage | 5 | V |
| ESD | Electrostatic Discharge Threshold(HBM) ^{Note A} | 2000 | V |
| Topr | Operating Temperature Range | -40 ~ +85 | °C |
| Tstg | Storage Temperature Range | -40 ~ +85 | °C |
| - | Wave Soldering Condition (Two times Max.) | 260 (for 5 seconds) | °C |
| - | Infrared Soldering Condition (Two times MAX.) | 240 (for 5 seconds) | °C |

Note A :

HBM : Human Body Model. Seller gives no other assurances regarding the ability of to withstand ESD.

● Electro-Optical Characteristics(Ta=25°C)

| Parameter | Symbol | Min. | Typ. | Max. | Unit | Test Condition |
|--------------------------|---------|------|------|------|------|-------------------|
| Luminous Intensity | IV | 16.0 | 40.0 | 80.0 | mcd | IF=20mA |
| Viewing Angle | 2 θ 1/2 | | 130 | | deg | Note 2 |
| Peak Emission Wavelength | λ p | | 639 | | nm | Measurement @Peak |
| Dominant Wavelength | λ d | | 631 | | nm | IF=20mA |
| Spectral Line Half-Width | Δ λ | | 17 | | nm | |
| Forward Voltage | VF | | 2.0 | 2.4 | V | IF =20mA |
| Reverse Current | IR | | | 100 | μ A | VR = 5V |



SURFACE MOUNT DEVICE LED

Part No. : L-C150KRCT

REV:A / 0

Notes:

1. Luminous intensity is measured with a light sensor and filter combination that proximates the CIE eye-response curve.
2. $\theta_{1/2}$ is the off-axis angle at which the luminous intensity is half the axial luminous intensity.
3. The dominant wavelength λ_d is derived from the CIE chromaticity diagram and represents the single wavelength which defines the color of the device.
4. Caution in ESD :
Static Electricity and surge damages the LED. It is recommend use a wrist band or anti-electrostatic glove when handling the LED. All devices, equipment and machinery must be properly grounded.
5. Major standard testing equipment by "Instrument System" Model : CAS140B Compact Array Spectrometer and "KEITHLEY" Source Meter Model : 2400.

● Typical Electro-Optical Characteristics Curves

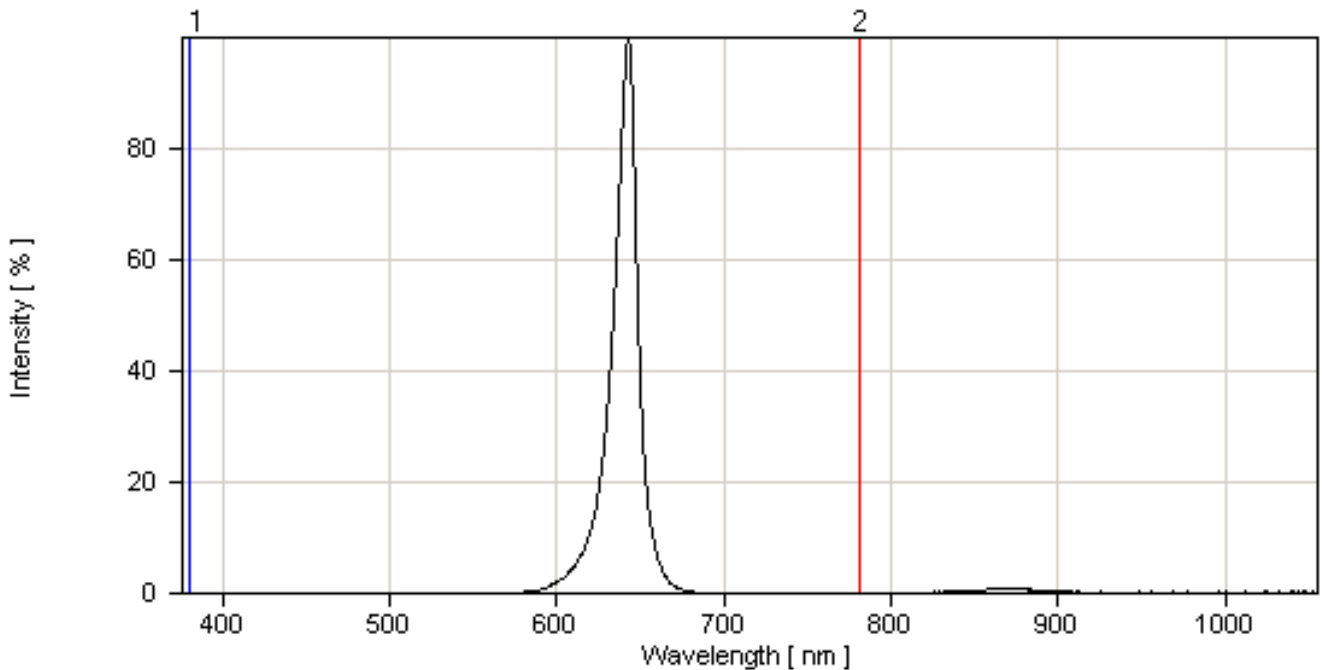

Fig.1 Relative Intensity vs. Wavelength



SURFACE MOUNT DEVICE LED

Part No. : L-C150KRCT

REV:A / 0

● Typical Electro-Optical Characteristics Curves

(25°C Ambient Temperature Unless Otherwise Noted)

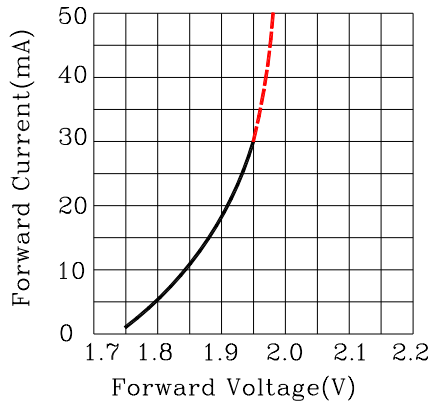

Fig.2 Forward Current vs. Forward Voltage

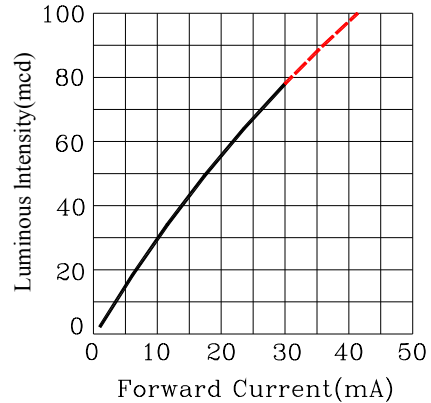

Fig.3 Luminous Intensity vs. Forward Current

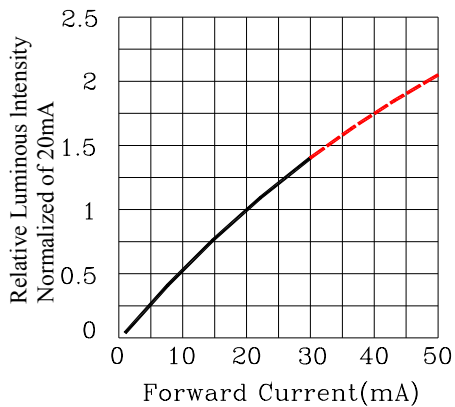

Fig.4 Relative Luminous Intensity vs. Forward Current

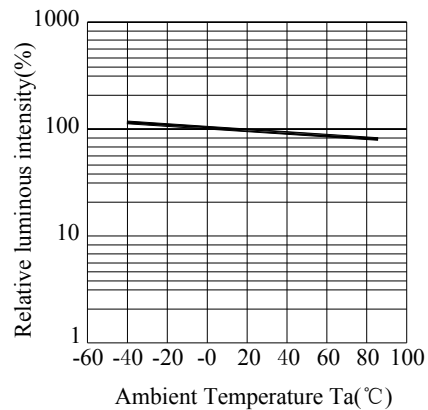

Fig.5 Luminous Intensity VS Ambient Temperature

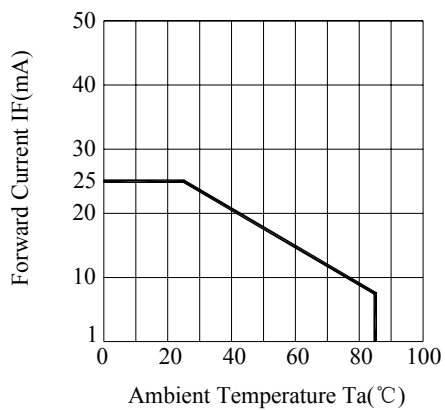

Fig.6 Forward Current Derating Curve

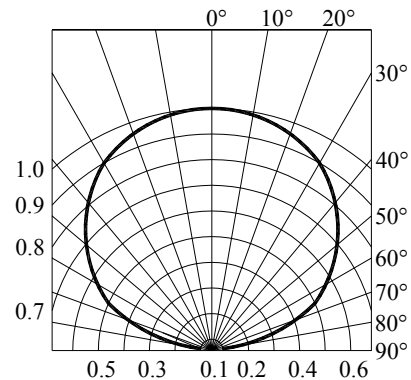

Fig.7 Forward Current Derating Curve



SURFACE MOUNT DEVICE LED

Part No. : L-C150KRCT

REV:A / 0

● Label Explanation

BATCH: L1 B9 AC

L1: Luminous Intensity Code

B9: Forward Voltage Code

AC: Dom Wavelength Code

● Reel Dimensions

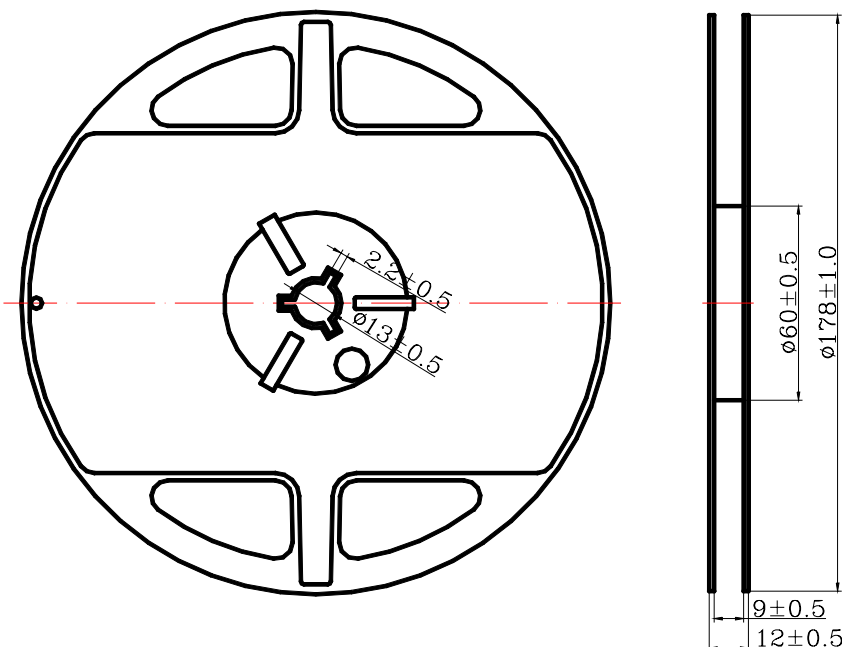

Notes:

1. Taping Quantity : 3000PCS

2. The tolerances unless mentioned is ± 0.1 mm, Angle $\pm 0.5^\circ$, Unit : mm.



SURFACE MOUNT DEVICE LED

Part No. : L-C150KRCT

REV:A / 03

● Package Dimensions Of Tape And Reel

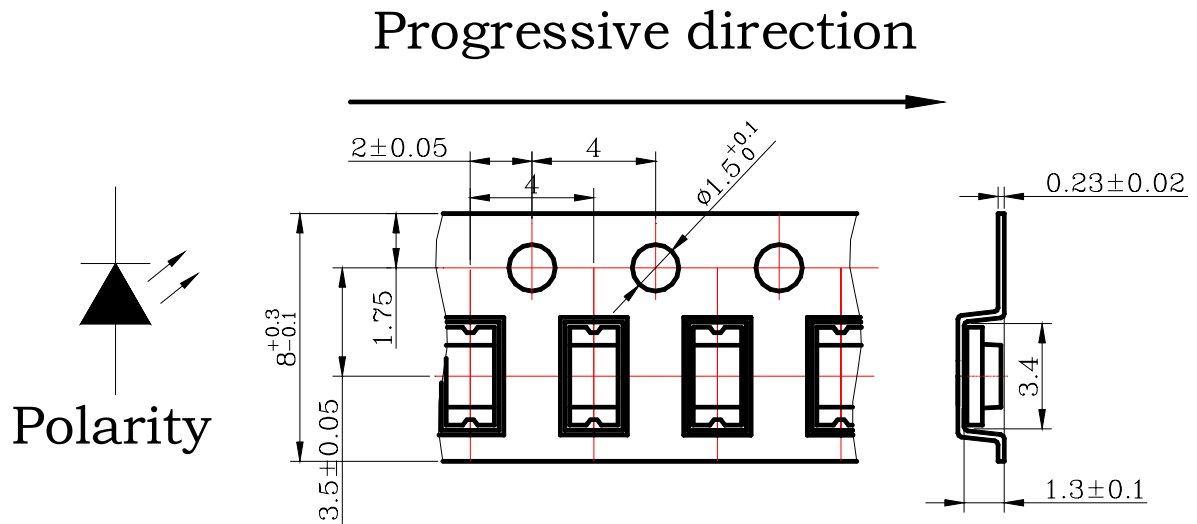

Notes: All dimensions are in millimeters.

Moisture Resistant Packaging

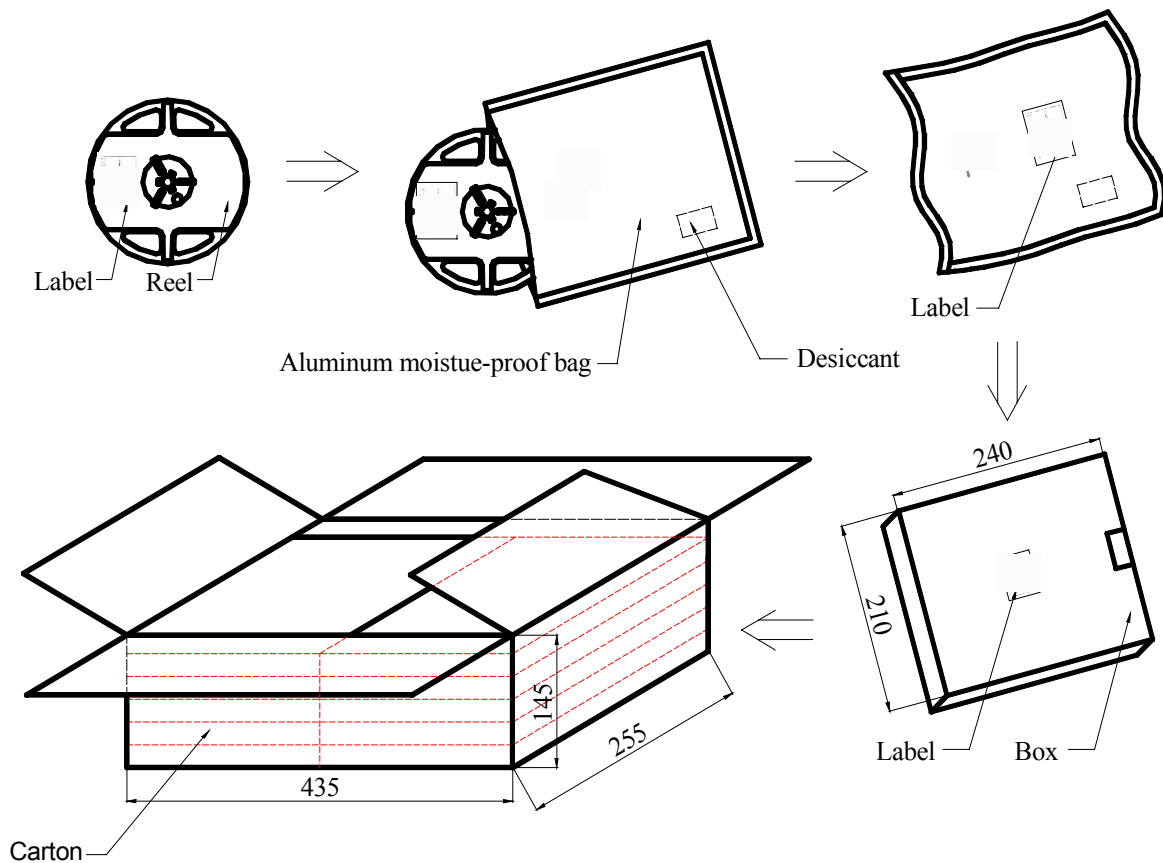

Notes : One reel in a bag, one bag in a inner box, ten inner boxes in a carton. Unit : mm.



SURFACE MOUNT DEVICE LED

Part No. : L-C150KRCT

REV:A / 0

● Cleaning

- * If cleaning is required, use the following solutions for less than 1 minute and less than 40°C.
- * Appropriate chemicals: Ethyl alcohol and isopropyl alcohol.
- * Effect of ultrasonic cleaning on the LED resin body differs depending on such factors as the oscillator output, size of PCB and LED mounting method. The use of ultrasonic cleaning should be enforced at proper output after confirming there is no problem.

● Suggest Soldering Pad Dimensions

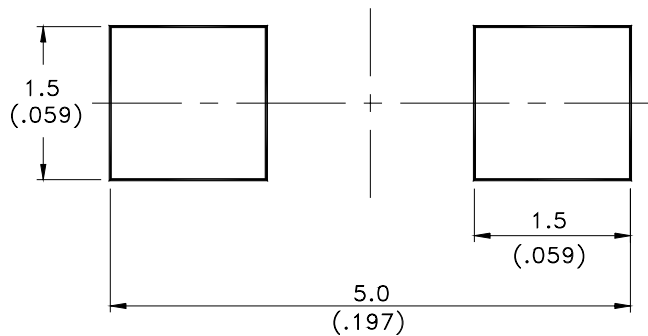

Direction of PWB camber
and go to reflow furnace

● Suggest IR Reflow Soldering Profile Condition:

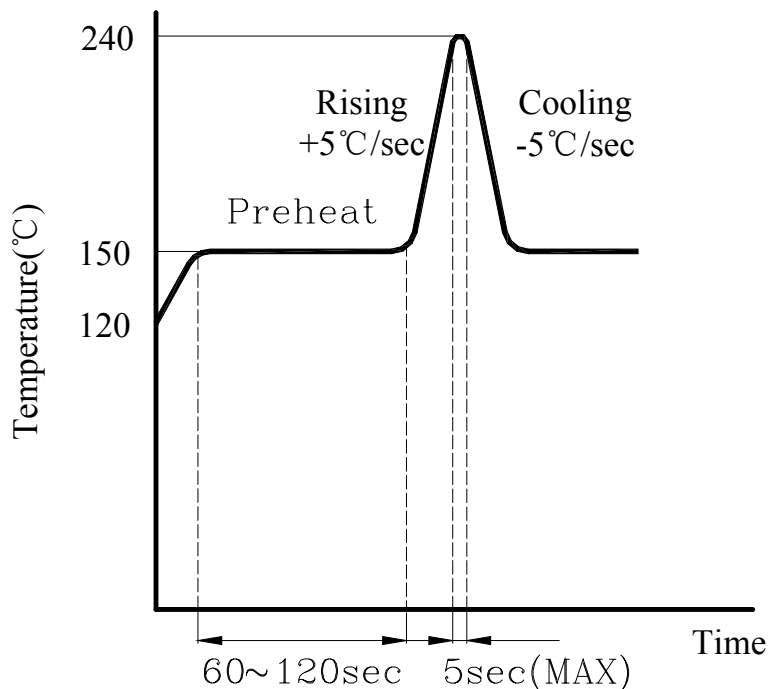



SURFACE MOUNT DEVICE LED

Part No. : L-C150KRCT

REV:A / 0

● Bin Code List

| Luminous Intensity(IV), Unit:mcd@20mA | | |
|---------------------------------------|------|------|
| Bin Code | Min | Max |
| M | 16.0 | 32.0 |
| N | 25.0 | 50.0 |
| P | 40.0 | 80.0 |
| | | |

Including test tolerance

● CAUTIONS

1.Application Limitation :

The LED's described here are intended to be used for ordinary electronic equipment (such as office equipment, communication equipment and household application).Consult HB's sales in advance for information on application in which exceptional quality and reliability are required, particularly when the failure or malfunction of the LED's may directly jeopardize life or health (such as airplanes, automobiles, traffic control equipment, life support system and safety devices).

2.Storage :

Before opening the package :

The LEDs should be kept at 30°C or less and 85%RH or less. The LEDs should be used within a year.

After opening the package :

The LEDs should be kept at 30°C or less and 70%RH or less. The LEDs should be soldered within 168 hours(7 days) after opening the package.

Please avoid rapid transitions in ambient temperature in high humidity environments where condensation may occur.

3.Soldering

Do not apply any stress to the lead frame during soldering while the LED is at high temperature. Recommended soldering condition.

Reflow Soldering :

Pre-heat 120~150°C, 120sec. MAX., Peak temperature : 240°C Max. Soldering time : 10 sec Max.

Soldering Iron : (Not recommended)

Temperature 300°C Max., Soldering time : 3 sec. Max.(one time only), power dissipation of iron : 20W Max. use SN60 solder of solder with silver content and don't to touch LED lens when soldering.

Wave soldering :

Pre-heat 100°C Max, Pre-heat time 60 sec. Max, Solder wave 260°C Max, Soldering time 5 sec. Max. preformed consecutively cooling process is required between 1st and 2nd soldering processes.



SURFACE MOUNT DEVICE LED

Part No. : L-C150KRCT

REV:A / 03

4. Lead-Free Soldering

For Reflow Soldering :

- 1、Pre-Heat Temp:150-180°C,120sec.Max.
- 2、Soldering Temp:Temperature Of Soldering Pot Over 230°C,40sec.Max.
- 3、Peak Temperature:260°C , 5sec.
- 4、Reflow Repetition:2 Times Max.
- 5、Suggest Solder Paste Formula 93.3 Sn/3.1 Ag/3.1 B /0.5 Cu

For Soldering Iron (Not Recommended) :

- 1、Iron Tip Temp:350°C Max.
- 2、Soldering Iron:30w Max.
- 3、Soldering Time:3 Sec. Max. One Time.

For Dip Soldering :

- 1、Pre-Heat Temp:150°C Max. 120 Sec. Max.
- 2、Bath Temp:265°C Max.
- 3、Dip Time:5 Sec. Max.



SURFACE MOUNT DEVICE LED

Part No. : L-C150KRCT

REV:A / 0

4. Drive Method

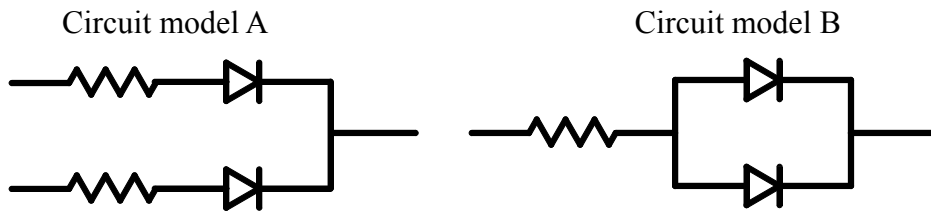

(A) Recommended circuit.

(B) The difference of brightness between LED's could be found due to the Vf-If characteristics of LED.

5. Reliability Test

| Classification | Test Item | Test Condition | Reference Standard |
|--------------------|--|--|---|
| Endurance Test | Operation Life | Ta= Under Room Temperature As Per Data Sheet Maximum Rating *Test Time= 1000HRS (-24HRS,+72HRS)*@20mA. | MIL-STD-750D:1026 (1995) MIL-STD-883D:1005 (1991) JIS C 7021:B-1 (1982) |
| | High Temperature High Humidity Storage | IR-Reflow In-Board, 2 Times Ta= 65±5°C, RH= 90~95% *Test Time= 1000HRS±2HRS | MIL-STD-202F:103B(1980) JIS C 7021:B-11(1982) |
| | High Temperature Storage | Ta= 105±5°C Test Time= 1000HRS (-24HRS,72HRS) | MIL-STD-883D:1008 (1991) JIS C 7021:B-10 (1982) |
| | Low Temperature Storage | Ta= -55±5°C *Test Time=1000HRS (-24HRS,72H RS) | JIS C 7021:B-12 (1982) |
| Environmental Test | Temperature Cycling | 105±5°C -55±5°C 10mins 10mins 100 Cycles | MIL-STD-202F:107D (1980) MIL-STD-750D:1051(1995) MIL-STD-883D:1010 (1991) JIS C 7021:A-4(1982) |
| | Thermal Shock | IR-Reflow In-Board, 2 Times 105±5°C -55°C±5°C 10mins 10mins 100 Cycles | MIL-STD-202F:107D(1980) MIL-STD-750D:1051(1995) MIL-STD-883D:1011 (1991) |
| | Solder Resistance | Tsol= 260 ± 5°C Dwell Time= 10 ± 1sec | MIL-STD-202F:210A(1980) MIL-STD-750D:2031(1995) JIS C 7021:A-1(1982) |
| | Solder ability | Tsol= 235 ± 5°C Immersion time 2±0.5 sec Immersion rate 25±2.5 mm/sec Coverage ≥95% of the dipped surface | MIL-STD-202F:208D(1980) MIL-STD-750D:2026(1995) MIL-STD-883D:2003(1991) IEC 68 Part 2-20 JIS C 7021:A-2(1982) |

6. Others:

The appearance and specifications of the product may be modified for improvement without notice.