

### Specifications

Parameter	Unit	Minimum	Typical	Maximum
Center Frequency	MHz	69.9	70	70.1
Insertion Loss	dB		26.5	28
3 dB Bandwidth	MHz	12.35	12.4	12.45
Selectivity	$\pm 400\text{kHz}$	dBc	35	43
	$\pm 600\text{kHz}$	dBc	45	60
	$\pm 1\text{MHz}$	dBc	50	60
	$\pm 5\text{MHz}$	dBc	55	60
Passband Variation	dB		0.5	1
Absolute Delay	usec		3.4	3.7
Ultimate Rejection( $f_0 \pm 15\text{MHz}$ )	dB	55	60	
Substrate Material		YZ-LiNbO <sub>3</sub>		
Ambient Temperature	°C	25		
Package Size		DIP3512 (35.2x12.7x5.2mm <sup>3</sup> )		

#### Notes:

1. All specifications are based on the test circuit shown
2. In production, devices will be tested at room temperature to a guardbanded specification to ensure electrical compliance over temperature
3. Electrical margin has been built into the design to account for the variations due to temperature drift and manufacturing tolerances
4. This is the optimum impedance in order to achieve the performance show

### Matching Configuration

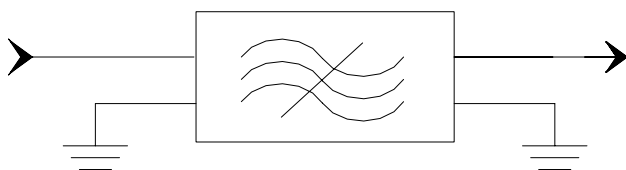



**Source/Load Impedance=50 ohm**

Notes - Component values may change depending on board layout.

	<b>SIPAT Co., Ltd.</b> ( CETC No. 26 Research Institute ) Nanping Huayuan Road No. 14 Chongqing, China, 400060	Part Number	LBN07091	
		Rev. Date	2005-3-9	
		Rev.	1.0	Page

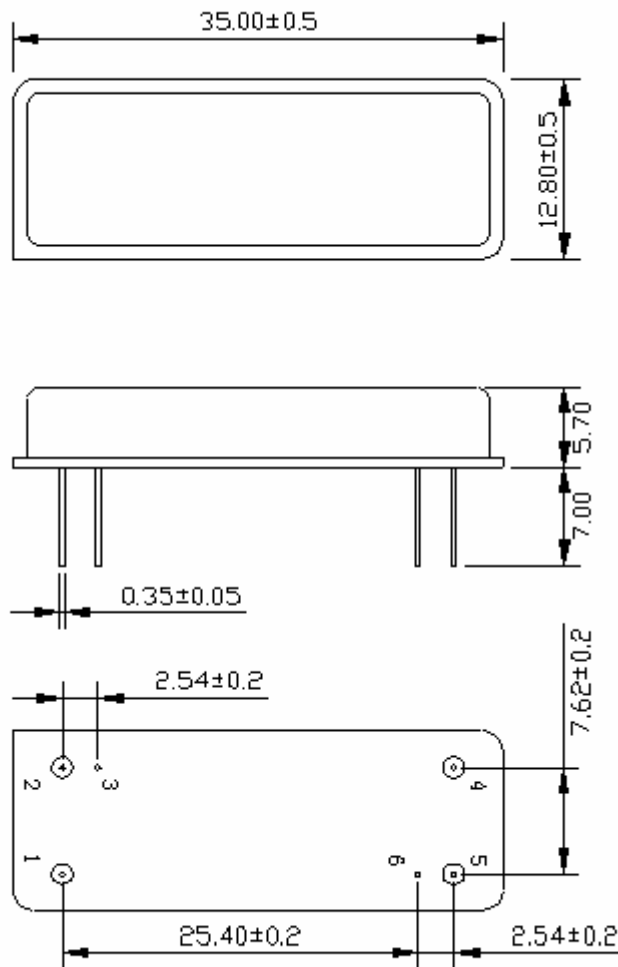
*Package Dimension*



	<b>SIPAT Co., Ltd.</b> ( CETC No. 26 Research Institute ) Nanping Huayuan Road No. 14 Chongqing, China, 400060	Part Number	LBN07091	
		Rev. Date	2005-3-9	
		Rev.	1.0	Page

Typical Performance

Frequency Respond

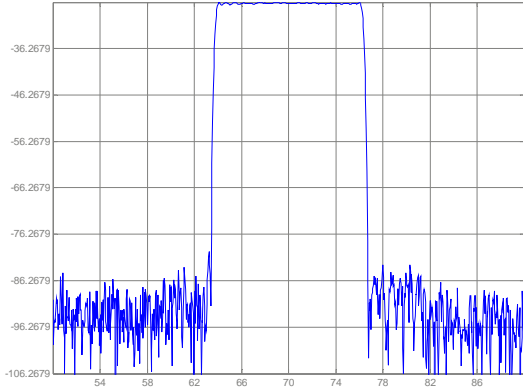

Passband Respond

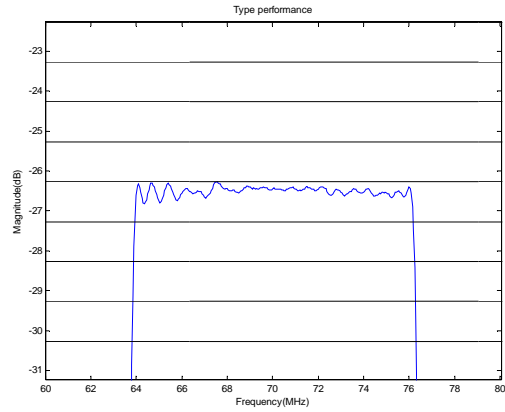

Group Delay Variation( $f_0 \pm 6.2\text{MHz}$ )

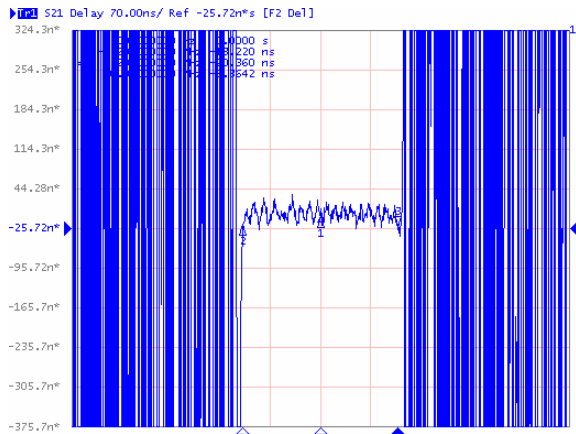

Phase Linearity( $f_0 \pm 6.2\text{MHz}$ )

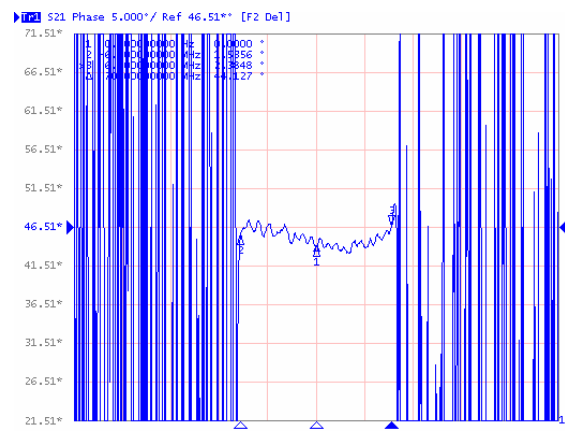

Simth Chart S11

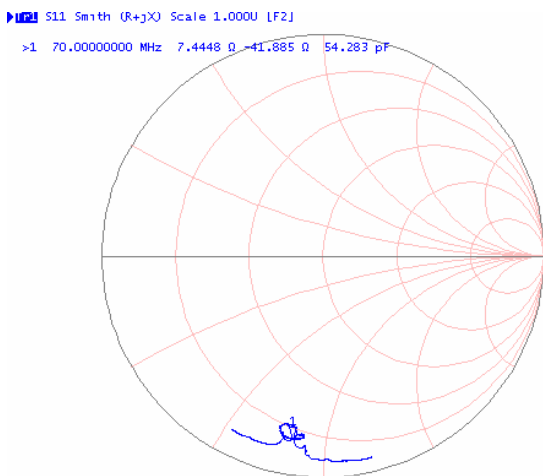

Simth Chart S22

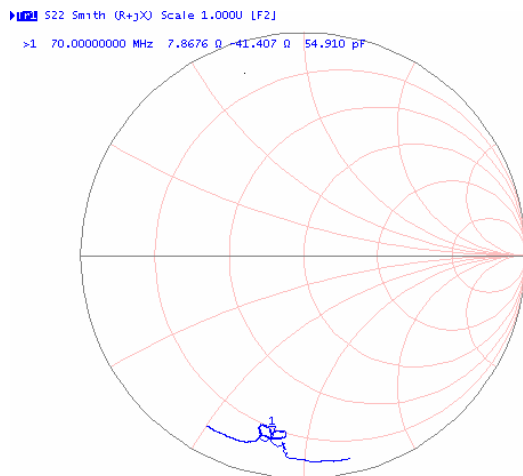

**SIPAT Co., Ltd.**  
( CETC No. 26 Research Institute )  
Nanping Huayuan Road No. 14  
Chongqing, China, 400060

Part Number	LBN07091	
Rev. Date	2005-3-9	
Rev.	1.0	Page 3/3