

N1500 and N2000 SERIES

Single, and dual output

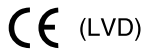

[2 YEAR WARRANTY]



- Active harmonic correction to EN61000-3-2
- 180VAC to 264VAC input voltage range
- Flexible output voltage configuration
- Two output power ratings
- Forced current sharing, all outputs
- DC OK (including LED)
- UL, CSA and TÜV safety approvals
- Industry standard 5 x 8 x 11 inch footprint

The N1500 and N2000 series are a range of system-orientated, single or dual output power supplies with output powers of 1500W and 2000W. Harmonically corrected, they operate from 180VAC to 264VAC. World wide safety approvals are standard. Fan cooled and enclosed in the industry standard 5 x 8 x 11 inch form, the N1500 and N2000 series are an ideal choice when the economy and predictable performance of a centralized system power supply are desired. By utilizing dual high current converters, operating independently or together, a wide variety of output voltage and current combinations can be factory configured. The N1500 and N2000 extend the range of the N1000 family. Forced current share provides higher current to satisfy needs in large systems, or to power expansion chassis. Dual output models at 5VDC/12VDC are perfect to power mass storage systems. Other applications might use 5VDC/3.3VDC, both operating at high currents. Single output versions, operating alone or in redundant mode provide an economic power source for distributed systems. System interface signals include AC and DC good, current monitor (V1). OVP, OCP, overtemperature protection, remote enable, margin check inhibit as standard. By combining robust performance and broad range, the N1500 and N2000 series sets the standard for centralized system power supplies.

SPECIFICATION All specifications are typical at nominal input, full load at 25°C unless otherwise stated

OUTPUT SPECIFICATIONS (2)		
Voltage adjustability	Accessible at front panel	±10%
Remote sense	Open/reverse sense lead protection Compensates for voltage drop of up to 0.5V to the load	
Regulation, line or load	All outputs, NL-FL at nominal line or all line variations at FL	±0.2%; 10mV min.
Cross regulation	0.2% max. or 10mV between outputs	
Overshoot/undershoot	None at turn-on/off	
Transient response	Main output 25% step load change at 1A/μs	≤2.0% max. dev., ≤200μs recovery to 1.0%
Temperature coefficient	±0.02%/°C	
Ripple and noise	0Hz to 20MHz	50mV pk-pk or 1.0%
Overvoltage protection	Reset by cycling AC	115 to 130% of nominal
Overload protection	105-115% full load	
Short circuit protection	All outputs	Auto recovery
Thermal protection	Auto shutdown, AC reset	
Current sharing	±5.0%	50% to 100% load
Current monitor (V1)	5VDC at full load	±0.5V
INPUT SPECIFICATIONS		
Input voltage range	180 to 264VAC	
Input frequency range	47Hz to 63Hz	
Input surge current	Meets IEEE std. 587.1980; 3KV ring wave	
Input current	230VAC, 2000W	13A
Power factor	230VAC, 2kW load	0.98 min.
Power up time	Full load	1.0s max.

EMC CHARACTERISTICS		
Radiated emissions	EN55022/11, FCC part 15	Level A
Conducted emissions	EN55022/11, FCC part 15	Level A
Harmonic distortion	EN61000-3-2	Conforms
Electrostatic discharge	EN61000-4-2	Level 3
RF field susceptibility	EN61000-4-3	Level 3
Electrical fast transients/bursts	EN61000-4-4	Level 3
Surge susceptibility	EN61000-4-5	Level 3
GENERAL SPECIFICATIONS		
Hold-up time	180VAC, 2kW load	15ms min.
Efficiency	230VAC, full load	73%
Isolation voltage	Input/output Input/chassis Output/output	3000VAC 1500VAC 500VAC
Switching frequency	100kHz	
Approvals and standards	EN60950, UL1950, CSA C22.2 No. 950	
Weight	6.9kg (15lbs)	
Size	5 x 8 x 11 inches 127 x 203.2 x 279.4 mm	
MTBF	per MIL-HDBK-217E	100,000 hours
ENVIRONMENTAL SPECIFICATIONS		
Thermal performance	Operating ambient Non-operating	0°C to +50°C -15°C to +85°C
Cooling	60CFM	Internal DC ball bearing fan
Relative humidity	Non-condensing	0% to 95% RH
Altitude	Operating Non-operating	6,000 feet max. 55,000 feet max.
Vibration	5Hz to 500Hz	2.4G rms peak

1500 and 2000 Watt AC/DC high wattage power supplies with PFC

MAX. OUTPUT POWER ⁽¹⁾	OUTPUT V1 VOLTAGE/CURRENT	OUTPUT V2 VOLTAGE/CURRENT	MODEL NUMBER
1500W	3.3V @ 300A		N1500-96-9
1500W	5.0V @ 300A		N1500-96-1
1500W	12V @ 125A		N1500-96-2
1500W	24V @ 62A		N1500-96-4
1500W	28V @ 54A		N1500-96-5
1500W	48V @ 31A		N1500-96-6
1500W	5.0V @ 200A	12V @ 50A	N1500-96-12
1500W	5.0V @ 200A	24V @ 24A	N1500-96-14
2000W	5.0V @ 360A		N2000-96-1
2000W	12V @ 150A		N2000-96-2
2000W	24V @ 83A		N2000-96-4
2000W	28V @ 71A		N2000-96-5
2000W	48V @ 42A		N2000-96-6
2000W	5.0V @ 240A	12V @ 66A	N2000-96-12
2000W	5.0V @ 240A	24V @ 33A	N2000-96-14
2000W	5.0V @ 240A	3.3V @ 120A	N2000-96-19

International Safety Standard Approvals

TÜV VDE0805/EN60950/IEC950 File No. R917062
Certificate No. R9172062

UL UL1950 File No. E135734

CSA CSA C22.2 No. 950 Bulletin No. 1402C

1500 and 2000 Watt AC/DC high wattage power supplies with PFC

OUTPUT PIN CONNECTIONS		
PIN NO.	J1	J2
1	+ Sense (V1) ⁽⁴⁾	+ Sense (V2)
2	Current Monitor (V1) ⁽⁵⁾	- Sense (V2)
3	Inhibit ⁽⁵⁾	Current Share (V2)
4	- Sense (V1) ⁽⁴⁾	Inhibit ⁽⁵⁾
5	No Connection	N/A
6	No Connection	N/A
7	Current Share ⁽⁵⁾	N/A
8	Remote Adj. (V1) ⁽⁶⁾	N/A
9	AC Good ⁽⁵⁾	N/A
10	Chassis Ground	N/A
11	Logic Ground	N/A
12	Margin ⁽⁷⁾	N/A
13	No Connection	N/A
14	DC OK ^(5,8)	N/A

Mechanical notes

- A AC connector is 3 position terminal block (#8 screws included), mating to #8 ring tongue terminal.
- B DC output is 5/16-18 studs mating to 5/16 terminal lugs.
- C J-1 signal connector is Molex 39-30-1140 or equivalent. Mating connector is Molex 39-01-2140 or equivalent.
- D J-2 signal connector is Molex 39-01-1120 or equivalent. Mating connector is 39-01-2120 or equivalent.
- E Signal connector contacts are Molex 39-00-0039 or equivalent.
- F TB1 and J2 are not installed on single output models.
- G Alternate I/O configurations are available. Please consult factory for further details.

Notes

- 1 1500W or 2000W max. power. All outputs isolated.
- 2 Specifications refer to all outputs except as noted (V1).
- 3 Signal referenced to V1 output neg. sense trim.
- 4 Use 20AWG or larger twisted pair.
- 5 Reference to Logic Ground (Pin J1-J11).
- 6 See Figure 4.
- 7 See Figure 3.
- 8 See Figure 5.

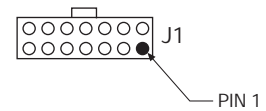
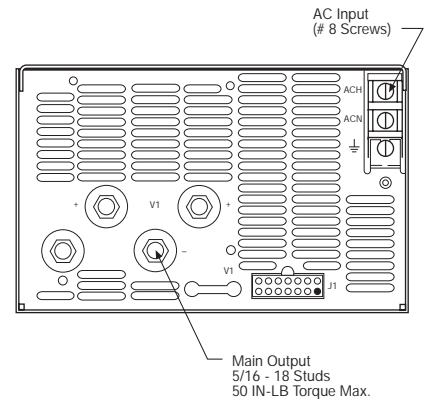
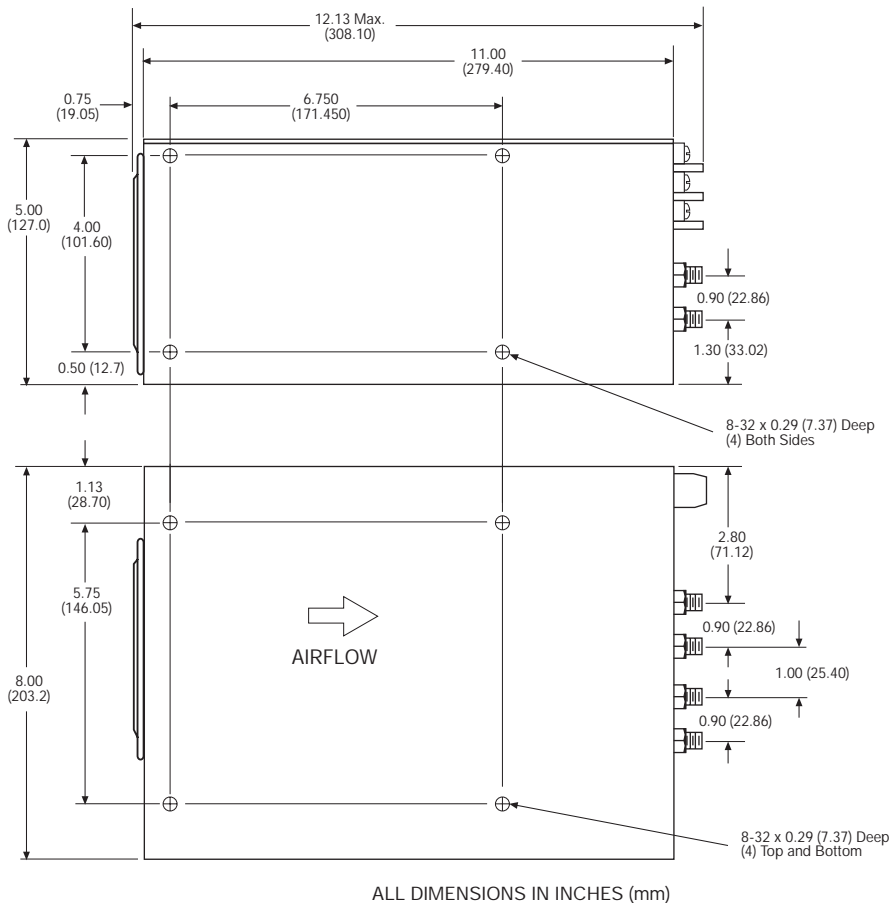

1500 and 2000 Watt AC/DC high wattage power supplies with PFC

FIG. 1

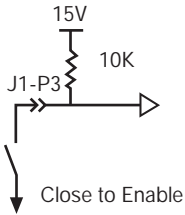

FIG. 2 (Ref. FIG 5)

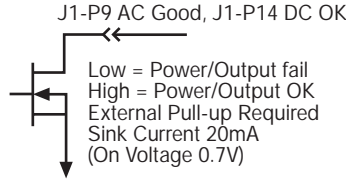

FIG. 5

AC Power Fail Signal/DC OK Timing

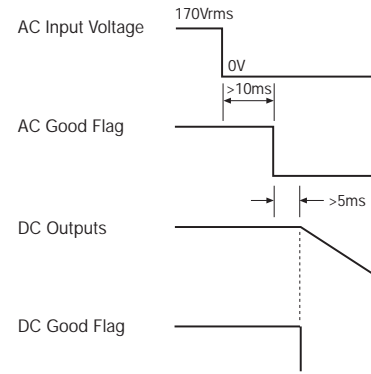

FIG. 3

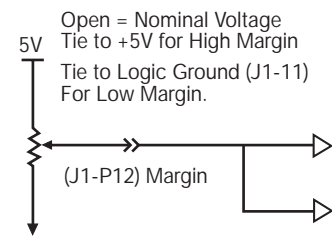
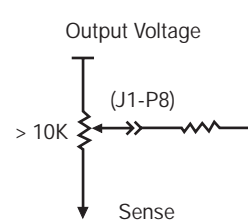

FIG. 4



STANDARD CONTROL SIGNALS	
Remote enable	See Figure 1
DC OK (See Figures 2 and 5)	Signal remains "Hi" as long as output is $\pm 5.0\%$ of nominal.
AC power fail signal (See Figure 5)	Signal "Hi" when AC $> 170\text{VAC}$ and "Lo" when $< 150\text{VAC}$.
Margin Hi/Lo (V1) (See Figure 3)	Allows $\pm 5.0\%$ change in output for system margin checking.
Remote Adjust (See Figure 4)	The outputs may be remotely adjusted linearly $\pm 10\%$.
Current Monitor	Analog signal indicates load current in single or parallel operation. $5 \pm 0.5\text{VDC}$ represents FL, resistive load $10^3\text{k}\Omega$.