

**Ultra Low Dropout, 3.0A
 Adjustable Positive Linear Regulator
 Thru-Hole (MO-078AA)**

**OM7764ASC
 5962 - 0323801MYA**

Product Summary

Part Number	Output Voltage	Current	Dropout
OM7764ASC	1.21V to 20V	3.0A	0.4V



Description

The OM7764ASC is a 3.0A, ultra low dropout, adjustable linear regulator specifically designed for low voltage, high current applications. Housed in a hermetic package, the dropout of these devices is 400mV at full load. All protective features are designed into the circuit including thermal shutdown, current limiting and safe area control. These units are ideally suited for military/defense, commercial aircraft, industrial control and other harsh environments where a hermetically sealed package is required.

Features:

- Dropout Voltage of 400mV at Full Load
- Wide Input Range: 2.7V to 20V
- Low Noise: 40mVRMS (10Hz to 10KHz)
- Fast Transient Response
- No Protection Diodes needed
- Hermetic MO-078AA Package ensures High Reliability

Absolute Maximum Ratings

Parameter	Symbol	Value	Units
Output Current	I_O	3.0	A
Input Voltage	V_{IN}	+20	V
Power Dissipation @ $T_c = 25^\circ\text{C}$	P_D	20	W
Thermal Resistance, Junction to Case	$R_{\theta JC}$	5.0	$^\circ\text{C}/\text{W}$
Operating Junction Temperature Range	T_J	-55 to +125	$^\circ\text{C}$
Storage Temperature Range	T_{STG}	-65 to +150	
Lead Temperature Soldering (10second maximum)	T_L	300	

Electrical Characteristics @T_A = 25°C (Unless Otherwise Specified)

Parameter	Test Conditions	Min.	Typ.	Max.	Units
Minimum Input voltage	I _{LOAD} = 3.0A ①	-	2.3	2.7	V
Line Regulation	ΔV _{IN} = 2.21V to 20V, I _{LOAD} = 1.0mA ①②	-	2.0	10	mV
Load Regulation	V _{IN} = 2.7V, I _{LOAD} = 1.0mA to 3.0A	-	5.0	10	
	V _{IN} = 2.7V, I _{LOAD} = 1.0mA to 3.0A ①②	-	-	50	
Adjust Pin Voltage	V _{IN} = 2.21V, I _{LOAD} = 1.0mA	1.192	1.210	1.228	V
	2.7V < V _{IN} < 20V, 1.0mA < I _{LOAD} < 3.0A ①	1.168	1.210	1.246	
Dropout Voltage	I _{LOAD} = 1.0mA	-	0.02	0.05	
	I _{LOAD} = 1.0mA ①	-	-	0.10	
	I _{LOAD} = 100mA	-	0.07	0.13	
	I _{LOAD} = 100mA ①	-	-	0.18	
	I _{LOAD} = 500mA	-	0.14	0.20	
	I _{LOAD} = 500mA ①	-	-	0.27	
	I _{LOAD} = 1.5mA	-	0.25	0.33	
	I _{LOAD} = 1.5mA ①	-	-	0.40	
	I _{LOAD} = 3.0A	-	0.4	0.54	
I _{LOAD} = 3.0A ①	-	-	0.66		
Ground Pin Current V _{IN} = V _{OUT} (Nominal)+1	I _{LOAD} = 0mA ①	-	1.0	1.5	mA
	I _{LOAD} = 1.0mA ①	-	1.1	1.6	
	I _{LOAD} = 100mA ①	-	3.5	5.0	
	I _{LOAD} = 500mA ①	-	11	18	
	I _{LOAD} = 1.5A ①	-	40	75	
	I _{LOAD} = 3.0A ①	-	120	200	
Ripple Rejection	V _{IN} - V _{OUT} = 1.5V(Average), V _{RIPPLE} = 0.5 V _{P-P} f _{RIPPLE} = 120Hz, I _{LOAD} = 1.5A, T _J = +25°C	55	65	-	dB
Current Limit	V _{IN} = 2.7V, ΔV _{OUT} = -0.1V ①	3.1	-	-	A
Input Reverse Leakage Current	V _{IN} = -20V, V _{OUT} = 0V ①	-	-	1.0	mA
Reverse Output Current	V _{OUT} = 1.21V, V _{IN} < 1.21V ①	-	300	600	μA

Footnotes

- ①- Denotes specifications which apply over the full operating temperature range.
 ②- The OM7764ASC is tested and specified for these conditions with the ADJ pin connected to the OUT pin.

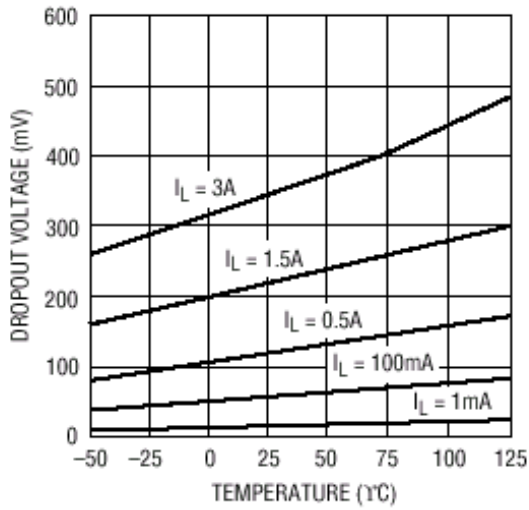

Fig 1: Dropout Voltage Vs Temperature

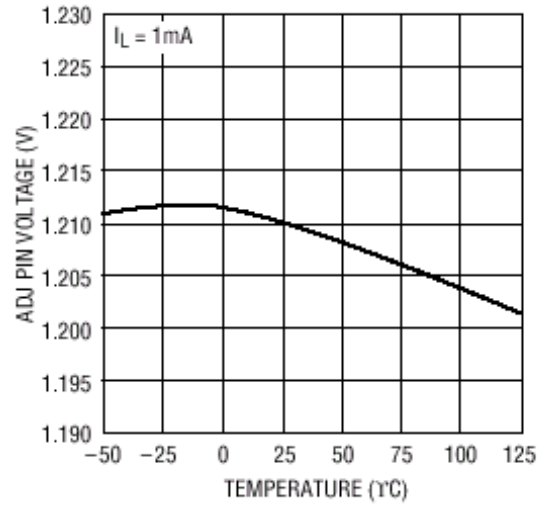

Fig 2: Adjust Pin Voltage Vs Temperature

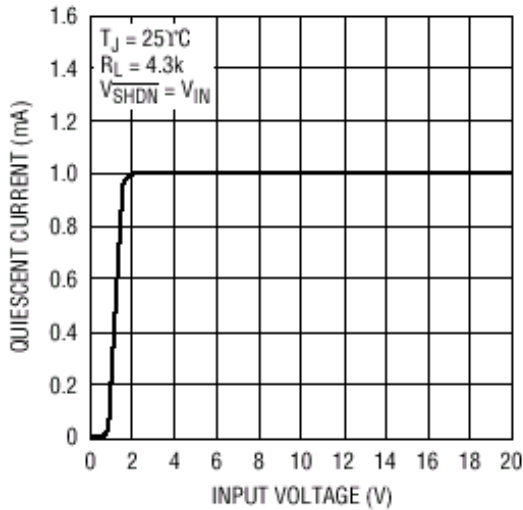

Fig 3: Quiescent Current Vs Input Voltage

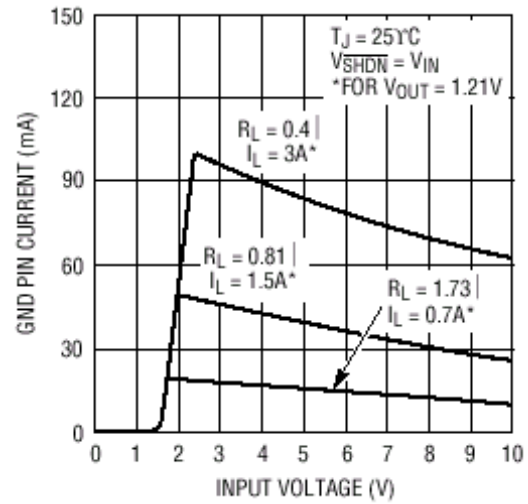

Fig 4: Ground Pin Current Vs Input Voltage

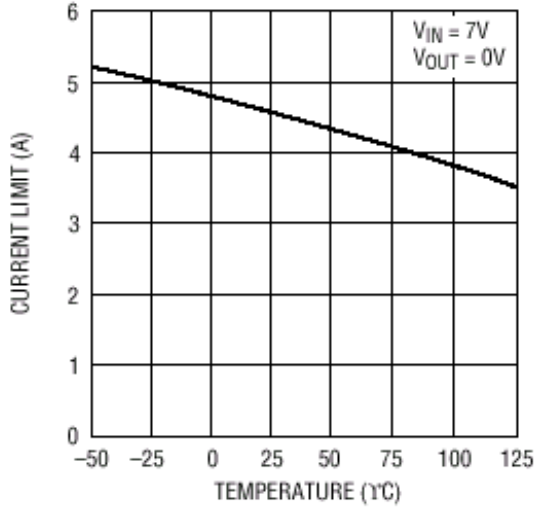
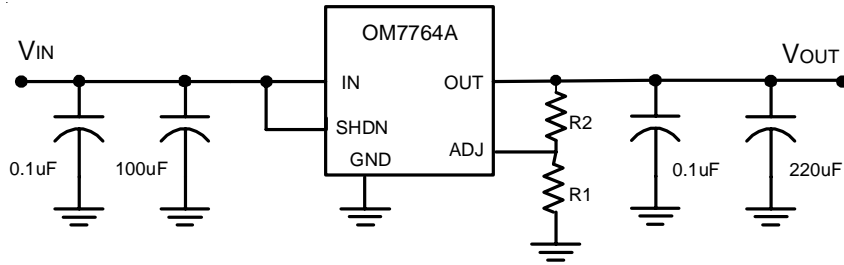

Fig 5: Current Limit Vs Temperature



$$V_{OUT} = 1.21V(1 + (R2/R1)) + I_{ADJ}(R2)$$

$$I_{ADJ} = 3.0\mu A @ 25^{\circ}C$$

Fig 6: Typical Application

Layout Consideration

It is recommended that output capacitors be located as close as possible to the V_{OUT} terminal of the device to prevent any high frequency oscillation that may result due to excessive stray inductance. Specifications for capacitors: 220µF (+25V) Tantalum, 100µF (+25V) Tantalum, 0.1µF (+50V) Ceramic

Case Outline and Dimensions — MO-078AA

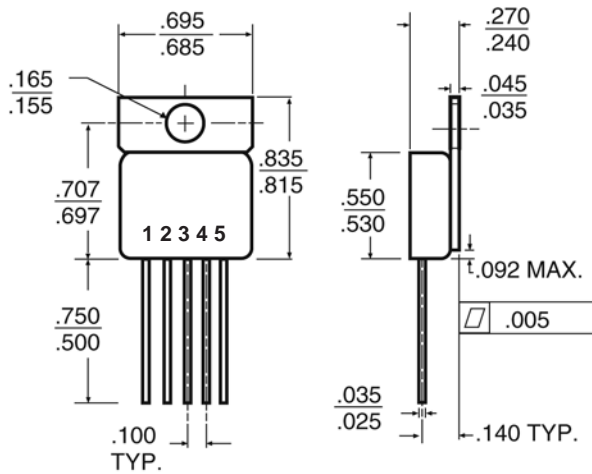

Pin Assignment

Pin #	Pin Description
1	SHUTDOWN
2	INPUT
3	GROUND
4	OUTPUT
5	ADJUST

Part Numbering Nomenclature

OM	7764A	S	C	X
Omnirel	Device	S=Isolated	Package	Screening