

TMC-5F31-xxx

High speed VCSEL TO-46 metal can

FEATURES:

- Industry standard TO-46 package with flat window glass.
- Optimized for fiber optical communication with a monitor PD.
- Low dependence of electrical and optical characteristic over temperature.
- Symmetrical beam.
- High coupling efficiency to multi-mode fibers.
- Speed > 1 GHz.

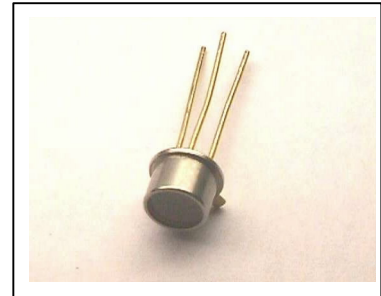

ELECTRO-OPTICAL CHARACTERISTICS:

| PARAMETERS | SYMBOL | MIN | TYP | MAX | UNIT | TEST CONDITIONS ⁽¹⁾ |
|-------------------|-------------|-----|------|-----|---------------|---|
| Threshold Current | I_{th} | | 3 | 6 | mA | |
| Output Power | P_o | 1 | 2 | 3 | mW | $I_F=12\text{ mA}$ ⁽²⁾ |
| Operating Current | I_{OP} | | 12 | | mA | Adjustable to establish 1.5 mW output power |
| Slope Efficiency | η | | 0.25 | | mW/mA | $I_F=12\text{ mA}$ ⁽³⁾ |
| Wavelength | λ_p | 830 | 850 | 860 | nm | $I_F=12\text{ mA}$ |
| Forward Voltage | V_F | 1.7 | 1.9 | 2.3 | V | $I_F=12\text{ mA}$ |
| Breakdown voltage | V_{BD} | 10 | 15 | | V | $I_R=10\text{ }\mu\text{A}$ |
| Series Resistance | R_S | | 40 | | Ω | $I_F=12\text{ mA}$ |
| Monitor Current | I_M | 1 | 2 | | μA | $V_R=5\text{ V}$, $P_o=1.5\text{ mW}$ |
| Beam Divergence | θ | | 8 | | degree | $I_F=12\text{ mA}$ ⁽⁴⁾ |

Notes:

1. All parameters except mentioned are measured at $I_F=12\text{ mA}$, 25°C , CW.
2. Higher power can be provided under request.
3. Slope efficiency is defined as $\Delta P/(12-I_{th})$ at 25°C .
4. Beam divergence is defined as the angle of light intensity at Full Width at Half Maximum (FWHM).

THERMAL CHARACTERISTICS:

| PARAMETERS | SYMBOL | MIN | TYP | MAX | UNIT | TEST CONDITIONS |
|-------------------------------------|----------------------------|-----|-------|------|---------------------------|---|
| Thermal Resistance | R_{th} | | 900 | | $^\circ\text{C}/\text{W}$ | $T_A=25^\circ\text{C}$ |
| I_{th} Temperature Variation | ΔI_{th} | -1 | | 1 | mA | $T_A=0\sim 70^\circ\text{C}$ |
| V_F Temperature Coefficient | $\Delta V_F/\Delta T$ | | -2.5 | -3.5 | mV/ $^\circ\text{C}$ | $T_A=0\sim 70^\circ\text{C}$, $I_F=12\text{ mA}$ |
| Temperature Coefficient | $\Delta\eta/\Delta T$ | | -0.15 | | %/ $^\circ\text{C}$ | $T_A=0\sim 70^\circ\text{C}$, $I_F=12\text{ mA}$ |
| λ_p Temperature Coefficient | $\Delta\lambda_p/\Delta T$ | | 0.06 | | nm/ $^\circ\text{C}$ | $T_A=0\sim 70^\circ\text{C}$, $I_F=12\text{ mA}$ |

ABSOLUTE MAXIMUM RATINGS:

| PARAMETERS | MIN | MAX | UNIT | CONDITIONS |
|----------------------------|-----|-----|------|------------|
| Storage Temperature | -40 | 125 | | |
| Operating Temperature | -20 | 85 | | |
| Lead Solder Temperature | | 260 | | 5 seconds |
| Continuous Forward Current | | 40 | mA | |
| Continuous Reverse Voltage | | 10 | V | |

Fig. 1 Typical Optical Characteristics

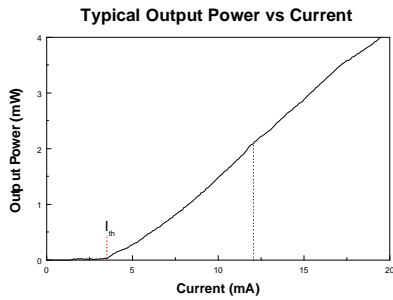

Fig. 2 Typical Electrical Characteristics

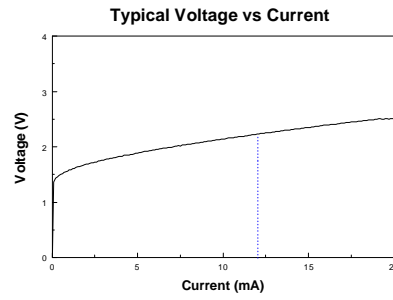
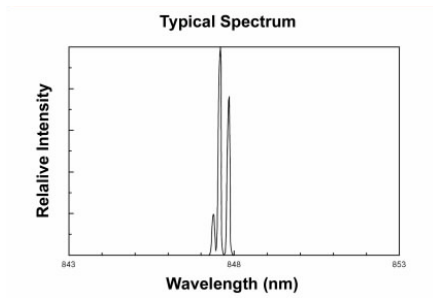
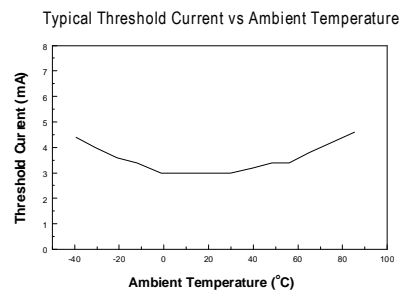

Fig. 3 Spectrum When Driving Current 15 mA



3 transverse modes typically.

Fig. 4 Temperature Dependence of Threshold Current



WARNING:

The VCSEL is a class IIIb laser in the safety standard ANSI Z136.1 and should be treated as a potential eye hazard.

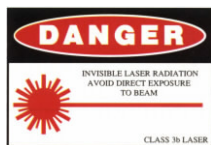

OUTLINE DIMENSIONS:

• Unit: mm

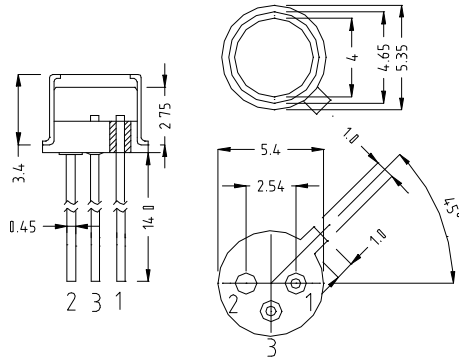

• PINOUT:

TMC-5F31-801

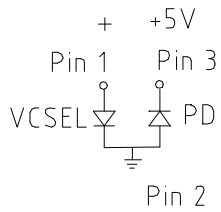

Pin 1: VCSEL Anode

Pin 2: VCSEL Cathode
PD Anode
Case

Pin 3: PD Cathode

TMC-5F31-802

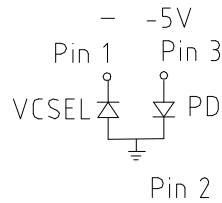

Pin 1: VCSEL Cathode

Pin 2: VCSEL Anode
PD Cathode
Case

Pin 3: PD Anode

TMC-5F31-803

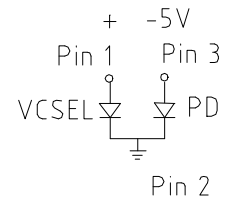

Pin 1: VCSEL Anode

Pin 2: VCSEL Cathode
PD Cathode
Case

Pin 3: PD Anode