



P-Channel Enhancement Mode MOSFET

PRODUCT SUMMARY		
V _{DS}	I _D	R _{DS(ON)} (mΩ) MAX
-20V	-5.4A	45 @ V _{GS} = -4.5V
		70 @ V _{GS} = -2.7V

FEATURES

- Super high dense cell design for low R_{DS(ON)}.
- Rugged and reliable.
- Surface Mount Package.

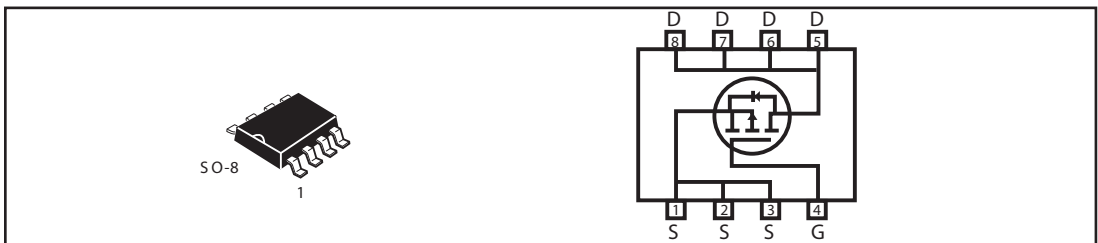

ABSOLUTE MAXIMUM RATINGS (T_A=25 °C unless otherwise noted)

Parameter	Symbol	Limit	Unit
Drain-Source Voltage	V _{DS}	-20	V
Gate-Source Voltage	V _{GS}	±12	V
Drain Current-Continuous ^a @ T _J =125 °C -Pulsed ^b	I _D	±5.4	A
	I _{DM}	±20	A
Drain-Source Diode Forward Current ^a	I _S	2.6	A
Maximum Power Dissipation ^a	P _D	2.5	W
Operating Junction and Storage Temperature Range	T _J , T _{STG}	-55 to 150	°C

THERMAL CHARACTERISTICS

Thermal Resistance, Junction-to-Ambient ^a	R θ _{JA}	50	°C/W
--	-------------------	----	------

SDM9433

ELECTRICAL CHARACTERISTICS (T_A = 25°C unless otherwise noted)

Parameter	Symbol	Condition	Min	Typ ^c	Max	Unit
OFF CHARACTERISTICS						
Drain-Source Breakdown Voltage	BV _{DSS}	V _{GS} = 0V, I _D = -250μA	-20			V
Zero Gate Voltage Drain Current	I _{DSS}	V _{DS} = -16V, V _{GS} = 0V			-1	μA
Gate-Body Leakage	I _{GSS}	V _{GS} = ±12V, V _{DS} = 0V			±100	nA
ON CHARACTERISTICS^b						
Gate Threshold Voltage	V _{GS(th)}	V _{DS} = V _{GS} , I _D = -250μA	-0.7			V
Drain-Source On-State Resistance	R _{DS(ON)}	V _{GS} = -4.5V, I _D = -5.1A			45	m-ohm
		V _{GS} = -2.7V, I _D = -2.0A			70	m-ohm
On-State Drain Current	I _{D(ON)}	V _{DS} = -5V, V _{GS} = -4.5V	-20			A
Forward Transconductance	g _{FS}	V _{DS} = -15V, I _D = -5.3A		13		S
DYNAMIC CHARACTERISTICS^c						
Input Capacitance	C _{ISS}	V _{DS} = -10V, V _{GS} = 0V f = 1.0MHz		1190		pF
Output Capacitance	C _{OSS}			710		pF
Reverse Transfer Capacitance	C _{RSS}			260		pF
SWITCHING CHARACTERISTICS^c						
Turn-On Delay Time	t _{D(ON)}	V _D = -10V, I _D = -1A, V _{GEN} = -4.5V, R _{GEN} = 6 -ohm		20	40	ns
Rise Time	t _r			18	70	ns
Turn-Off Delay Time	t _{D(OFF)}			50	120	ns
Fall Time	t _f			29	140	ns
Total Gate Charge	Q _g	V _{DS} = -10V, I _D = -1A, V _{GS} = -4.5V		20	25	nC
Gate-Source Charge	Q _{gs}			4		nC
Gate-Drain Charge	Q _{gd}			4.3		nC

S DM9433

ELECTRICAL CHARACTERISTICS ($T_A=25^{\circ}\text{C}$ unless otherwise noted)

Parameter	Symbol	Condition	Min	Typ ^c	Max	Unit
DRAIN-SOURCE DIODE CHARACTERISTICS^b						
Diode Forward Voltage	V_{SD}	$V_{GS} = 0\text{V}, I_s = -5.3\text{A}$		-0.89	-1.2	V

Notes

- a. Surface Mounted on FR4 Board, $t \leq 10\text{sec}$.
- b. Pulse Test: Pulse Width $\leq 300\mu\text{s}$, Duty Cycle $\leq 2\%$.
- c. Guaranteed by design, not subject to production testing.

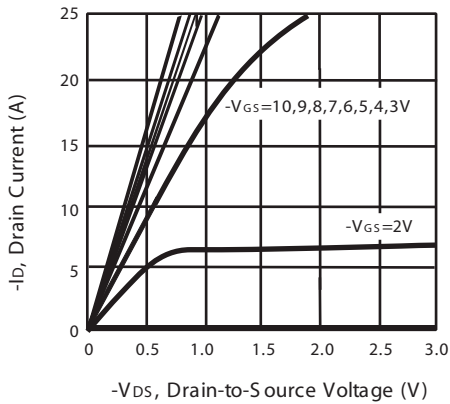

Figure 1. Output Characteristics

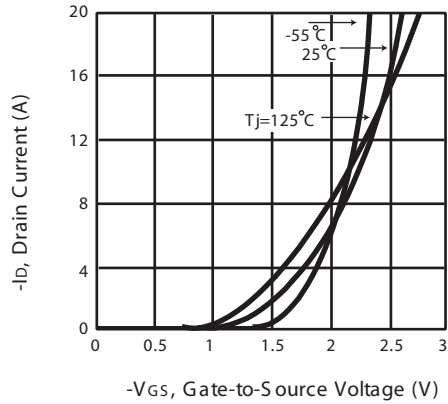

Figure 2. Transfer Characteristics

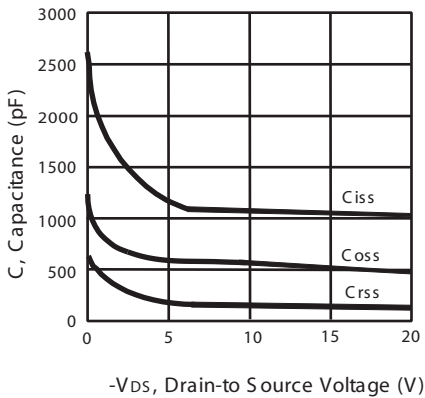

Figure 3. Capacitance

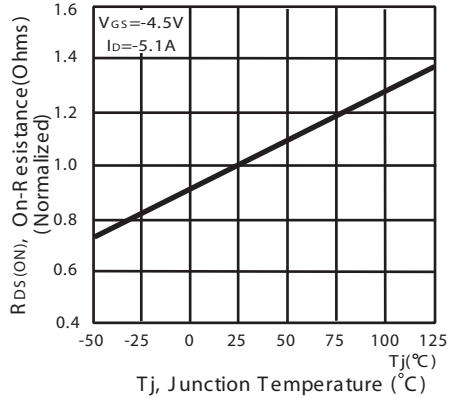
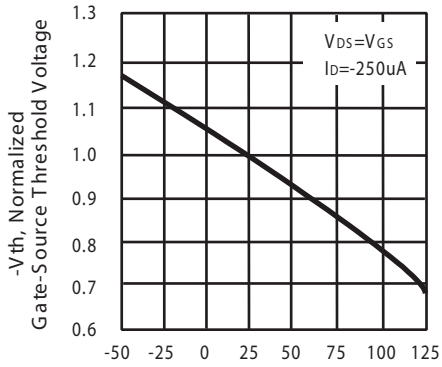

Figure 4. On-Resistance Variation with Temperature

S DM9433



Tj, Junction Temperature (°C)

Figure 5. Gate Threshold Variation with Temperature

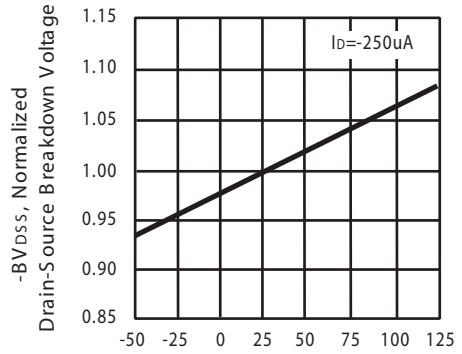

Tj, Junction Temperature (°C)

Figure 6. Breakdown Voltage Variation with Temperature

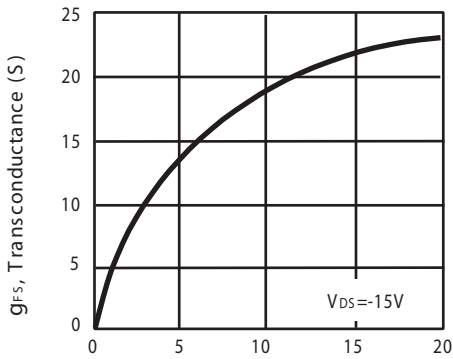

-ID, Drain-Source Current (A)

Figure 7. Transconductance Variation with Drain Current

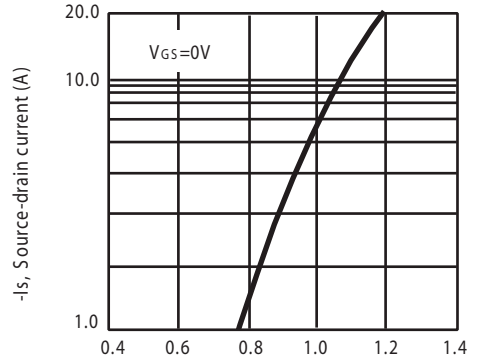

-VSD, Body Diode Forward Voltage (V)

Figure 8. Body Diode Forward Voltage Variation with Source Current

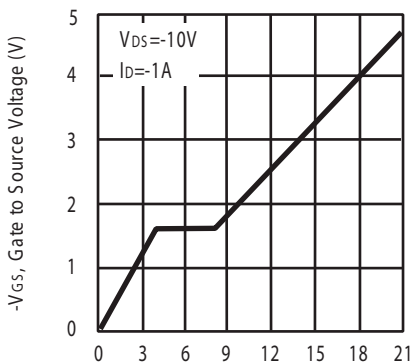

Qg, Total Gate Charge (nC)

Figure 9. Gate Charge

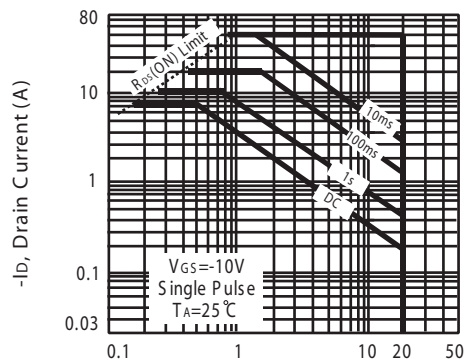

-VDS, Drain-Source Voltage (V)

Figure 10. Maximum Safe Operating Area

S DM9433

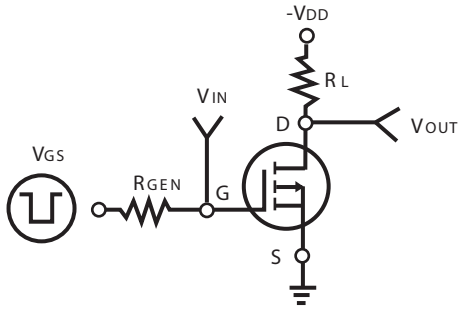

Figure 11. S switching Test Circuit

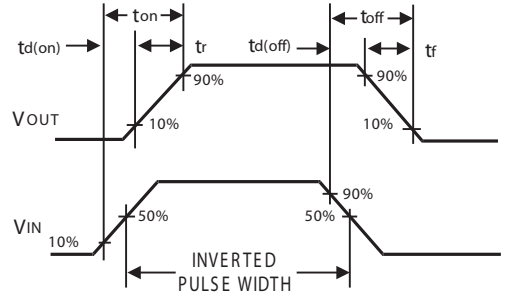

Figure 12. S switching Waveforms

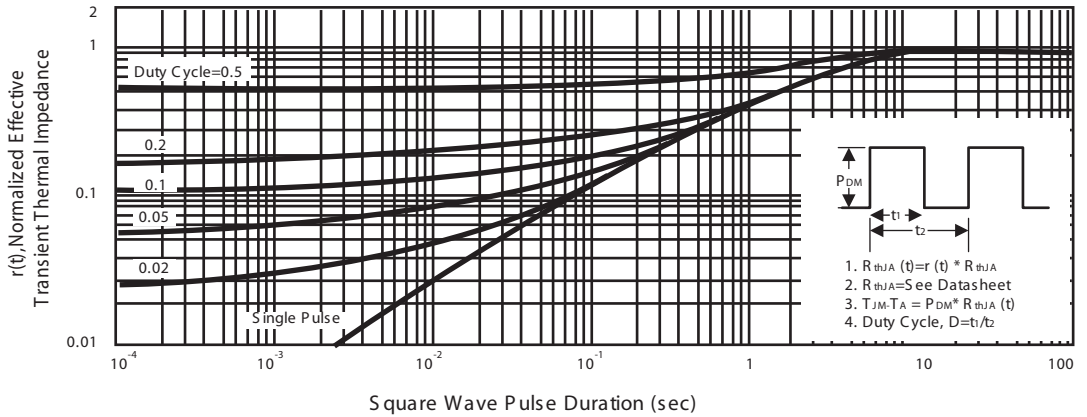

Figure 13. Normalized Thermal Transient Impedance Curve