

NOTES:

1.0 PINS WITHOUT ELECTRICAL CONNECTION ARE OMITTED.

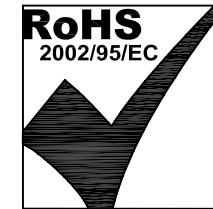

ELECTRICAL SPECIFICATIONS:

1.0 TURNS RATIO: (P3-P2) : (J2-J1) : 1CT : 1CT ±3%  
 (P5-P4) : (J6-J3) : 1CT : 1CT ±3%  
 (P7-P6) : (J5-J4) : 1CT : 1CT ±3%  
 (P9-P8) : (J8-J7) : 1CT : 1CT ±3%

2.0 INDUCTANCE: (P3-P2) ; (P5-P4) : 350 uH MIN. @ 0.01V, 100KHz, 8 mA DC BIAS  
 (P7-P6) ; (P9-P8) : 350 uH MIN. @ 0.01V, 100KHz, 8 mA DC BIAS

3.0 LEAKAGE INDUCTANCE: P3-P2 (WITH J2 AND J1 SHORT) : 0.3uH MAX. @ 1MHz  
 P5-P4 (WITH J6 AND J3 SHORT) : 0.3uH MAX. @ 1MHz  
 P7-P6 (WITH J5 AND J4 SHORT) : 0.3uH MAX. @ 1MHz  
 P9-P8 (WITH J8 AND J7 SHORT) : 0.3uH MAX. @ 1MHz

4.0 INTERWINDING CAPACITANCE: (P3-P2) : (J2-J1) : 85pf MAX @ 1MHz  
 (P5-P4) : (J6-J3) : 85pf MAX @ 1MHz  
 (P7-P6) : (J5-J4) : 85pf MAX @ 1MHz  
 (P9-P8) : (J8-J7) : 85pf MAX @ 1MHz

5.0 DC RESISTANCE: (J6-J3) ; (J2-J1) ; 1 : 1.2 ohms Max.

Bel Stewart Connector  
 1118 Susquehanna Trail, South  
 Glen Rock, Pa 17327-9199  
 717.234.7512

**MagJack®**  
<http://www.stewartconnector.com>

THIS DRAWING AND THE SUBJECT MATTER SHOWN THEREON ARE CONFIDENTIAL AND PROPERTY OF BEL STEWART CONNECTOR AND SHALL NOT BE REPRODUCED, COPIED, OR USED IN ANY MANNER WITHOUT PRIOR WRITTEN CONTENT OF BEL STEWART CONNECTOR. THE SUBJECT MATTER MAY BE PATENTED OR A PATENT MAY BE PENDING.

SHEET	DRAWING NO.	REV.
1 OF 4	SI-6001-F	04

- 6.0 RETURN LOSS: 1MHz TO 30MHz : 18dB MIN.  
 30MHz TO 80MHz :  $12-20 \text{ LOG } \left( \frac{F}{80\text{MHz}} \right)$
- 7.0 DIELECTRIC WITHSTAND: (J1,J2) TO (P2,P3) ; (J5,J4) TO (P6-P5) : 1500 VAC  
 (J3,J6) TO (P7,P4) ; (J8,J7) TO (P9, P8) : 1500 VAC
- 8.0 INSERTION LOSS: RS=RL=100 ohms : 1.1 dB MAX  
 100KHz TO 100MHz
- 9.0 RISE TIME: RS=100 OHMS AND RL = 100 OHMS : 3.0 nS MAX  
 OUTPUT VOLTAGE = 1 V peak : 3.0 nS MAX  
 PULSE WIDTH= 112nS
- 10.0 CROSS TALK: 1-60 MHz : 35 dB MIN  
 60-100 MHz : 25 dB MIN
- 11.0 COMMON TO COMMON MODE ATTENUATION: 1MHz TO 100MHz : 35dB TYP

Bel Stewart Connector  
 1118 Susquehanna Trail, South  
 Glen Rock, Pa 17327-9199  
 717.234.7512

**MagJack®**

<http://www.stewartconnector.com>

THIS DRAWING AND THE SUBJECT MATTER SHOWN THEREON ARE CONFIDENTIAL AND PROPERTY OF BEL STEWART CONNECTOR AND SHALL NOT BE REPRODUCED, COPIED, OR USED IN ANY MANNER WITHOUT PRIOR WRITTEN CONTENT OF BEL STEWART CONNECTOR. THE SUBJECT MATTER MAY BE PATENTED OR A PATENT MAY BE PENDING.

SHEET

2 OF 4

DRAWING NO.

SI-61001-F

REV.

04

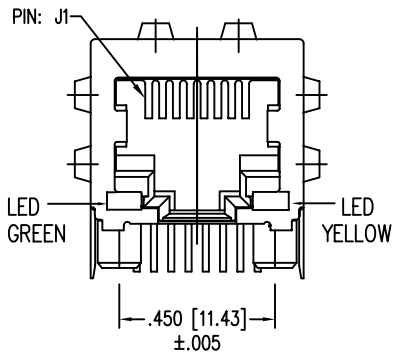
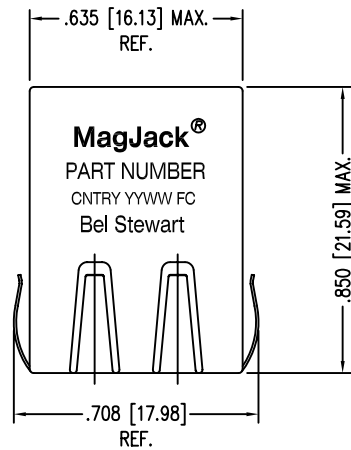

LED POLARITY  
(ENLARGED VIEW)

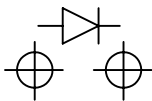

SINGLE COLOR LED

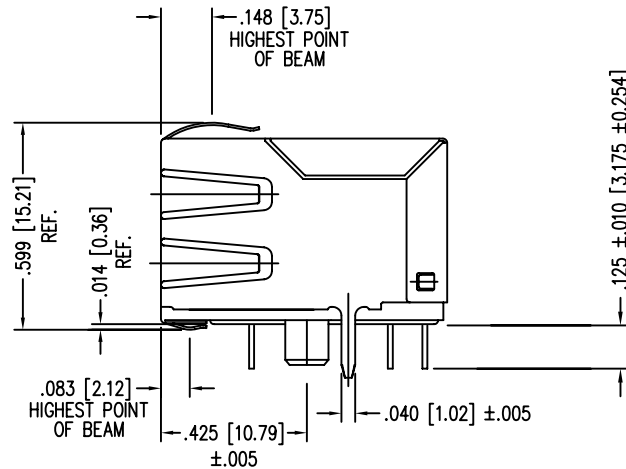

LED SPECIFICATION			
STANDARD LED	WAVELENGTH	FORWARD V (MAX)	* (TYP)
GREEN	565 nm	2.5 V	2.2 V
YELLOW	590 nm	2.5 V	2.1 V

\*WITH A FORWARD CURRENT OF 20 mA (TYP)

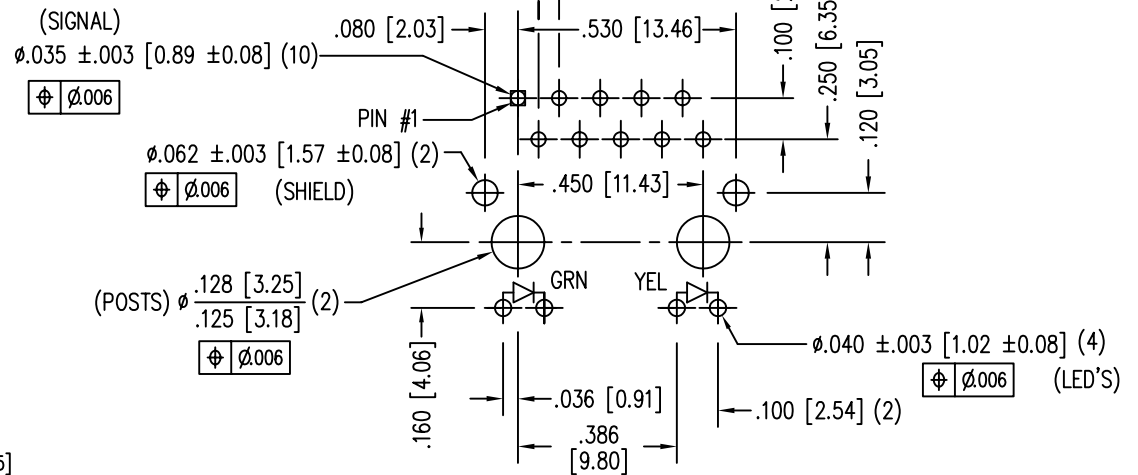

P.C.B. RECOMMENDED HOLE LAYOUT  
SEEN FROM COMPONENT SIDE

ALL CENTERLINE DIMENSIONS ARE BASIC.

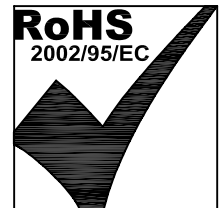

NOTES:

- CONNECTOR MATERIALS:  
HOUSING: THERMOPLASTIC UL94 V-0  
CONTACT/SHIELD: COPPER ALLOY  
SHIELD PLATING: NICKEL OR TIN  
CONTACT PLATING: SELECTIVE GOLD,  
50 MICRO-INCHES MIN. IN CONTACT AREA.
- PIN NOT ELECTRICALLY CONNECTED MAYBE OMITTED.  
SEE ELECTRICAL DRAWING FOR OMITTED PINS.
- TOLERANCES COMPLY WITH F.C.C. DIMENSION REQUIREMENTS.
- ALL TOLERANCES NOT OTHERWISE SPECIFIED TO BE ±.005 [0.13]
- REFLOW AND WAVE SOLDER COMPATIBLE-260°C FOR  
10 SECONDS MAX.

Bel Stewart Connector  
11118 Susquehanna Trail, South  
Glen Rock, Pa 17327-9199  
717.234.7512

**MagJack®**

<http://www.stewartconnector.com>

THIS DRAWING AND THE SUBJECT MATTER SHOWN THEREON ARE CONFIDENTIAL AND PROPERTY OF BEL STEWART CONNECTOR AND SHALL NOT BE REPRODUCED, COPIED, OR USED IN ANY MANNER WITHOUT PRIOR WRITTEN CONTENT OF BEL STEWART CONNECTOR. THE SUBJECT MATTER MAY BE PATENTED OR A PATENT MAY BE PENDING.

SHEET  
3 OF 4

DRAWING NO.  
SI-61001-F

REV.  
03

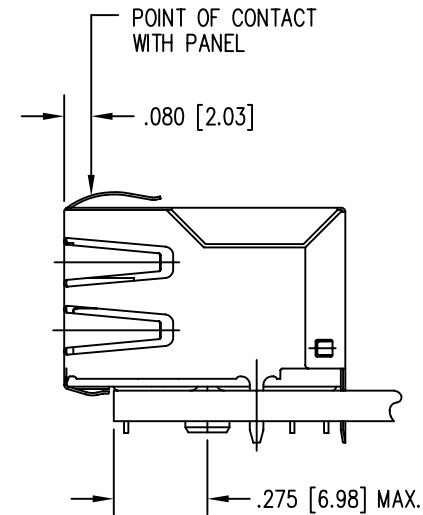
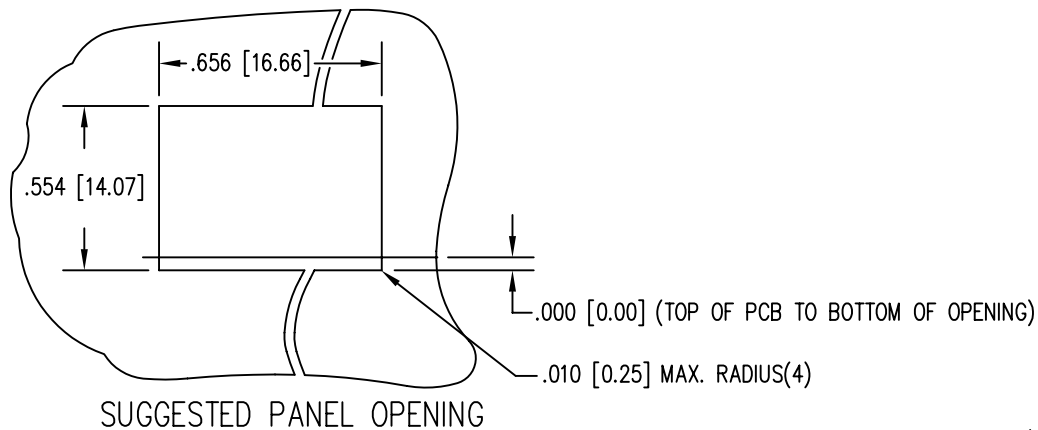

1. THE SUGGESTED PANEL OPENING IS INTENDED TO GIVE THE USER THE ABILITY TO HAVE REASONABLE JACK / PANEL CLEARANCES YET MAINTAIN RELIABLE GROUNDING CAPABILITY.
2. ALL TOLERANCES NOT OTHERWISE SPECIFIED TO BE  $\pm 0.005$  [0.13]

Bel Stewart Connector  
 11118 Susquehanna Trail, South  
 Glen Rock, Pa 17327-9199  
 717.234.7512

**MagJack®**

<http://www.stewartconnector.com>

THIS DRAWING AND THE SUBJECT MATTER SHOWN THEREON ARE CONFIDENTIAL AND PROPERTY OF BEL STEWART CONNECTOR AND SHALL NOT BE REPRODUCED, COPIED, OR USED IN ANY MANNER WITHOUT PRIOR WRITTEN CONTENT OF BEL STEWART CONNECTOR. THE SUBJECT MATTER MAY BE PATENTED OR A PATENT MAY BE PENDING.

SHEET 4 OF 4

DRAWING NO. SI-61001-F

REV. 03