

75 Ω VIDEO LINE DRIVER

FEATURES

- Internal Y-C Summing Circuit
- Voltage Gain is 6 dB Fixed
- Internal 75 Ω Driver
- Active High ON/OFF Control
- Very Low Standby Current (typ. $I_{STBY} \leq 25 \mu A$)
- Very Small Output Capacitor Using SAG Function Pin
- Very Small Package (SOT23L-8)
- Single +5 V Power Supply Operation

APPLICATIONS

- Video Equipment
- Digital Cameras
- CCD Cameras
- TV Monitors
- Video Tape Recorders
- LCD Projectors

DESCRIPTION

Operating from a single +5 V supply, the TK15409 is a video line driver IC that takes standard Y and C analog inputs and provides a composite analog output for driving 150 Ω loads (75 Ω resistor and 75 Ω cable load). Internal summing of the Y and C inputs is performed to produce the composite video output. The luminance (Y) input is clamped at 1.25 V and amplified 6 dB; the chrominance (C) input is biased at 2.0 V and amplified 6 dB. The internal 1.5 kΩ SAG function resistor provides gain compensation for low frequency signals. During standby (Pin 5 grounded), the TK15409 consumes only 127 μW of power. Nominal power dissipation (no input) is typically 90 mW.

The TK15409M is available in the very small SOT23L-8 surface mount package.

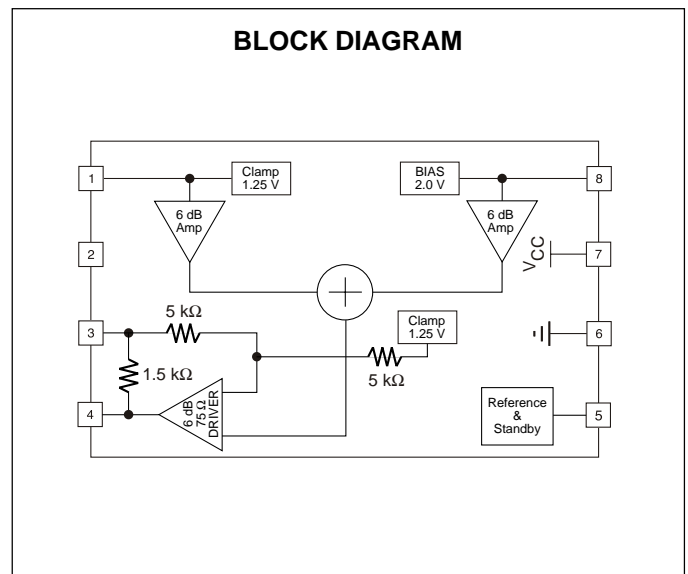
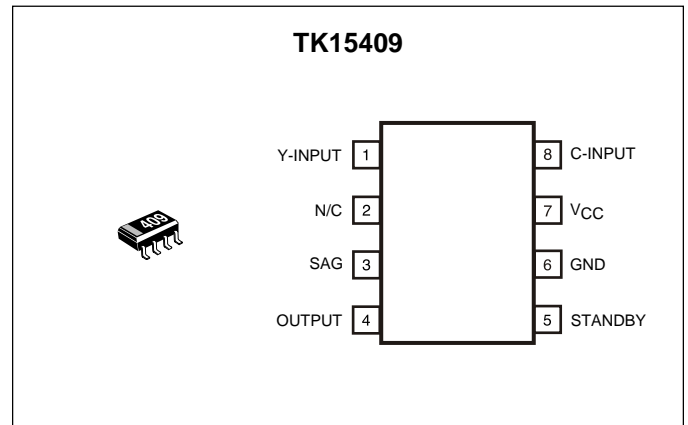

ORDERING INFORMATION

TK15409M

└──────────┘
Tape/Reel Code

TAPE/REEL CODE
TL: Tape Left

TK15409

ABSOLUTE MAXIMUM RATINGS

Supply Voltage 6 V Input Frequency 10.0 MHz
 Operating Voltage Range 4.5 to 5.5 V Storage Temperature Range -55 to +150 °C
 Power Dissipation (Note 1) 350 mW Operating Temperature Range -25 to +85 °C

TK15409M ELECTRICAL CHARACTERISTICS

Test conditions: $V_{CC} = 5.0\text{ V}$, $V_{IN} = 1.0\text{ V}_{P-P}$, $R_L = 150\ \Omega$, $T_A = 25\text{ °C}$ unless otherwise specified.

SYMBOL	PARAMETER	TEST CONDITIONS	MIN	TYP	MAX	UNITS
I_{CC}	Supply Current	No input		18.0	26.0	mA
I_{STBY}	Standby Supply Current	Pin 5 Grounded		25.3	50.0	μA
I_{OS}	Standby Terminal Current	Pin 5 in Standby mode		25.3	50.0	μA
V_{THL}	Threshold Voltage (High to Low)	Pin 5 Operating to Standby mode	GND		0.3	V
V_{TLH}	Threshold Voltage (Low to High)	Pin 5 Standby to Operating mode	1.8		V_{CC}	V
V_{CMP}	Clamp Voltage	Pin 1 Y signal input terminal	1.10	1.28	1.50	V
V_{BIAS}	Bias Voltage	Pin 8 C signal input terminal	1.70	2.00	2.30	V
GVA-Y1	Voltage Gain Y ch-1	$f_{IN} = 1\text{ MHz}$, Y signal input	5.2	5.7	6.2	dB
GVA-Y2	Voltage Gain Y ch-2	$f_{IN} = 15\text{ kHz}$, Y signal input	5.2	5.7	6.2	dB
GVA-C1	Voltage Gain C ch-1	$f_{IN} = 1\text{ MHz}$, C signal input	5.1	5.6	6.1	dB
GVA-C2	Voltage Gain C ch-1	$f_{IN} = 15\text{ kHz}$, C signal input	5.1	5.6	6.1	dB
DG	Differential Gain	Staircase signal input	-3.0	-1.2	+3.0	%
DP	Differential Phase	Staircase signal input	-3.0	-0.4	+3.0	deg
fr	Frequency Response	$f_{in} = 1\text{ MHz} / 5\text{ MHz}$		-0.5		dB

Note 1: Power dissipation is 350 mW in free air. Derate at 2.8 mW/°C for operation above 25°C.

TEST CIRCUIT

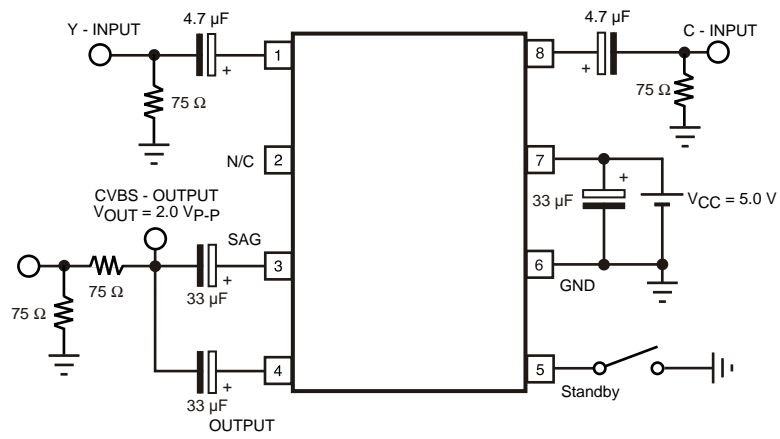

TYPICAL PERFORMANCE CHARACTERISTICS

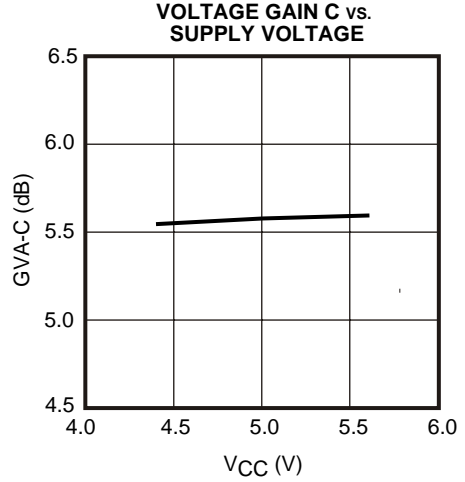
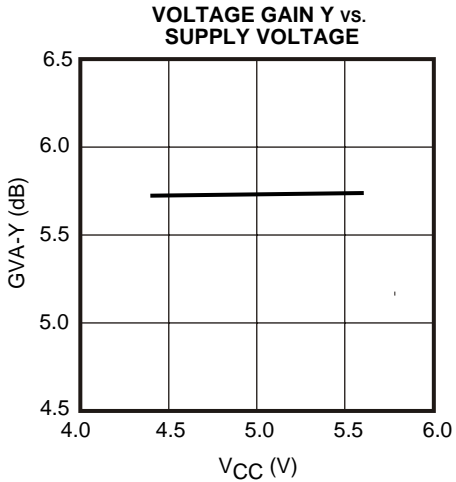
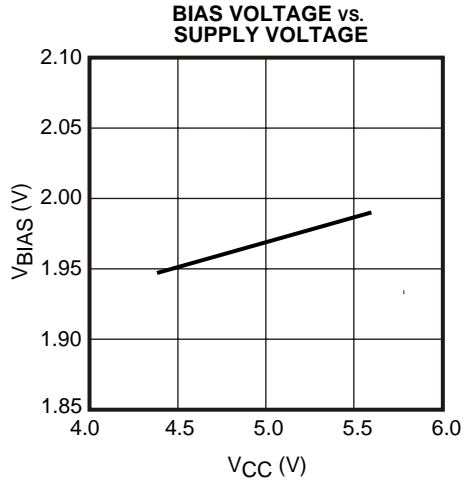
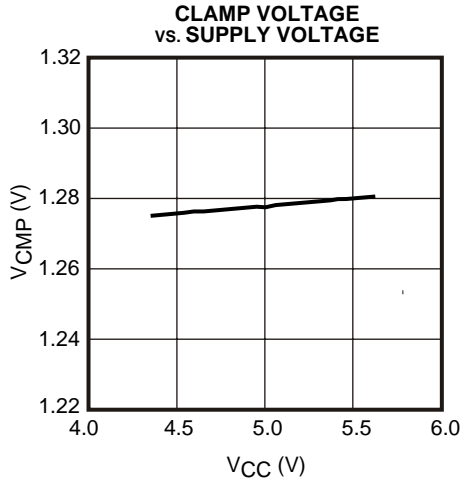
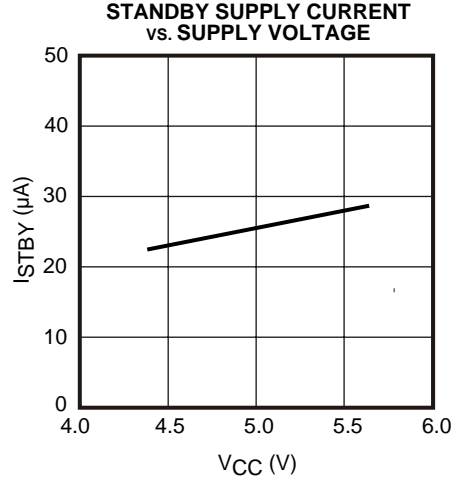
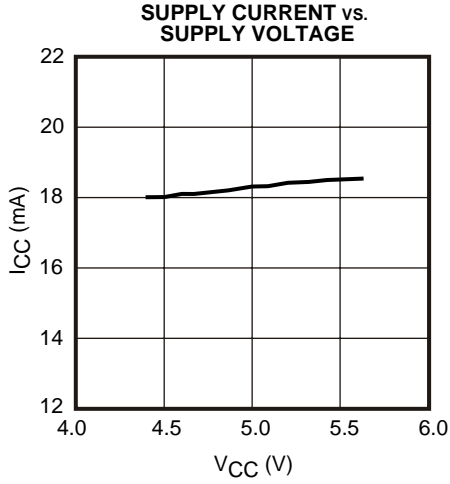

TYPICAL PERFORMANCE CHARACTERISTICS

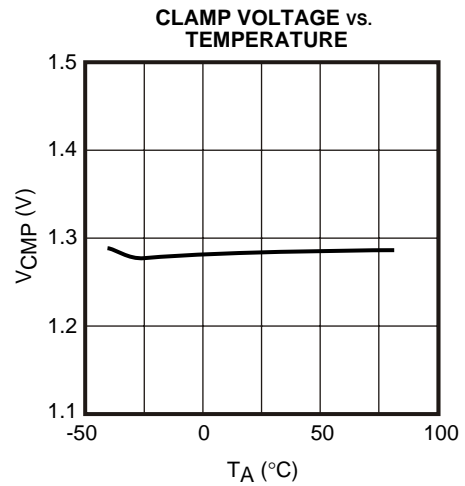
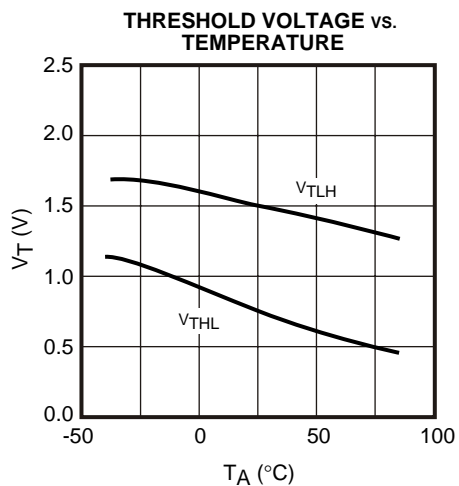
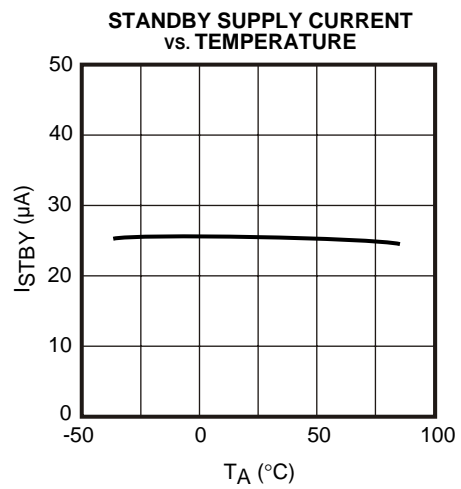
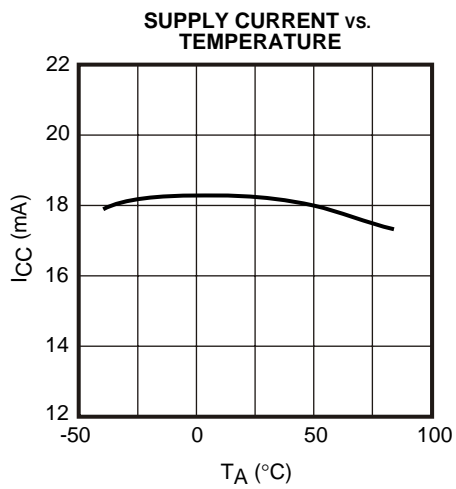
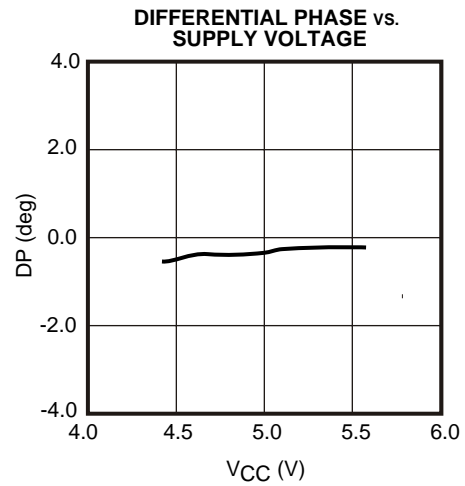
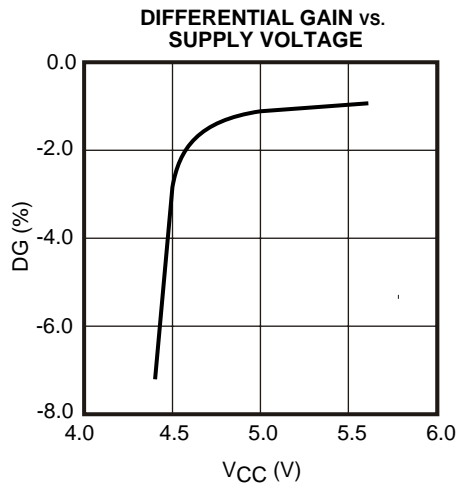

TYPICAL PERFORMANCE CHARACTERISTICS

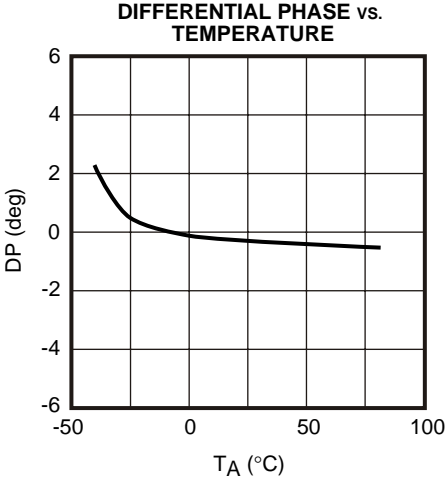
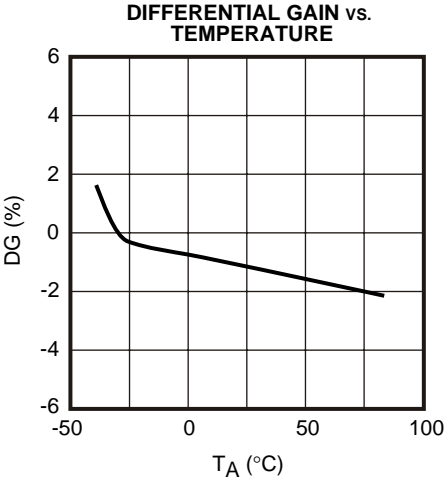
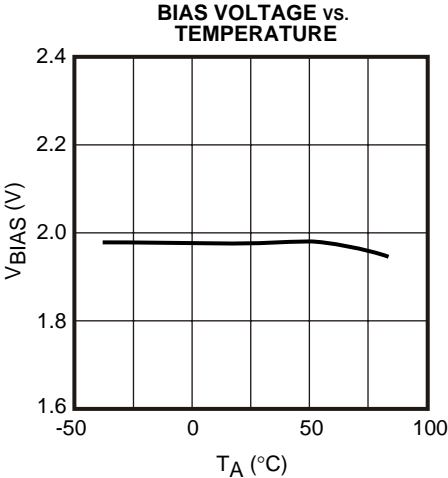

PIN FUNCTION DESCRIPTION

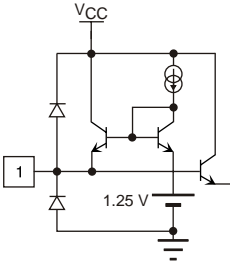
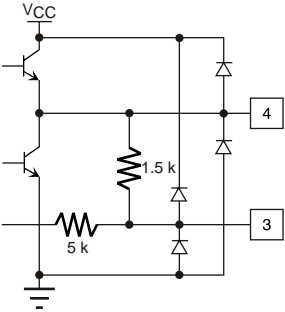
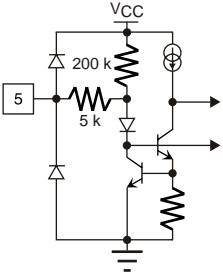
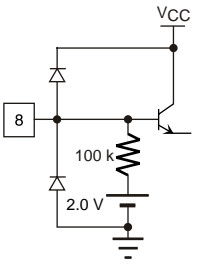
PIN NO.	SYMBOL	INTERNAL EQUIVALENT CIRCUIT	DESCRIPTION
1	Y-INPUT		<p>Luminance Input Terminal.</p> <p>The luminance input signal is clamped at 1.25 V.</p>
2	NC		No Connection Terminal
3 4	SAG OUTPUT		<p>Pin 4: Signal Output Terminal.</p> <p>The output is available to drive a $75\ \Omega + 75\ \Omega$ load.</p> <p>Pin 3: SAG Terminal.</p>
5	STANDBY		<p>Standby Logic Terminal.</p> <p>The device is in the standby mode when Pin 5 is connected to Low.</p> <p>The device is in the operation mode when Pin 5 is connected to High or Open.</p>
6	GND		GND Terminal
7	V _{CC}		Power Supply Terminal
8	C-INPUT		<p>Chrominance Input Terminal.</p> <p>The chrominance input signal is biased to 2.0 V by a $100\ \text{k}\Omega$ bias resistor.</p>

PACKAGE OUTLINE

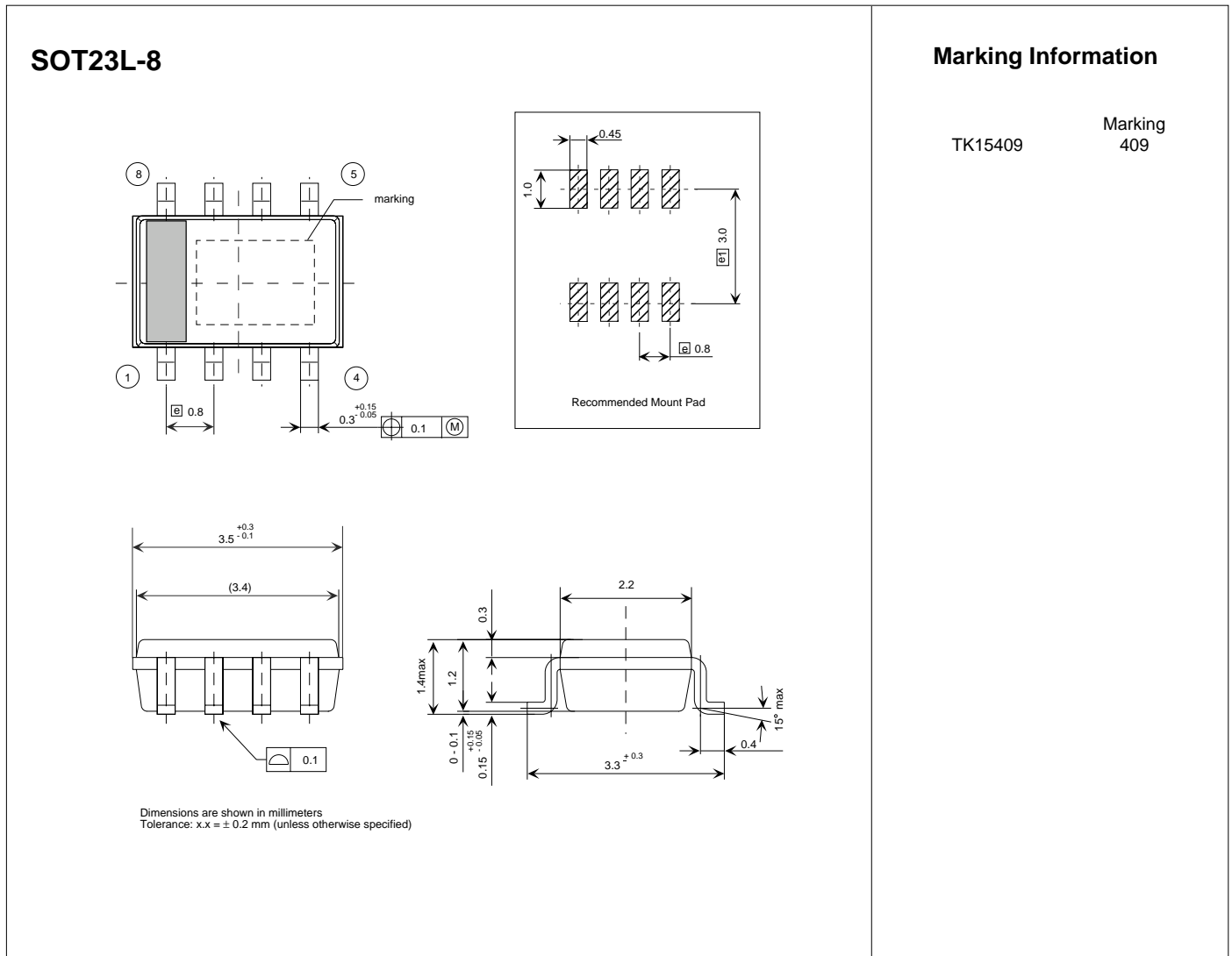

Toko America, Inc. Headquarters
1250 Feehanville Drive, Mount Prospect, Illinois 60056
Tel: (847) 297-0070 Fax: (847) 699-7864

TOKO AMERICA REGIONAL OFFICES

Midwest Regional Office
Toko America, Inc.
1250 Feehanville Drive
Mount Prospect, IL 60056
Tel: (847) 297-0070
Fax: (847) 699-7864

Western Regional Office
Toko America, Inc.
2480 North First Street, Suite 260
San Jose, CA 95131
Tel: (408) 432-8281
Fax: (408) 943-9790

Eastern Regional Office
Toko America, Inc.
107 Mill Plain Road
Danbury, CT 06811
Tel: (203) 748-6871
Fax: (203) 797-1223

Semiconductor Technical Support
Toko Design Center
4755 Forge Road
Colorado Springs, CO 80907
Tel: (719) 528-2200
Fax: (719) 528-2375

Visit our Internet site at <http://www.tokoam.com>

The information furnished by TOKO, Inc. is believed to be accurate and reliable. However, TOKO reserves the right to make changes or improvements in the design, specification or manufacture of its products without further notice. TOKO does not assume any liability arising from the application or use of any product or circuit described herein, nor for any infringements of patents or other rights of third parties which may result from the use of its products. No license is granted by implication or otherwise under any patent or patent rights of TOKO, Inc.