

International IOR Rectifier

30CTH03PbF

Hyperfast Rectifier

Features

- Hyperfast Recovery Time
- Low Forward Voltage Drop
- Low Leakage Current
- 175°C Operating Junction Temperature
- Lead-Free ("PbF" suffix)

$$t_{rr} = 36\text{ns max.}$$

$$I_{F(AV)} = 30\text{Amp}$$

$$V_R = 300\text{V}$$

Description/ Applications

International Rectifier's 300V series are the state of the art Hyperfast recovery rectifiers designed with optimized performance of forward voltage drop and Hyperfast recovery time.

The planar structure and the platinum doped life time control guarantee the best overall performance, ruggedness and reliability characteristics.

These devices are intended for use in the output rectification stage of SMPS, UPS, DC-DC converters as well as freewheeling diodes in low voltage inverters and chopper motor drives.

Their extremely optimized stored charge and low recovery current minimize the switching losses and reduce over dissipation in the switching element and snubbers.

Absolute Maximum Ratings

Parameters		Max	Units
V_{RRM}	Peak Repetitive Reverse Voltage	300	V
$I_{F(AV)}$	Average Rectified Forward Current @ $T_c = 153^\circ\text{C}$ Per Diode	15	A
		Per Device	
I_{FSM}	Non Repetitive Peak Surge Current @ $T_J = 25^\circ\text{C}$	150	
T_J, T_{STG}	Operating Junction and Storage Temperatures	- 65 to 175	$^\circ\text{C}$

Case Styles

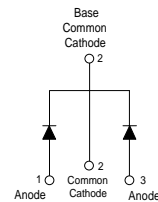
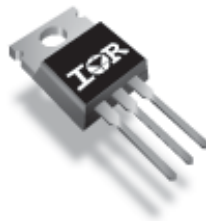

TO-220AB

Electrical Characteristics @ $T_J = 25^\circ\text{C}$ (unless otherwise specified)

Parameters	Min	Typ	Max	Units	Test Conditions
V_{BR}, V_F Breakdown Voltage, Blocking Voltage	300	-	-	V	$I_R = 100\mu\text{A}$
V_F Forward Voltage	-	1.0	1.25	V	$I_F = 15\text{A}, T_J = 25^\circ\text{C}$
	-	0.85	0.95	V	$I_F = 15\text{A}, T_J = 125^\circ\text{C}$
I_R Reverse Leakage Current	-	-	40	μA	$V_R = V_R$ Rated
	-	8	200	μA	$T_J = 125^\circ\text{C}, V_R = V_R$ Rated
C_T Junction Capacitance	-	38	-	pF	$V_R = 300\text{V}$
L_S Series Inductance	-	8	-	nH	Measured lead to lead 5mm from package body

Dynamic Recovery Characteristics @ $T_C = 25^\circ\text{C}$ (unless otherwise specified)

Parameters	Min	Typ	Max	Units	Test Conditions	
t_{rr} Reverse Recovery Time	-	-	36	ns	$I_F = 1\text{A}, di_F/dt = 50\text{A}/\mu\text{s}, V_R = 30\text{V}$	
	-	-	30		$I_F = 1\text{A}, di_F/dt = 100\text{A}/\mu\text{s}, V_R = 30\text{V}$	
	-	33	-	$T_J = 25^\circ\text{C}$	$I_F = 15\text{A}$ $di_F/dt = 200\text{A}/\mu\text{s}$ $V_R = 200\text{V}$	
	-	48	-	$T_J = 125^\circ\text{C}$		
I_{RRM} Peak Recovery Current	-	2.8	-	A		$T_J = 25^\circ\text{C}$
	-	6.5	-			$T_J = 125^\circ\text{C}$
Q_{rr} Reverse Recovery Charge	-	46	-	nC	$T_J = 25^\circ\text{C}$	
	-	160	-		$T_J = 125^\circ\text{C}$	

Thermal - Mechanical Characteristics

Parameters	Min	Typ	Max	Units
T_J Max. Junction Temperature Range	-	-	175	$^\circ\text{C}$
T_{Stg} Max. Storage Temperature Range	- 65	-	175	
R_{thJC} Thermal Resistance, Junction to Case	-	-	1.4	$^\circ\text{C}/\text{W}$
Marking Device	30CTH03			

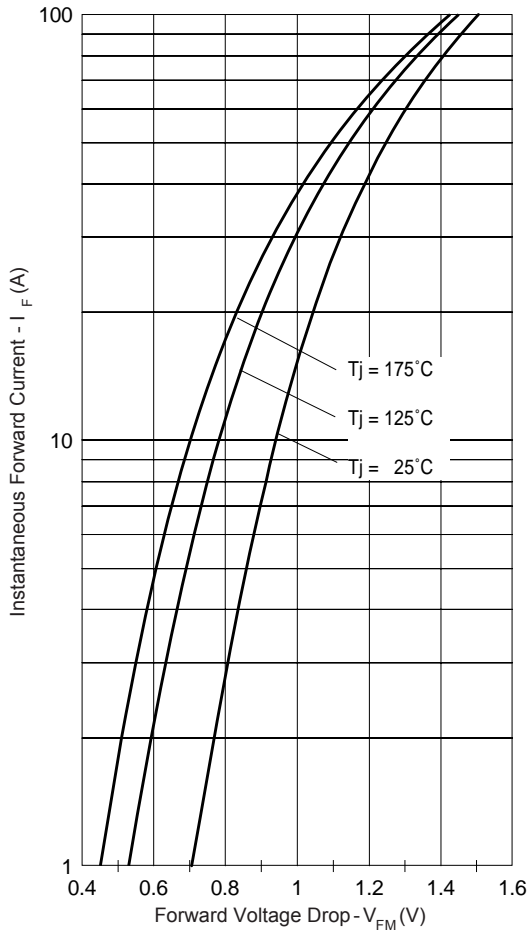

Fig. 1 - Typical Forward Voltage Drop Characteristics

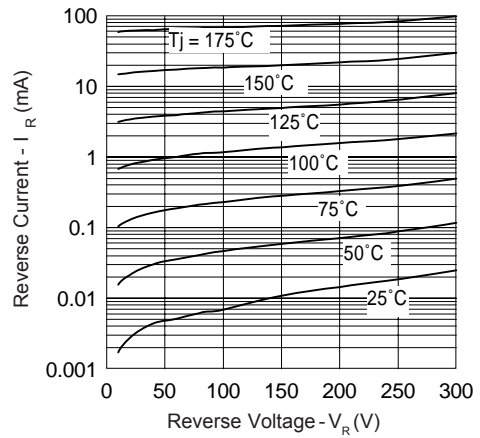

Fig. 2 - Typical Values of Reverse Current Vs. Reverse Voltage

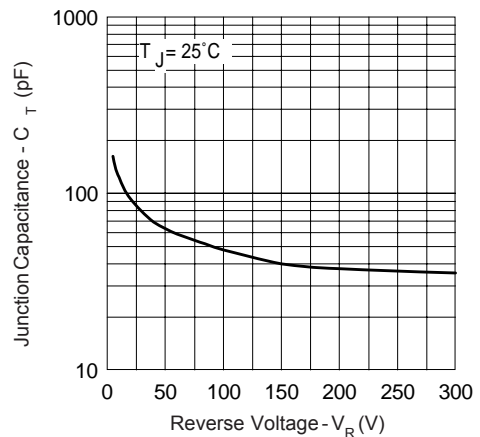

Fig. 3 - Typical Junction Capacitance Vs. Reverse Voltage

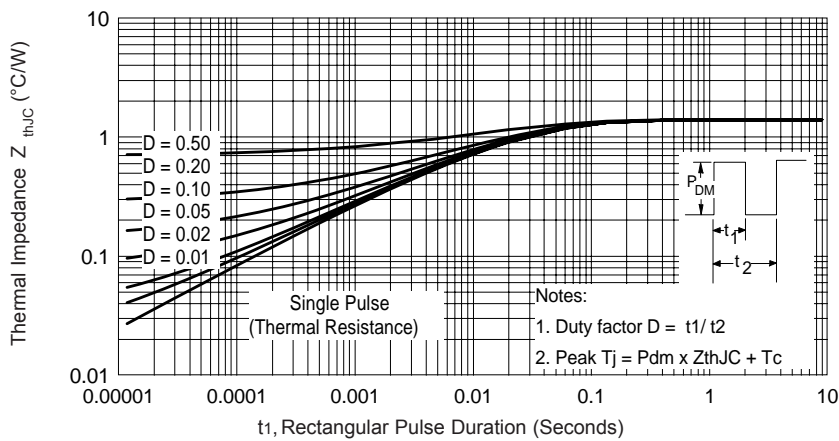

Fig. 4 - Max. Thermal Impedance Z_{thJC} Characteristics

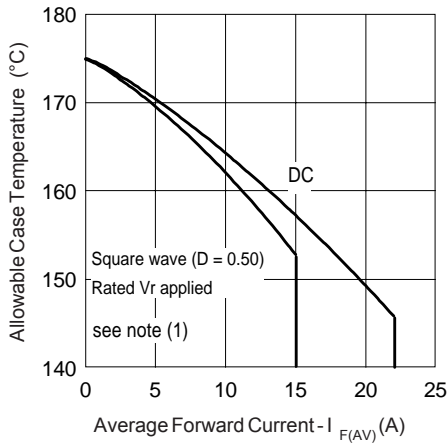

Fig. 5 - Max. Allowable Case Temperature Vs. Average Forward Current

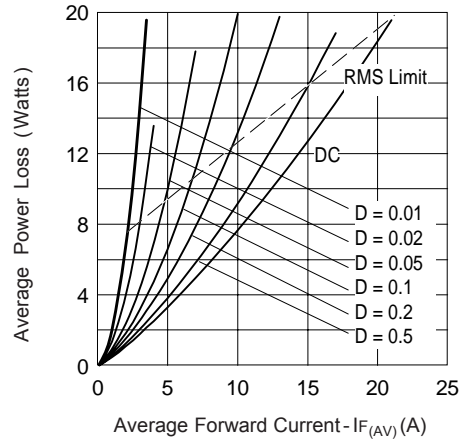

Fig. 6 - Forward Power Loss Characteristics

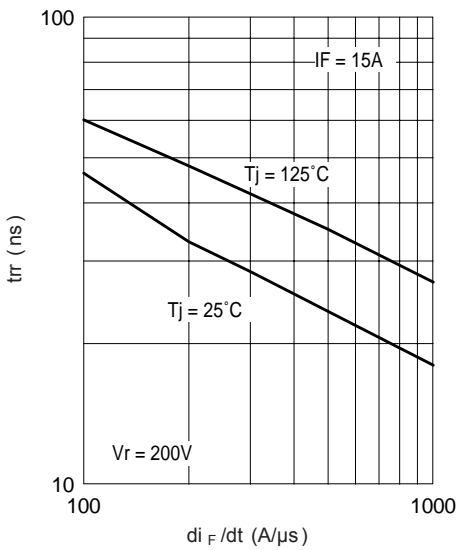

Fig. 7 - Typical Reverse Recovery vs. di_F/dt

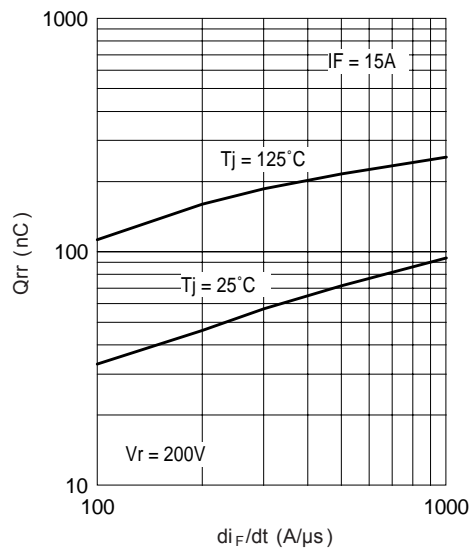

Fig. 8 - Typical Stored Charge vs. di_F/dt

① Formula used: $T_C = T_J - (P_d + P_{d_{REV}}) \times R_{thJC}$;
 $P_d = \text{Forward Power Loss} = I_{F(AV)} \times V_{FM} @ (I_{F(AV)} / D)$ (see Fig. 6);
 $P_{d_{REV}} = \text{Inverse Power Loss} = V_{R1} \times I_{R1} (1 - D)$; $I_{R1} @ V_{R1} = \text{rated } V_R$

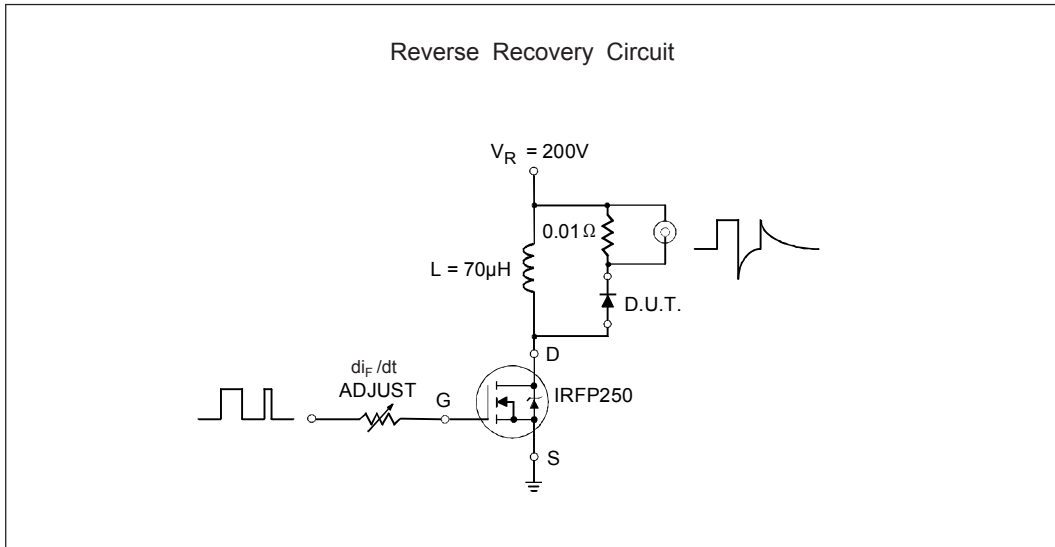

Fig. 9- Reverse Recovery Parameter Test Circuit

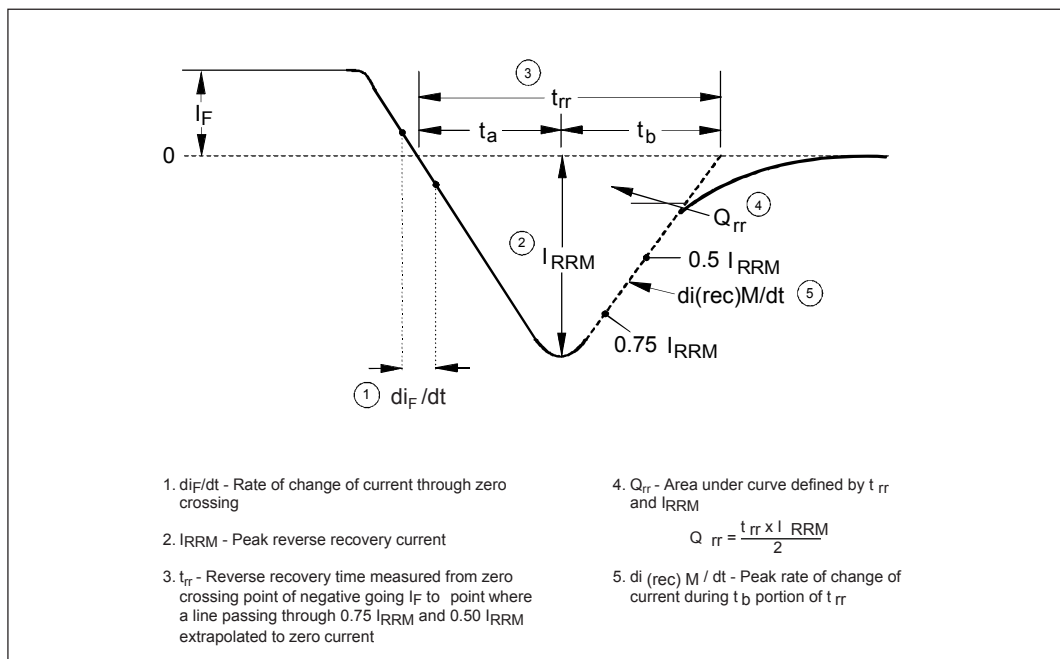
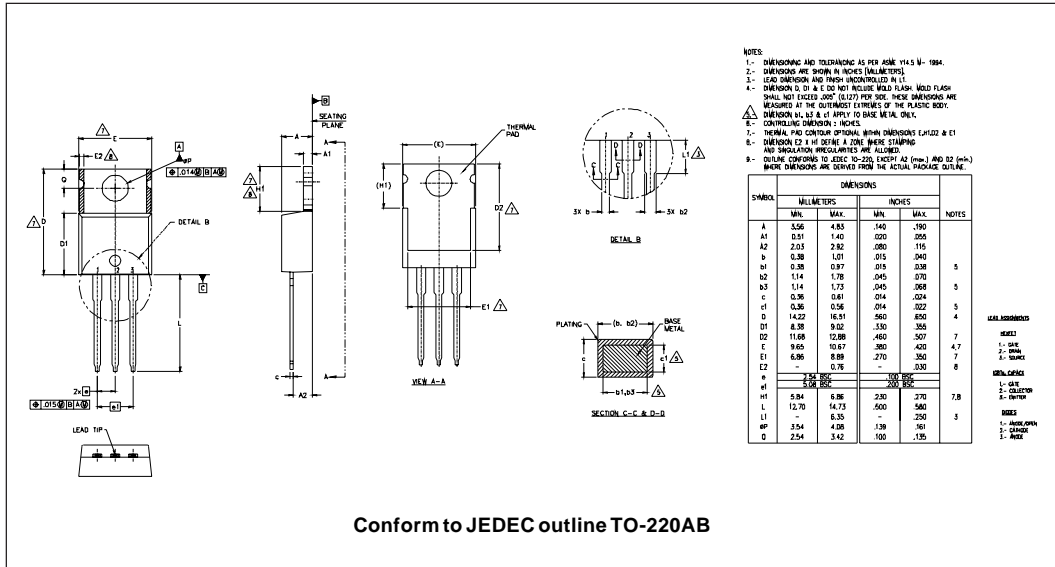
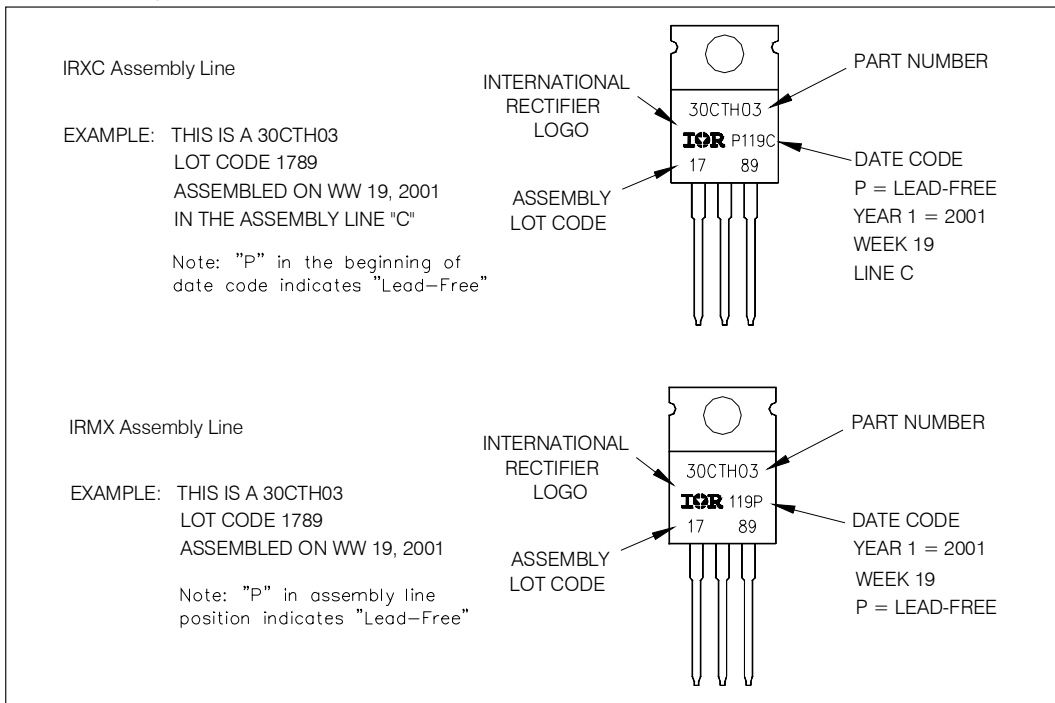

Fig. 10 - Reverse Recovery Waveform and Definitions

Outline Table



Part Marking Information



Ordering Information Table

Device Code	
30	C
T	H
03	PbF
①	②
③	④
⑤	⑥
1	- Current Rating (30 = 30A)
2	- C = Common Cathode
3	- Package T = TO-220
4	- H = HyperFast Recovery
5	- Voltage Rating (03 = 300V)
6	- • none = Standard Production • PbF = Lead-Free
Tube Standard Pack Quantity : 50 pieces	

Data and specifications subject to change without notice.
 This product has been designed and qualified for AEC Q101 Level and Lead-Free.
 Qualification Standards can be found on IR's Web site.