



CHTA/CHTB16

High Temperature 150°C Series

16Amp - 400/600/800V - TRIAC

Applications

- Heat Regulation
 - Ovens
 - Coffee Makers
 - Cookers
- Light Dimming
- Control of Inductive Loads
 - Motors
 - Transformers

- > Superior Commutating Performance at High Temperature $(di/dt)_c = 14A/ms @ (dv/dt)_c = 50V/\mu s$
- > Ideal for Most Demanding Applications
- > Alternistor/No Snubber Type
- > IGT 35 mA Max.
- > VDRM/VRMM 400, 600, 800V

Absolute Maximum Ratings

	CONDITIONS	SYMBOL	RATING
RMS On-State Current (full sine wave)	$T_c = 125^\circ C$ $T_c = 115^\circ C$	TO-220AB TO-220AB Iso $I_{T(RMS)}$	16A
Non Repetitive Surge Peak On-State Current (Full Cycle, T_j Initial = 25°C)	F = 50 Hz F = 60 Hz	I_{TSM}	180A 190A
I^2t Value for fusing	$t_p = 10$ ms	I^2t	150A ² s
Critical rate of rise of on-state current $I_G = 2 \times I_{GT}$, $t_r < 100$ ns, $T_j = 150^\circ C$		di/dt	100A/ μs
Peak Gate Current @ $T_j = 150^\circ C$	$t_p = 20$ μs	I_{GM}	4A
Average Gate Power Dissipation @ $T_j = 150^\circ C$		PG(AV)	1W
Storage Temperature Range		T_{stg}	-40 to +150°C
Operating Junction Temperature Range		T_j	-40 to +150°C
Isolation Voltage (CHTA Series only)		V_{ISO}	2500 V_{RMS}

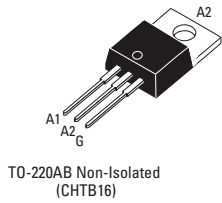
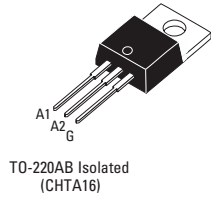

Electrical Characteristics

I_{GT} MAX @ $V_D = 12$ V, $R_L = 30\Omega$ ^{NOTE 1}	QI-II-III	35mA
V_{GT} MAX @ $V_D = 12$ V, $R_L = 30\Omega$	QI-II-III	1.3V
V_{GD} MIN @ $V_D = V_{DRM}$, $R_L = 3.3k\Omega$ $T_j = 150^\circ C$	QI-II-III	0.15V
I_H MAX @ $I_T = 100$ mA ^{NOTE 2}		35mA
I_L MAX @ $I_G = 1.2 I_{GT}$	QI-III	50mA
I_L MAX @ $I_G = 1.2 I_{GT}$	Q-II	80mA
dv/dt MIN @ $V_D = 67\% V_{DRM}$ (gate open) ^{NOTE 2} $T_j = 150^\circ C$		500V/ μs
$(di/dt)_c$ MIN without snubber ^{NOTES 2 & 4} $T_j = 150^\circ C$		14A/ms

Static Characteristics

V_T MAX @ $I_{TM} = 22.5$ A, $t_p = 380\mu s$ ^{NOTE 2} $T_j = 25^\circ C$		1.5V
V_{to} MAX @ Threshold Voltage ^{NOTE 2} $T_j = 150^\circ C$		0.8V
R_d MAX @ Dynamic Resistance ^{NOTE 2} $T_j = 150^\circ C$		25m Ω
I_{DRM} MAX @ $V_{DRM} = V_{RRM}$ $T_j = 25^\circ C$		5 μA
I_{RRM} MAX @ $V_{DRM} = V_{RRM}$ $T_j = 150^\circ C$		5.5mA

GENERAL NOTES

1. Minimum IGT is guaranteed at 5% of IGT max.
2. For both polarities of A2 referenced to A1
3. All parameters at 25 degrees C unless otherwise specified.
4. Commutating $dv/dt = 50V/\mu s$, (exponential to 200Vpk)

ISO9001 Certified

Thermal Resistances

		SYMBOL	RATING
Junction to Case (AC)	TO-220AB	$R_{th(j-c)}$	1.4°C/W
Junction to Case (AC)	TO-220AB Isolated	$R_{th(j-c)}$	2.3°C/W
Junction to Ambient	TO-220AB	$R_{th(j-a)}$	60°C/W
Junction to Ambient	TO-220AB Isolated	$R_{th(j-a)}$	60°C/W

Part Number Designation

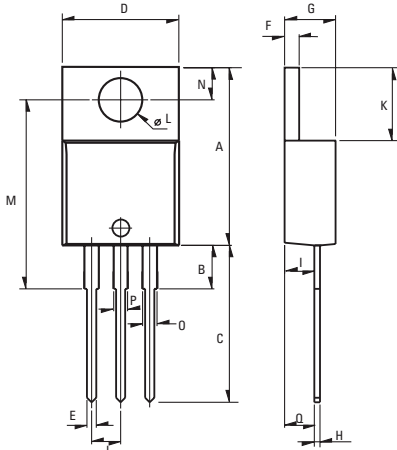
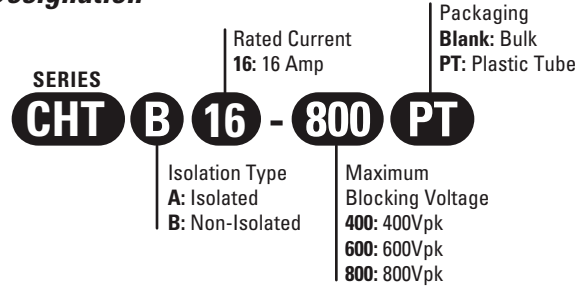

Weight: 2.3g (0.08 oz)

Dimensions

REF.	Millimeters			Inches		
	Min.	Typ.	Max.	Min.	Typ.	Max.
A	15.24		15.75	0.6		0.62
B		3.23			0.127	
C	12.78		13.79	0.503		0.543
D	9.96		10.36	0.392		0.408
E	0.69		0.94	0.027		0.037
F	1.22		1.32	0.048		0.052
G	4.62		4.83	0.182		0.19
H	0.46		0.61	0.018		0.024
I	2.49		2.84	0.098		0.112
J	2.39		2.69	0.094		0.106
K	6.48		6.88	0.255		0.271
L	3.78		3.89	0.149		0.153
M	15.49	16	16.51	0.61	0.63	0.65
N	2.59		2.9	0.102		0.114
O	0.99		1.55	0.039		0.061
P	0.99		1.55	0.039		0.061
Q		2.67			0.105	

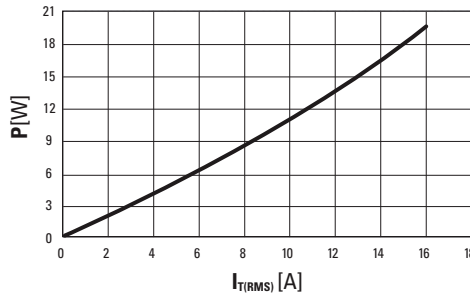

Fig. 1: Power dissipation versus RMS on-state current (full cycle).

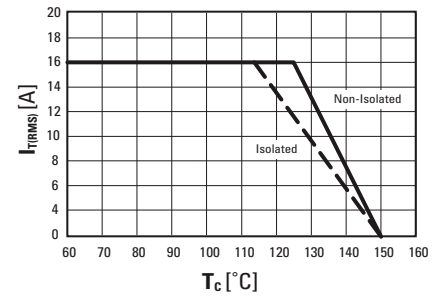

Fig. 2: RMS on-state current versus case temperature (full cycle)

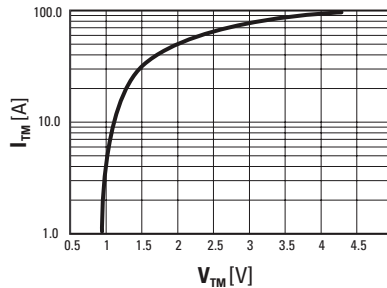

Fig. 3: On-state current versus on-state voltage (instantaneous values)

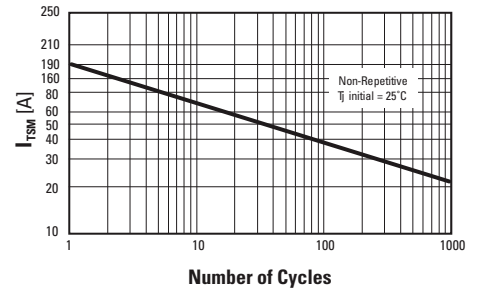

Fig. 4: Non-repetitive surge peak on-state current versus number of cycles.

ISO9001 Certified

Approvals

UL Recognized Component - E72445
(For CHTA series)

USA

Sales Support (866) 258-5057
Tech Support (866) 258-5057
Fax (619) 690-7432
Email: sales@cynergy3.com
Cynergy3 Components
2320 Paseo de las Americas, Suite 104
San Diego, CA 92154

EUROPE - UK

Telephone +44 (0) 1202 897969
Fax +44 (0) 1202 891918
Email: sales@cynergy3.com
Cynergy3 Components Ltd.
7 Cobham Road
Ferndown Industrial Estate
Wimborne, Dorset BH21 7PE

ASIA - Thailand

Telephone +66 (0)2 665 2517
Fax +66 (0)2 665 2588
Cynergy3 Components Asia
18/8 Fico Place 12th Floor
Soi Sukhumvit 21 (Asoke)
Klongtoey Nua, Wattana
Bangkok, Thailand 10110