



HIGH IP3 GaAs MMIC MIXER with INTEGRATED LO AMPLIFIER, 400 - 650 MHz

Typical Applications

The HMC585MS8G / HMC585MS8GE are ideal for:

- Basestations & Repeaters
- GSM, GPRS & EDGE
- CDMA & W-CDMA
- Cable Modem Termination Systems

Features

- High Input IP3: +33 dBm
- Conversion Loss: 9 dB
- Low LO Drive: -2 to +4 dBm
- Single Supply: +5V @ 50 mA
- Compact MSOP Package: 14.8mm²

Functional Diagram

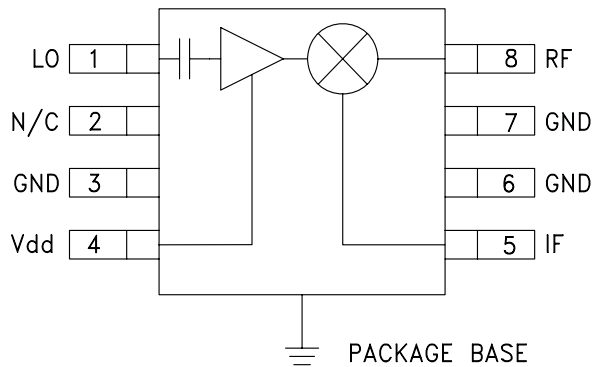

General Description

The HMC585MS8G & HMC585MS8GE are high dynamic range passive MMIC mixers with integrated LO amplifiers in plastic surface mount 8 lead Mini Small Outline Packages (MSOP) covering an RF range of 400 MHz to 650 MHz. The LO range of 300 MHz to 750 MHz supports both high side and low side LO applications. Excellent input IP3 performance of +33 dBm for down conversion and +27 dBm for up conversion is provided for 2.5G & 3G applications at an LO drive of 0 dBm. RF conversion loss is 9 dB typical. The DC to 250 MHz IF frequency response will satisfy a wide range of Tx and Rx frequency plans.

Electrical Specifications, $T_A = +25^\circ\text{C}$, LO = 0 dBm, IF = 50 MHz*, Vdd = 5V

Parameter	Min.	Typ.	Max.	Units
Frequency Range, RF	400 - 650			MHz
Frequency Range, LO	300 - 750			MHz
Frequency Range, IF	DC - 250			GHz
Conversion Loss		9.0	11	dB
LO to RF Isolation		7		dB
LO to IF Isolation	10	15		dB
IP3 (Input)	30	33		dBm
1 dB Gain Compression (Input)		22		dBm
LO Input Drive Level (Typical)	-2 to +4			dBm
Supply Current		50		mA

*Unless otherwise noted, all measurements performed as a downconverter, with high side LO & IF = 50 MHz.



HIGH IP3 GaAs MMIC MIXER with INTEGRATED LO AMPLIFIER, 400 - 650 MHz

Conversion Gain vs. Temperature @ LO = 0 dBm

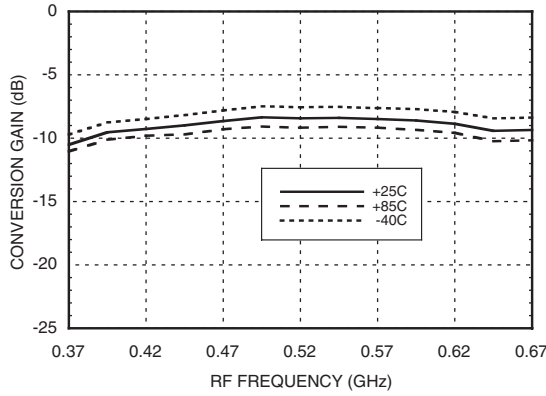

Isolation @ LO = 0 dBm

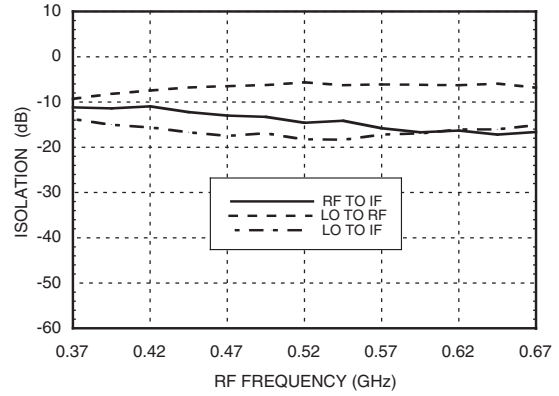

Conversion Gain vs. LO Drive

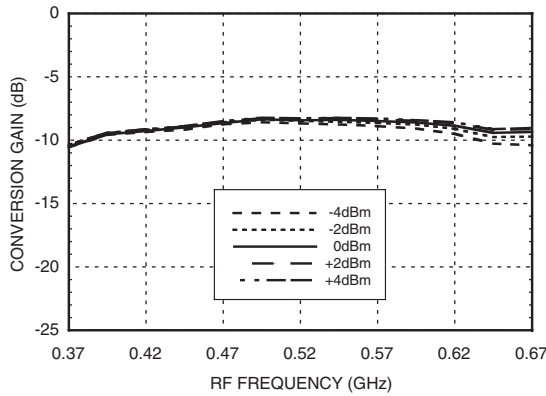

Return Loss @ LO = 0 dBm

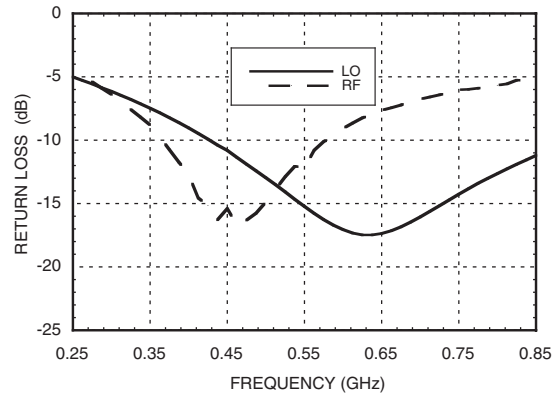

Upconverter Performance Conversion Gain @ LO = 0 dBm

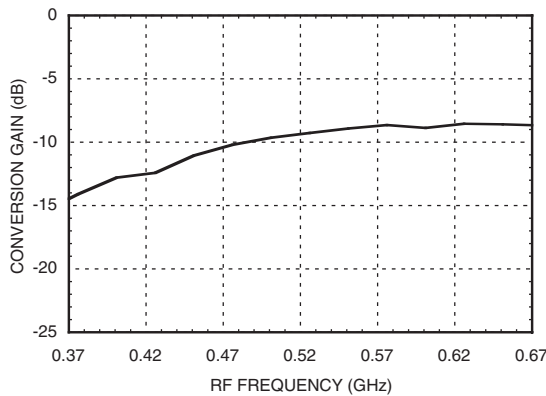

IF Bandwidth @ LO = 0 dBm

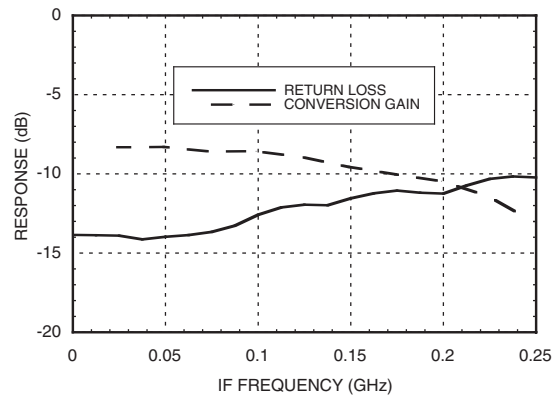

Unless otherwise noted, all measurements performed as a downconverter, with high side LO & IF = 50 MHz.

For price, delivery, and to place orders, please contact Hittite Microwave Corporation:
 20 Alpha Road, Chelmsford, MA 01824 Phone: 978-250-3343 Fax: 978-250-3373
 Order On-line at www.hittite.com

HIGH IP3 GaAs MMIC MIXER with INTEGRATED LO AMPLIFIER, 400 - 650 MHz



Input IP3 vs. Temperature @ LO= 0 dBm

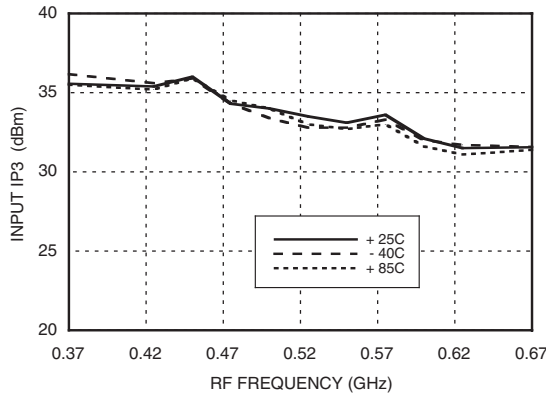

Input IP3 vs. LO Drive

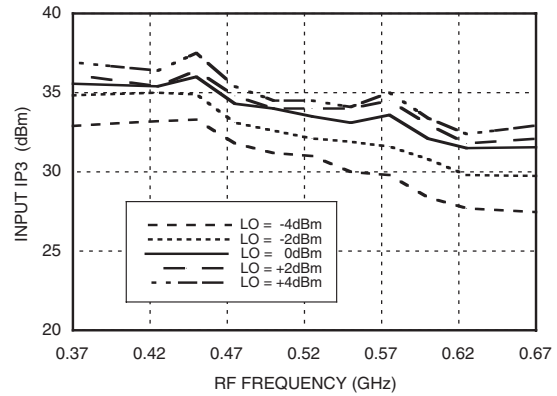

Input IP2 vs. Temperature @ LO= 0 dBm

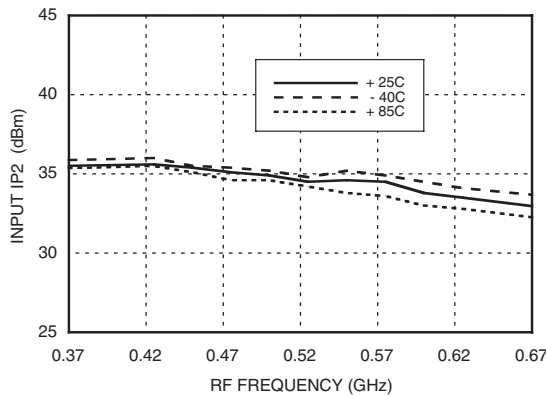

Input IP2 vs. LO Drive

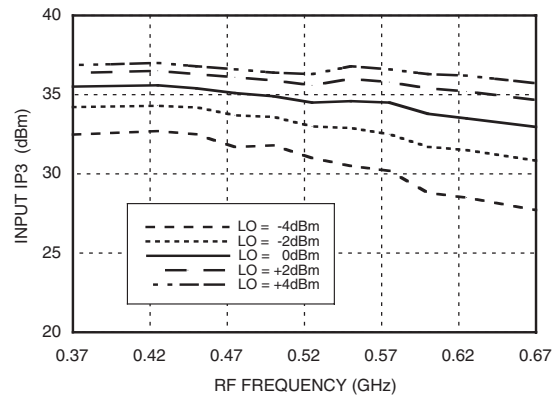

Input P1dB vs. Temperature @ LO= 0 dBm

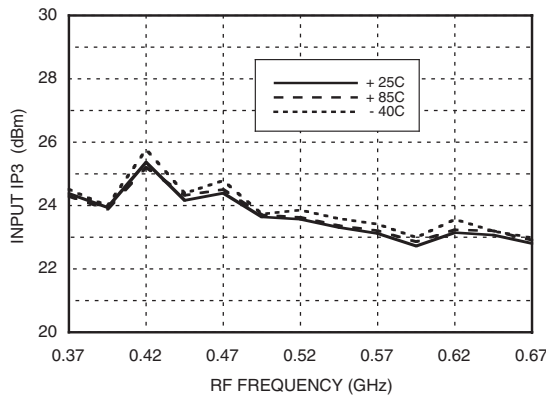

Upconverter IP3 vs. LO Drive, IF= 50 MHz

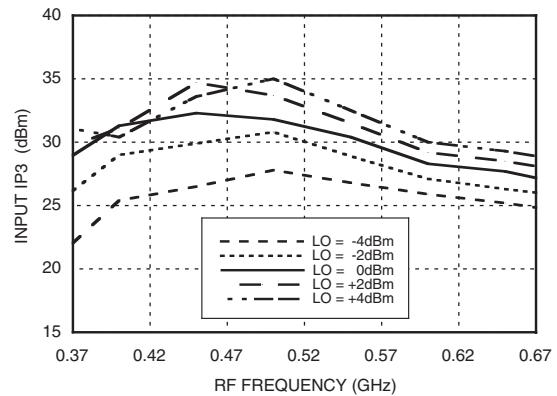

Unless otherwise noted, all measurements performed as a downconverter, with high side LO & IF = 50 MHz.

For price, delivery, and to place orders, please contact Hittite Microwave Corporation:
 20 Alpha Road, Chelmsford, MA 01824 Phone: 978-250-3343 Fax: 978-250-3373
 Order On-line at www.hittite.com

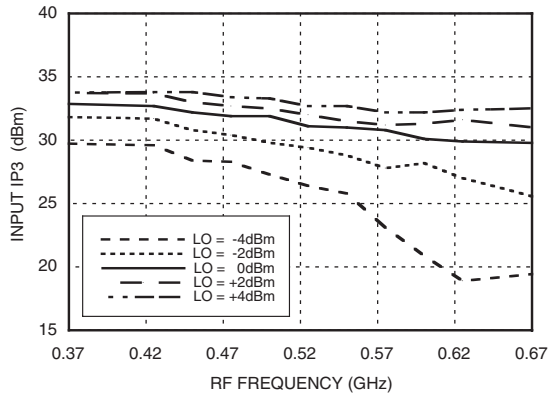
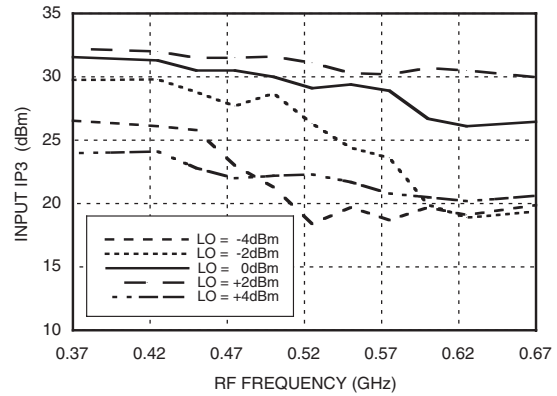
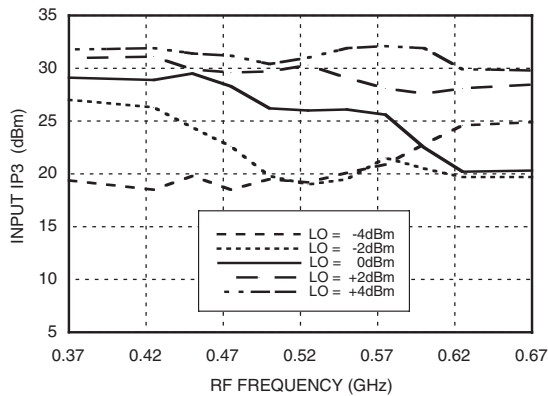
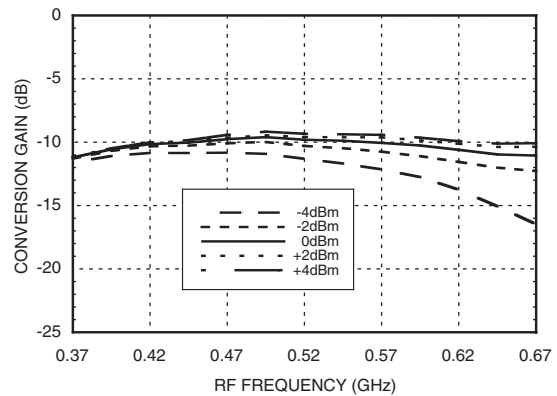
Input IP3 vs. LO Drive, IF= 100 MHz

Input IP3 vs. LO Drive, IF= 150 MHz

Input IP3 vs. LO Drive, IF= 200 MHz

**Conversion Gain vs.
LO Drive, IF= 200 MHz**

Unless otherwise noted, all measurements performed as a downconverter, with high side LO & IF = 50 MHz.

For price, delivery, and to place orders, please contact Hittite Microwave Corporation:
20 Alpha Road, Chelmsford, MA 01824 Phone: 978-250-3343 Fax: 978-250-3373
Order On-line at www.hittite.com



MICROWAVE CORPORATION v00.0806



HMC585MS8G / 585MS8GE

HIGH IP3 GaAs MMIC MIXER with INTEGRATED LO AMPLIFIER, 400 - 650 MHz

MxN Spurious Outputs

mRF	nLO				
	0	1	2	3	4
0	xx	-4	26	-1	8
1	5	0	27	22	24
2	61	63	50	50	63
3	20	24	22	27	0
4	7	8	-1	26	-4

RF Freq = 0.5 GHz @ -10 dBm
 LO Freq = 0.4 GHz @ 0 dBm
 All values in dBc below IF power level (RF - LO).

Harmonics of LO

LO Freq GHz	nLO Spur at RF Port			
	1	2	3	4
0.3	17	36	31	39
0.4	10	40	20	33
0.5	6	32	18	31
0.6	6	34	23	33
0.7	6	28	34	41
0.8	6	26	48	xx

LO power = 0 dBm
 All values in dBc below input LO level measured at RF port.



MIXERS - SMT

Absolute Maximum Ratings

RF/IF Input	+27 dBm
LO Drive	+10 dBm
Bias Supply (Vdd)	+7 Vdc
Channel Temperature	150 °C
Continuous Pdiss (T = 85°C) (Derate 13.2 mW/°C above 85°C)	0.85 W
Storage Temperature	-65 to +150 °C
Operating Temperature	-40 to +85 °C
IF DC Current	±40 mA



ELECTROSTATIC SENSITIVE DEVICE
OBSERVE HANDLING PRECAUTIONS

Outline Drawing

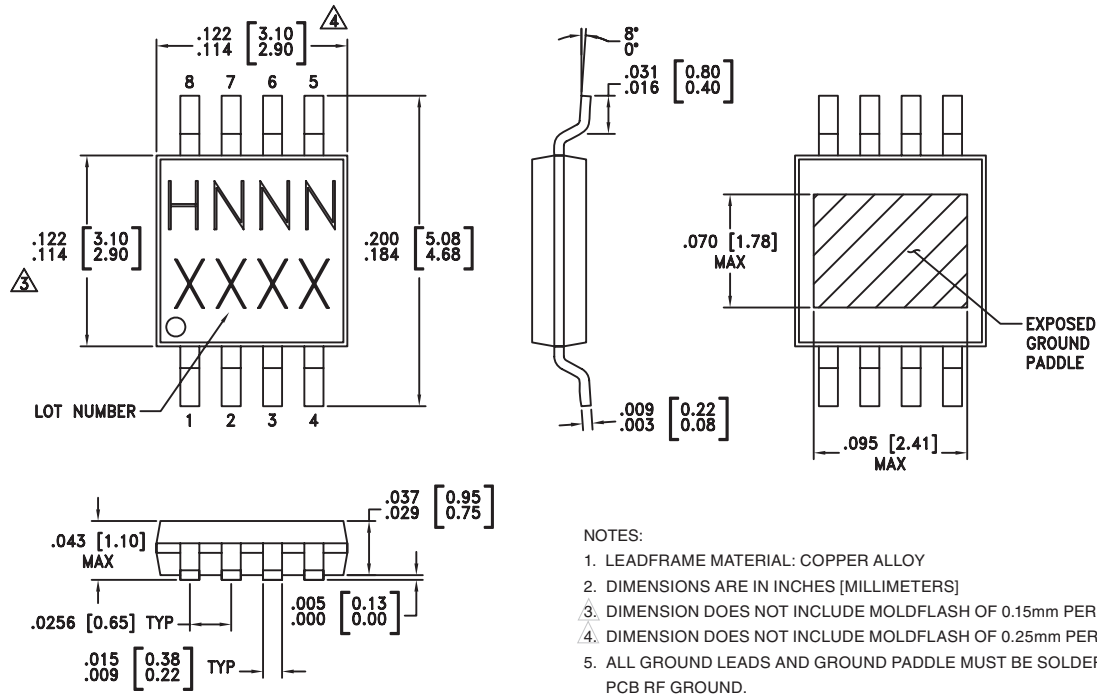

Package Information

Part Number	Package Body Material	Lead Finish	MSL Rating	Package Marking ^[3]
HMC585MS8G	Low Stress Injection Molded Plastic	Sn/Pb Solder	MSL1 ^[1]	H585 XXXX
HMC585MS8GE	RoHS-compliant Low Stress Injection Molded Plastic	100% matte Sn	MSL1 ^[2]	H585 XXXX



[1] Max peak reflow temperature of 235 °C

[2] Max peak reflow temperature of 260 °C

[3] 4-Digit lot number XXXX

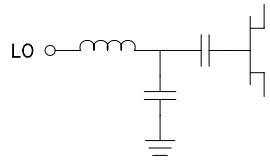

Pin Descriptions

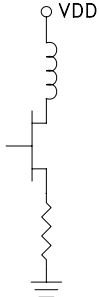
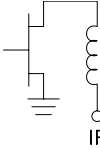
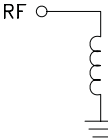
Pin Number	Function	Description	Interface Schematic
1	LO	This pin is AC coupled & matched to 50 Ohms from 300 to 750 MHz.	
2	N/C	Not connected.	
3, 6, 7	GND	This pin must be connected to RF ground.	
4	Vdd	Power supply for LO amplifier. An external RF bypass capacitor is required.	
5	IF Port	This pin is DC coupled. For applications not requiring operation to DC this port should be DC blocked externally using a series capacitor. Choose value of capacitor to pass IF frequency desired. For operation to DC, this pin must not sink/source more than 40 mA of current or failure may result.	
8	RF Port	This pin is DC coupled & matched to 50 Ohm from 400 to 650 MHz	

Evaluation PCB

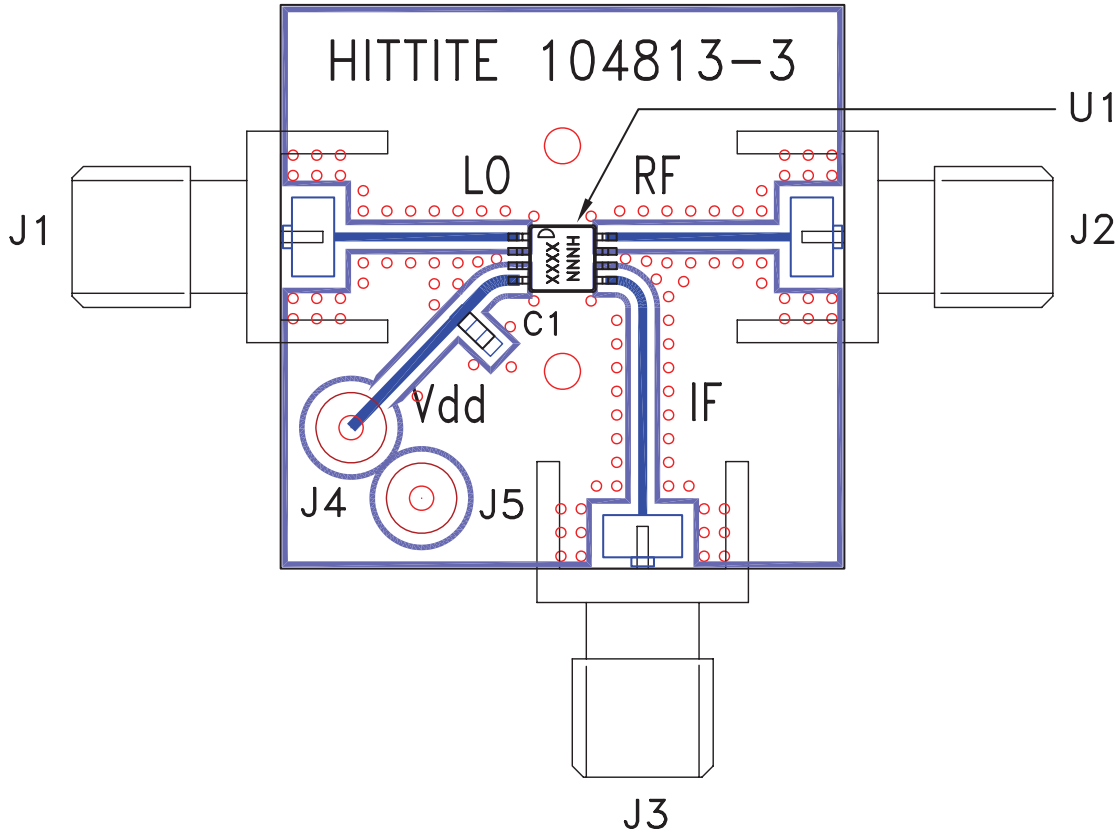

List of Materials for Evaluation PCB 114445 [1]

Item	Description
J1 - J3	PCB Mount SMA RF Connector
J4 - J5	DC Pin
C1	10,000 pF Chip Capacitor, 0603 Pkg.
U1	HMC585MS8G / HMC585MS8GE Mixer
PCB [2]	104813 Evaluation Board, 1.0" x 1.0"

[1] Reference this number when ordering complete evaluation PCB

[2] Circuit Board Material: Rogers 4350

The circuit board used in the final application should use RF circuit design techniques. Signal lines should have 50 ohm impedance while the package ground leads and exposed paddle should be connected directly to the ground plane similar to that shown. A sufficient number of VIA holes should be used to connect the top and bottom ground planes. The evaluation circuit board shown is available from Hittite upon request.