

Power TOPLED Hyper-Bright LED

LA E67B



Vorläufige Daten / Preliminary Data

Besondere Merkmale

- **Gehäusetypp:** weißes P-LCC-4 Gehäuse
- **Besonderheit des Bauteils:** mehr Licht durch erhöhten optischen Wirkungsgrad; höhere Umgebungstemperatur bei gleichem Strom im Vergleich zur TOPLED möglich
- **Wellenlänge:** 617 nm (amber)
- **Abstrahlwinkel:** Lambertischer Strahler (120°)
- **Technologie:** InGaAlP
- **optischer Wirkungsgrad:** 21 lm/W
- **Gruppierungsparameter:** Lichtstärke, Durchflussspannung
- **Verarbeitungsmethode:** für alle SMT-Bestücktechniken geeignet
- **Lötmethode:** IR Reflow Löten und Wellenlöten (TTW)
- **Vorbehandlung:** nach JEDEC Level 2
- **Gurtung:** 8 mm Gurt mit 2000/Rolle, \varnothing 180 mm oder 8000/Rolle, \varnothing 330 mm
- **ESD-Festigkeit:** ESD-sicher bis 2 kV nach EOS/ESD-5.1-1993

Anwendungen

- Ampelanwendung
- Hinterleuchtung (LCD, Schalter, Tasten, Displays, Werbebeleuchtung)
- Innen- und Außenbeleuchtung im Automobilbereich (z.B. Instrumentenbeleuchtung und Bremslichter)
- Ersatz von Kleinst-Glühlampen
- Markierungsbeleuchtung (z.B. Stufen, Fluchtwege, u.ä.)
- Signal- und Symbolleuchten

Features

- **package:** white P-LCC-4 package
- **feature of the device:** more light due to higher optical efficiency; higher ambient temperature at the same current possible compared to TOPLED
- **wavelength:** 617 nm (amber)
- **viewing angle:** Lambertian Emitter (120°)
- **technology:** InGaAlP
- **optical efficiency:** 21 lm/W
- **grouping parameter:** luminous intensity, forward voltage
- **assembly methods:** suitable for all SMT assembly methods
- **soldering methods:** IR reflow soldering and TTW soldering
- **preconditioning:** acc. to JEDEC Level 2
- **taping:** 8 mm tape with 2000/reel, \varnothing 180 mm or 8000/reel, \varnothing 330 mm
- **ESD-withstand voltage:** up to 2 kV acc. to EOS/ESD-5.1-1993

Applications

- traffic lights
- backlighting (LCD, switches, keys, displays, illuminated advertising)
- interior and exterior automotive lighting (e.g. dashboard backlighting and brake lights)
- substitution of micro incandescent lamps
- marker lights (e.g. steps, exit ways, etc.)
- signal and symbol luminaire

Typ	Emissions- farbe	Farbe der Lichtaustritts- fläche	Lichtstärke	Lichtstrom	Bestellnummer
Type	Color of Emission	Color of the Light Emitting Area	Luminous Intensity $I_F = 50 \text{ mA}$ $I_V \text{ (mcd)}$	Luminous Flux $I_F = 50 \text{ mA}$ $\Phi_V \text{ (mlm)}$	Ordering Code
LA E67B-U2AA-11	amber	colorless clear	560 ...1400	2900 (typ.)	Q62703-Q5965

Anm.: -11 gesamter Farbbereich (siehe **Seite 4**)

-11 gesamter Durchlassspannungsbereich, Lieferung in Einzelgruppen (siehe **Seite 5**)

Die Standardlieferform von Serientypen beinhaltet eine untere bzw. eine obere Familiengruppe, die aus nur 3 bzw. 4 Halbgruppen besteht. Einzelne Halbgruppen sind nicht erhältlich.

In einer Verpackungseinheit / Gurt ist immer nur eine Halbgruppe enthalten.

Dimmverhältnis im Gleichstrom-Betrieb max. 5:1

Note: -11 Total color tolerance range (please see **page 4**)

-11 Total forward voltage tolerance, delivery in single groups (see **page 5**)

The standard shipping format for serial types includes a lower or upper family group of 3 or 4 individual groups. Individual half groups are not available.

No packing unit / tape ever contains more than one luminous intensity half group.

Dimming range for direct current mode max. 5:1

Grenzwerte
Maximum Ratings

Bezeichnung Parameter	Symbol Symbol	Wert Value	Einheit Unit
Betriebstemperatur Operating temperature range	T_{op}	- 40 ... + 100	°C
Lagertemperatur Storage temperature range	T_{stg}	- 40 ... + 100	°C
Sperrschichttemperatur Junction temperature	T_j	+ 125	°C
Durchlassstrom Forward current	I_F	70	mA
Stoßstrom Surge current $t \leq 10 \mu s, D = 0.1$	I_{FM}	0.1	A
Sperrspannung Reverse voltage	V_R	5	V
Leistungsaufnahme Power consumption $T_A \leq 25 \text{ °C}$	P_{tot}	180	mW
Wärmewiderstand Thermal resistance Sperrschicht/Umgebung Junction/ambient	$R_{th JA}$	300	K/W
Sperrschicht/Löt看pad Junction/soldering point Montage auf PC-Board FR 4 (Padgröße $\geq 16 \text{ mm}^2$) mounted on PC board FR 4 (pad size $\geq 16 \text{ mm}^2$)	$R_{th JS}$	130	K/W

Kennwerte ($T_A = 25\text{ °C}$)

Characteristics

Bezeichnung Parameter	Symbol Symbol	Wert Value	Einheit Unit
Wellenlänge des emittierten Lichtes (typ.) Wavelength at peak emission $I_F = 50\text{ mA}$	λ_{peak}	624	nm
Dominantwellenlänge ¹⁾ (typ.) Dominant wavelength $I_F = 50\text{ mA}$	λ_{dom}	617 ± 5	nm
Spektrale Bandbreite bei 50 % $I_{\text{rel max}}$ (typ.) Spectral bandwidth at 50 % $I_{\text{rel max}}$ $I_F = 50\text{ mA}$	$\Delta\lambda$	18	nm
Abstrahlwinkel bei 50 % I_V (Vollwinkel) (typ.) Viewing angle at 50 % I_V	2ϕ	120	Grad deg.
Durchlassspannung ²⁾ (typ.) Forward voltage $I_F = 50\text{ mA}$	V_F V_F	2.2 2.5	V V
Sperrstrom (typ.) Reverse current $V_R = 5\text{ V}$	I_R I_R	0.01 10	μA μA
Temperaturkoeffizient von λ_{peak} (typ.) Temperature coefficient of λ_{peak} $I_F = 50\text{ mA}; -10\text{ °C} \leq T \leq 100\text{ °C}$	$TC_{\lambda_{\text{peak}}}$	0.15	nm/K
Temperaturkoeffizient von λ_{dom} (typ.) Temperature coefficient of λ_{dom} $I_F = 50\text{ mA}; -10\text{ °C} \leq T \leq 100\text{ °C}$	$TC_{\lambda_{\text{dom}}}$	0.07	nm/K
Temperaturkoeffizient von V_F (typ.) Temperature coefficient of V_F $I_F = 50\text{ mA}; -10\text{ °C} \leq T \leq 100\text{ °C}$	TC_V	- 3.7	mV/K
Optischer Wirkungsgrad (typ.) Optical efficiency $I_F = 50\text{ mA}$	η_{opt}	21	lm/W

¹⁾ Wellenlängen werden mit einer Stromeinprägungsdauer von 25 ms und einer Genauigkeit von $\pm 1\text{ nm}$ ermittelt.
Wavelengths are tested at a current pulse duration of 25 ms and a tolerance of $\pm 1\text{ nm}$.

²⁾ Durchlassspannungsgruppen werden mit einer Stromeinprägungsdauer von 1 ms und einer Genauigkeit von $\pm 0,1\text{ V}$ ermittelt.
Forward voltage groups are tested at a current pulse duration of 1 ms and a tolerance of $\pm 0.1\text{ V}$.

¹⁾ Durchlassspannungsgruppen
Forward voltage groups

Gruppe Group	Durchlassspannung Forward voltage		Einheit Unit
	min.	max.	
3A	1.90	2.05	V
3B	2.05	2.20	V
4A	2.20	2.35	V
4B	2.35	2.50	V

Helligkeits-Gruppierungsschema
Luminous Intensity Groups

Lichtgruppe Luminous Intensity Group	Lichtstärke Luminous Intensity I_V (mcd)	Lichtstrom Luminous Flux Φ_V (lm)
U2	560 ... 710	1900 (typ.)
V1	710 ... 900	2400 (typ.)
V2	900 ... 1120	3000 (typ.)
AA	1120 ... 1400	3750 (typ.)

Helligkeitswerte werden mit einer Stromeinprägungsdauer von 25 ms und einer Genauigkeit von ± 11 % ermittelt.
Luminous intensity is tested at a current pulse duration of 25 ms and a tolerance of ± 11 %.

Gruppenbezeichnung auf Etikett
Group Name on Label

Beispiel: U2-14A

Example: U2-14A

Lichtgruppe Luminous Intensity Group	Halbgruppe Half Group	Wellenlänge Wavelength	Durchlassspannung Forward Voltage
U	2	1	4A

Relative spektrale Emission $I_{rel} = f(\lambda)$, $T_A = 25\text{ °C}$, $I_F = 50\text{ mA}$

Relative Spectral Emission

$V(\lambda)$ = spektrale Augenempfindlichkeit

Standard eye response curve

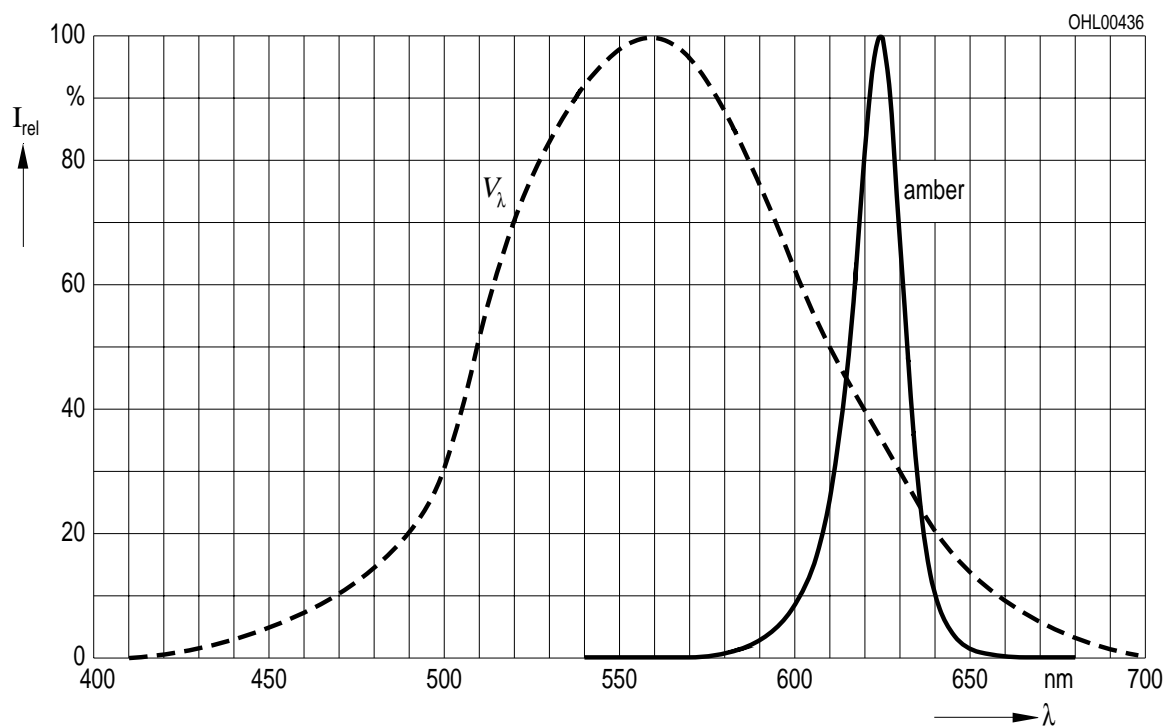

Abstrahlcharakteristik $I_{rel} = f(\varphi)$

Radiation Characteristic

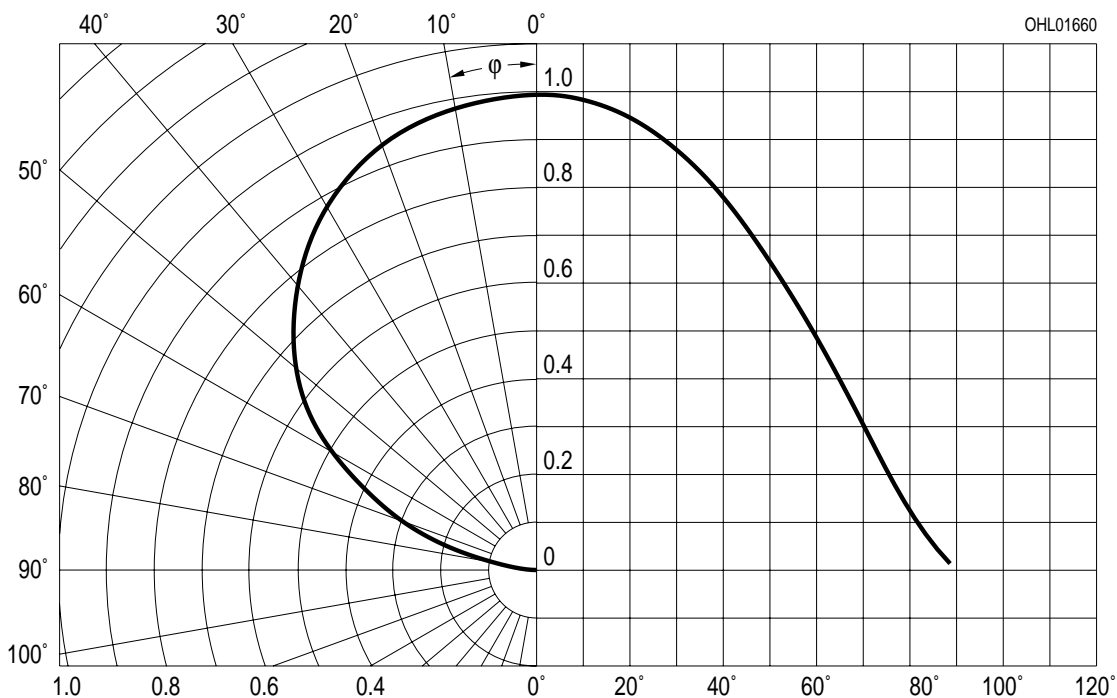

Durchlassstrom $I_F = f(V_F)$

Forward Current

$T_A = 25\text{ °C}$

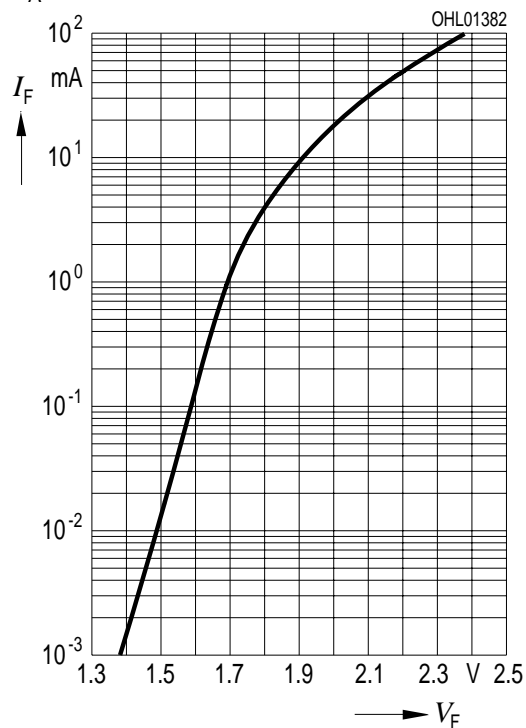

Relative Lichtstärke $I_V/I_{V(50\text{ mA})} = f(I_F)$

Relative Luminous Intensity

$T_A = 25\text{ °C}$

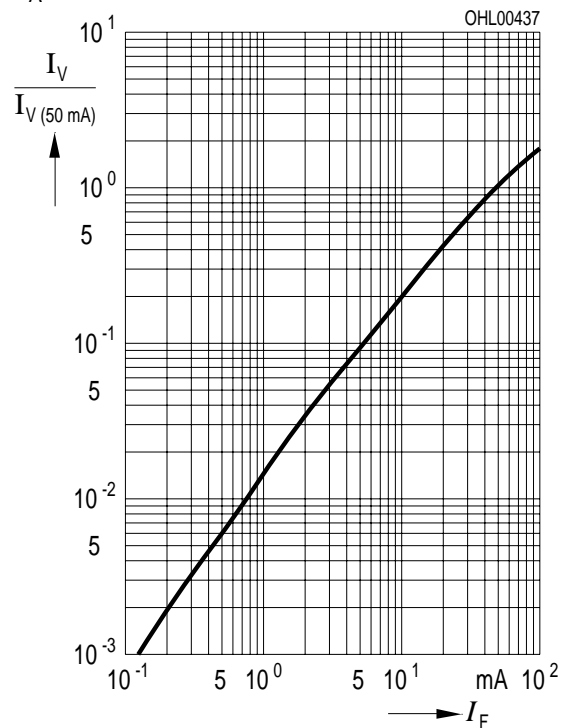

Maximal zulässiger Durchlassstrom $I_F = f(T)$

Max. Permissible Forward Current

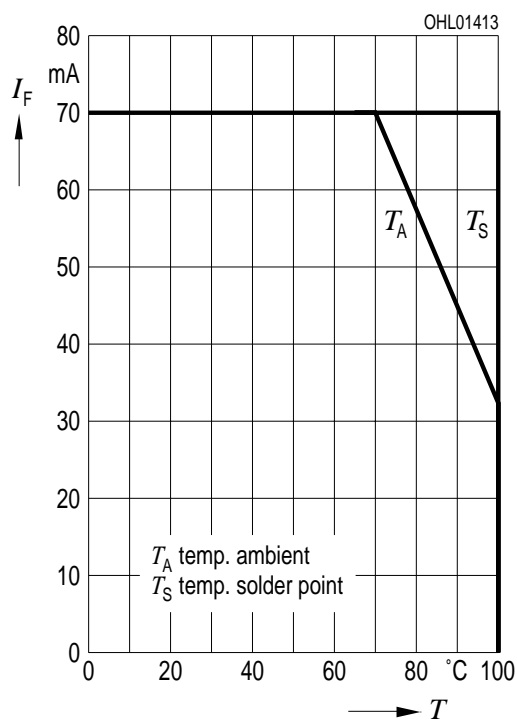

Relative Lichtstärke $I_V/I_{V(25\text{ °C})} = f(T_A)$

Relative Luminous Intensity

$I_F = 50\text{ mA}$

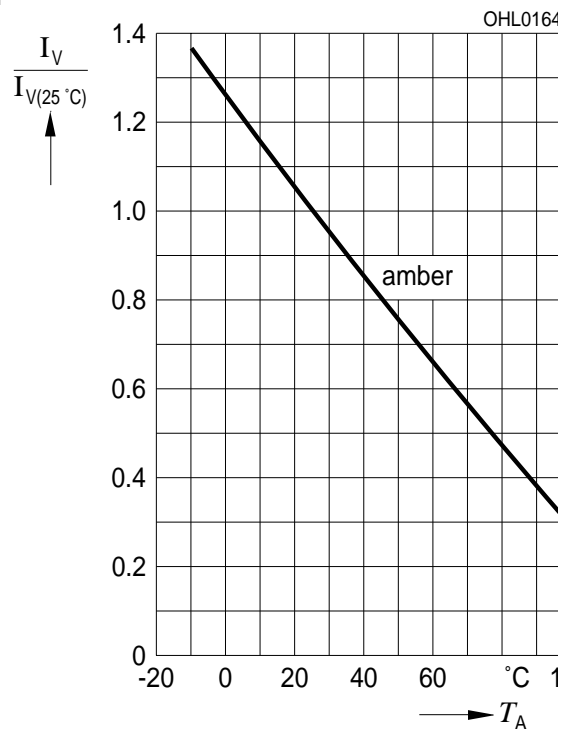

Zulässige Impulsbelastbarkeit $I_F = f(t_p)$
Permissible Pulse Handling Capability
 Duty cycle $D =$ parameter, $T_A = 25\text{ °C}$

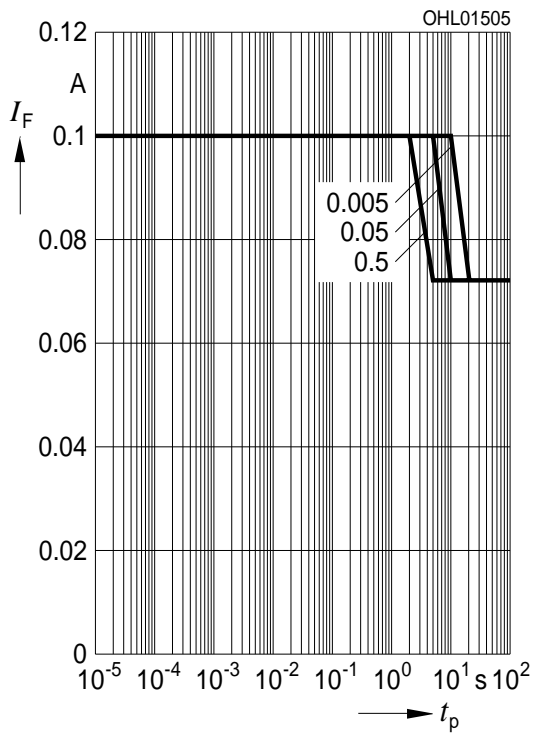

Zulässige Impulsbelastbarkeit $I_F = f(t_p)$
Permissible Pulse Handling Capability
 Duty cycle $D =$ parameter, $T_A = 85\text{ °C}$

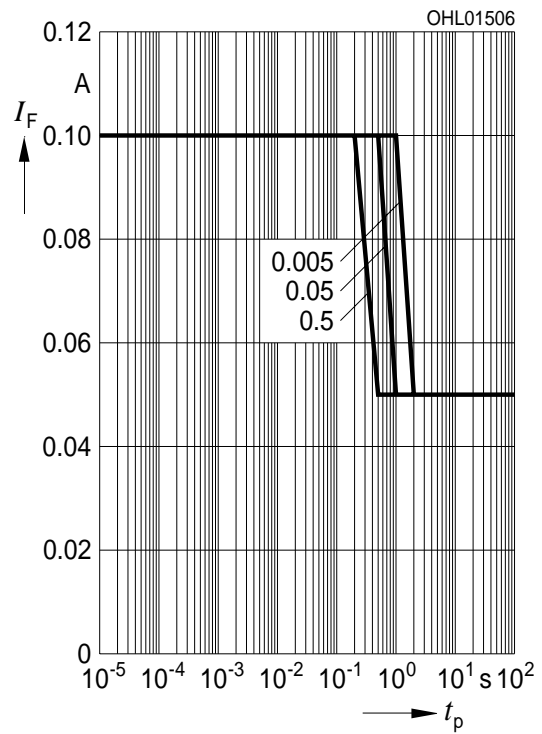

Maßzeichnung
Package Outlines

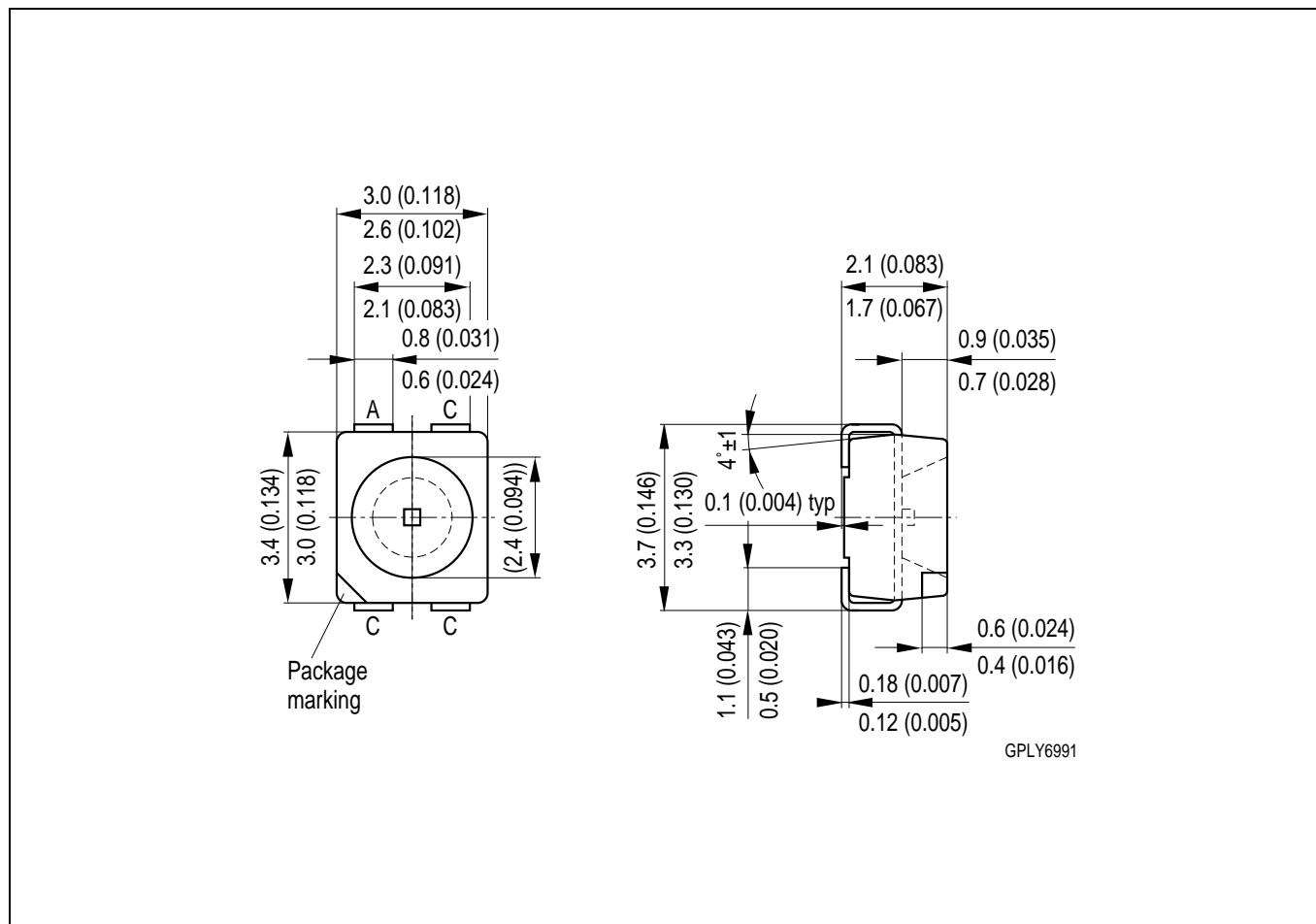

Maße werden wie folgt angegeben: mm (inch) / Dimensions are specified as follows: mm (inch).

Gewicht / Approx. weight: 31 mg

Lötbedingungen Vorbehandlung nach JEDEC Level 2
Soldering Conditions Preconditioning acc. to JEDEC Level 2

IR-Reflow Lötprofil (nach IPC 9501)
IR Reflow Soldering Profile (acc. to IPC 9501)

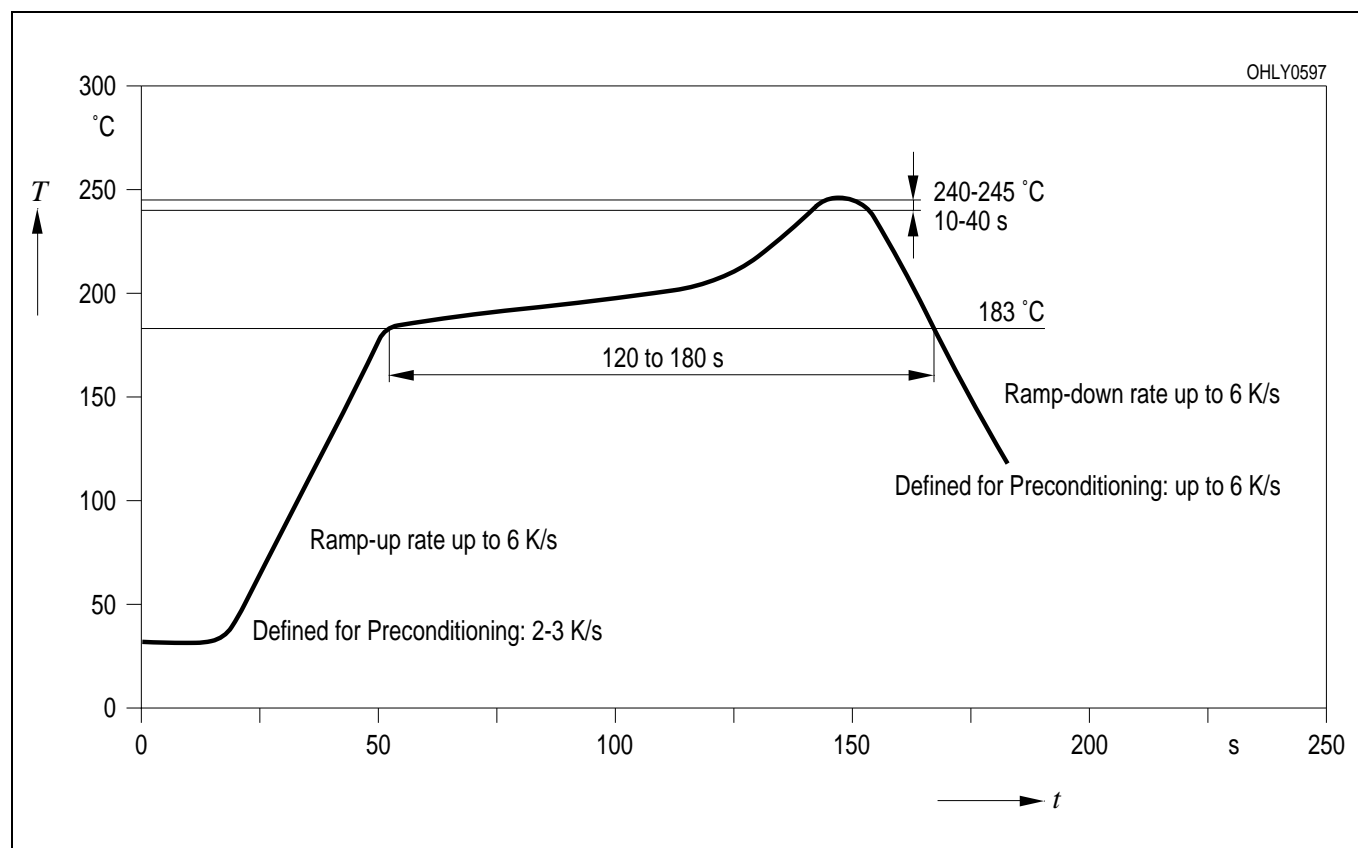

Wellenlötten (TTW) (nach CECC 00802)
TTW Soldering (acc. to CECC 00802)

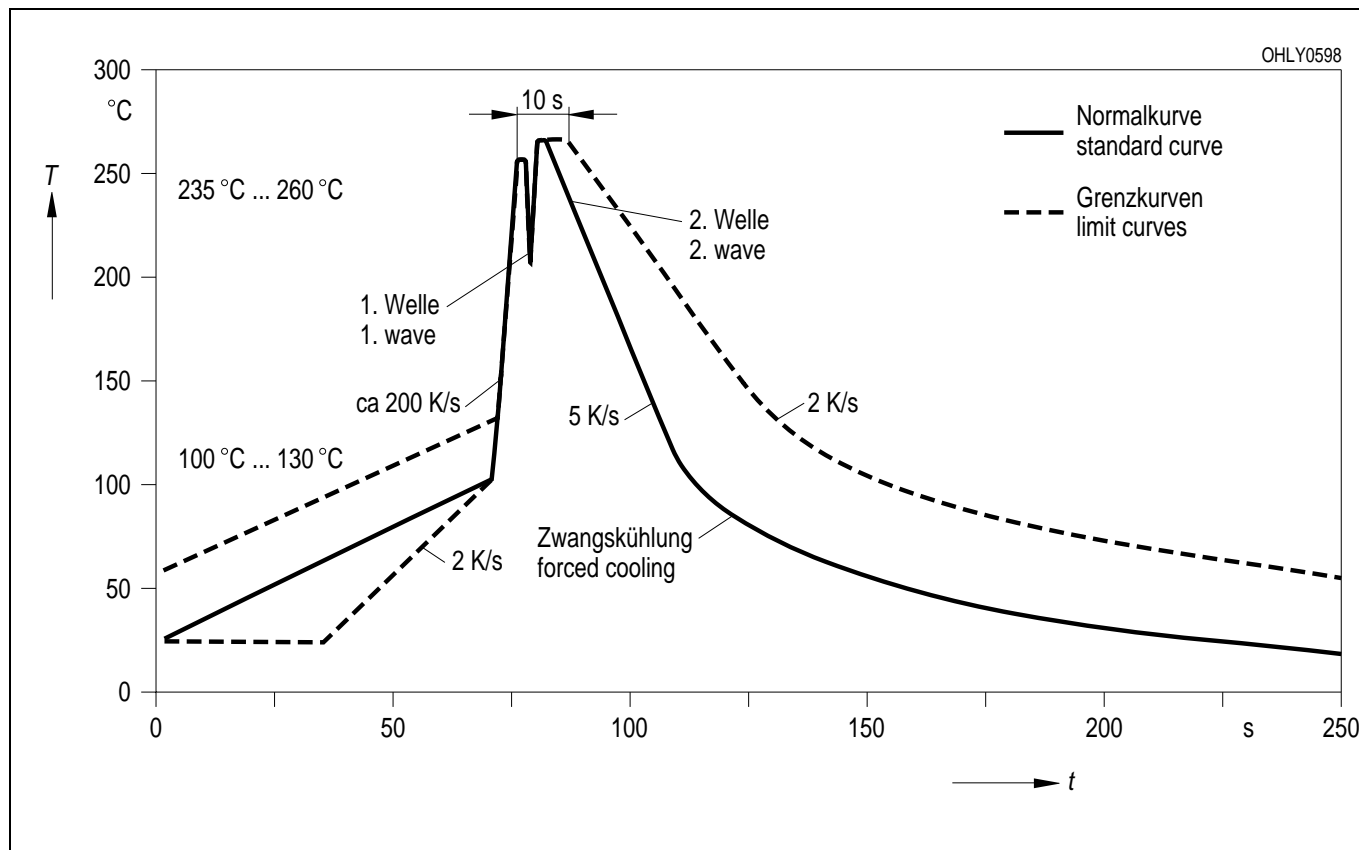

Empfohlenes Lötpad Design IR Reflow Löten
Recommended Solder Pad IR Reflow Soldering

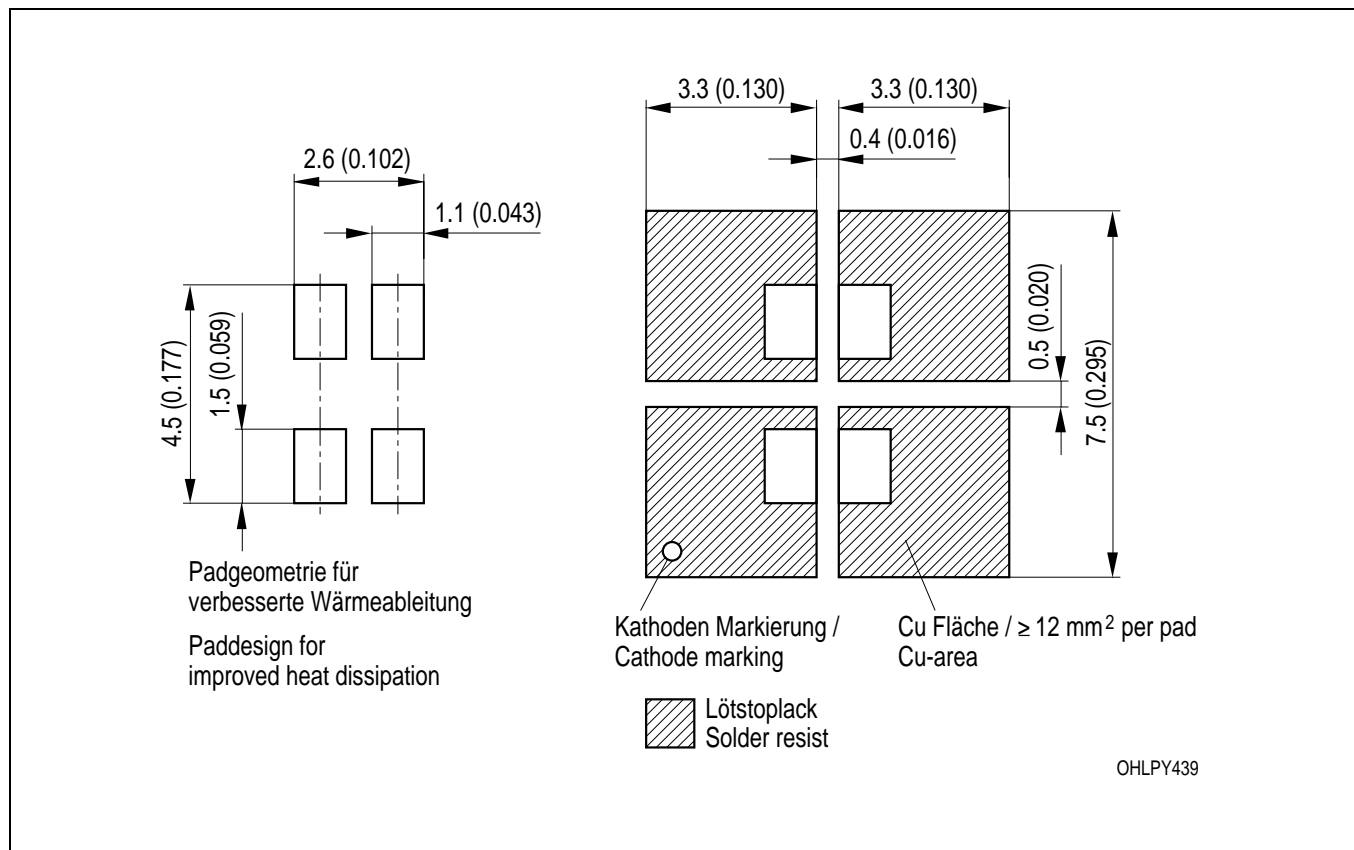

Maße werden wie folgt angegeben: mm (inch) / Dimensions are specified as follows: mm (inch).

Empfohlenes Lötpad Design Wellenlöten (TTW)
Recommended Solder Pad TTW Soldering

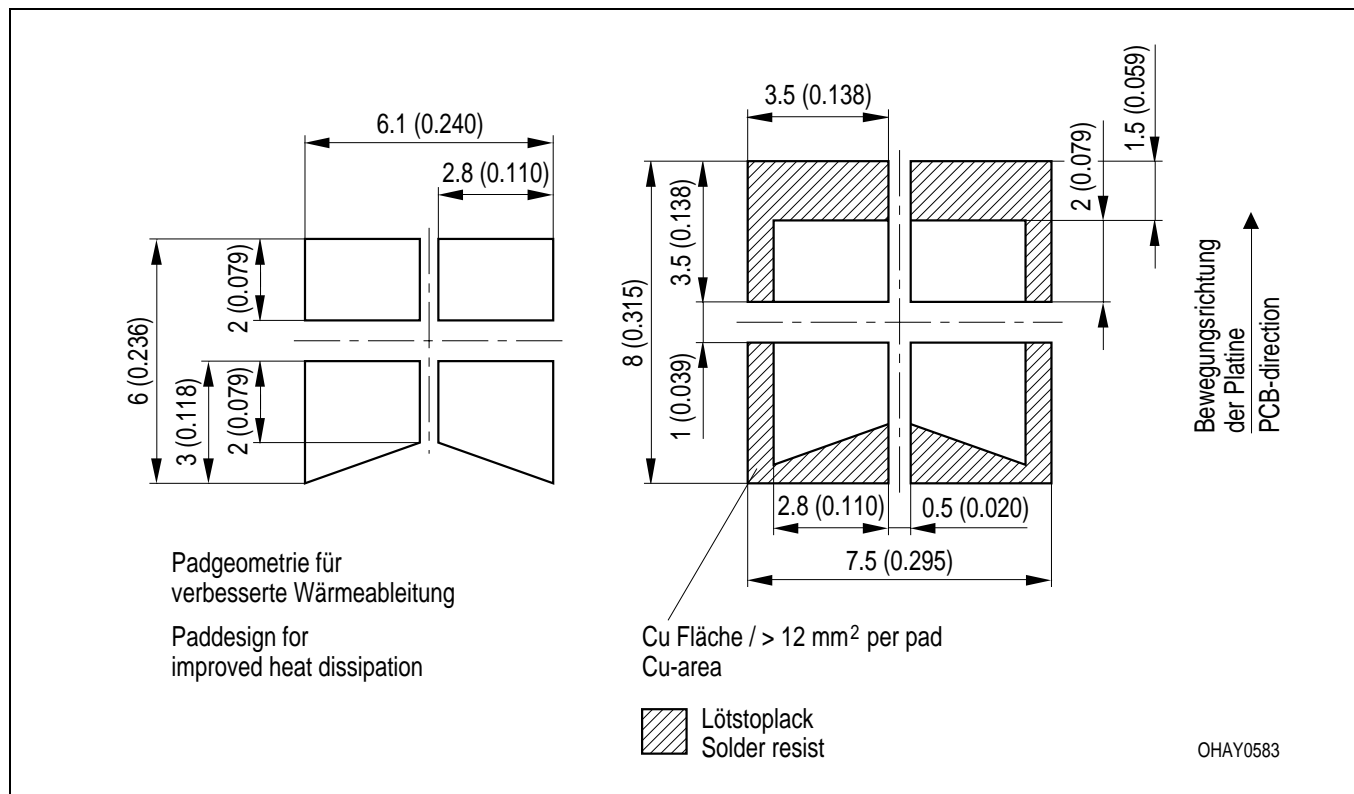

Maße werden wie folgt angegeben: mm (inch) / Dimensions are specified as follows: mm (inch).

Gurtung / Polarität und Lage

Verpackungseinheit 2000/Rolle, ø180 mm
 oder 8000/Rolle, ø330 mm

Method of Taping / Polarity and Orientation

Packing unit 2000/reel, ø180 mm
 or 8000/reel, ø330 mm

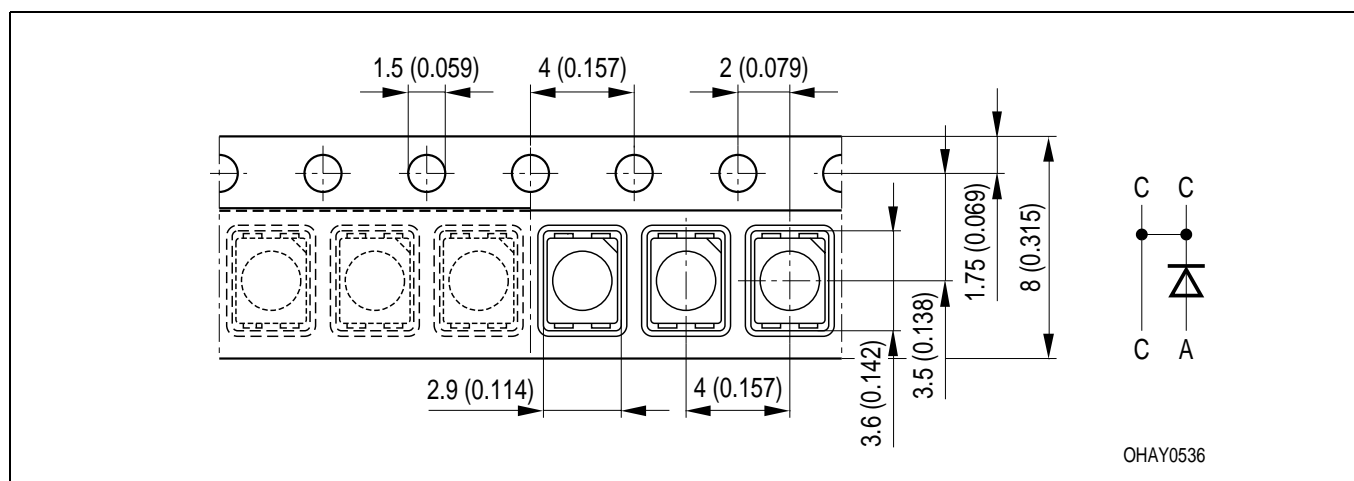

Maße werden wie folgt angegeben: mm (inch) / Dimensions are specified as follows: mm (inch).

Revision History: 2001-07-09

Previous Version: 2001-03-06

Page	Subjects (major changes since last revision)
2	Dimming range inserted

Published by OSRAM Opto Semiconductors GmbH & Co. OHG

Wernerwerkstrasse 2, D-93049 Regensburg

© All Rights Reserved.

Attention please!

The information describes the type of component and shall not be considered as assured characteristics.

Terms of delivery and rights to change design reserved. Due to technical requirements components may contain dangerous substances. For information on the types in question please contact our Sales Organization.

If printed or downloaded, please find the latest version in the Internet.

Packing

Please use the recycling operators known to you. We can also help you – get in touch with your nearest sales office. By agreement we will take packing material back, if it is sorted. You must bear the costs of transport. For packing material that is returned to us unsorted or which we are not obliged to accept, we shall have to invoice you for any costs incurred.

Components used in life-support devices or systems must be expressly authorized for such purpose! Critical components ¹ may only be used in life-support devices or systems ² with the express written approval of OSRAM OS.

¹ A critical component is a component used in a life-support device or system whose failure can reasonably be expected to cause the failure of that life-support device or system, or to affect its safety or the effectiveness of that device or system.

² Life support devices or systems are intended (a) to be implanted in the human body, or (b) to support and/or maintain and sustain human life. If they fail, it is reasonable to assume that the health of the user may be endangered.