

AlGaAs SPST Non-Reflective PIN Diode Switch

MA4AGSW1A
Rev 2.0

FEATURES

- Ultra Broad Bandwidth: 10 GHz to 50 GHz
- Functional Bandwidth: 100 MHz to 70 GHz
- 1.0 dB Insertion Loss, 35 dB Isolation at 50 GHz
- M/A-COM’s unique patent pending AlGaAs hetero-junction anode technology.
- Silicon Nitride Passivation
- Polymide Scratch protection

DESCRIPTION

M/A-COM’s MA4AGSW1A is an Aluminum-Gallium Arsenide anode enhanced, SPST Non-Reflective PIN diode switch. AlGaAs anodes, which utilize M/A-COM’s patent pending hetero-junction technology, produce less loss than conventional GaAs processes, by as much as a 0.3 dB reduction in insertion loss at 50 GHz. These devices are fabricated on a OMCVD eptaxial wafer using a process designed for high device uniformity and extremely low parasitics. The diodes themselves exhibit lower series resistance, lower capacitance, and faster switching speeds than Silicon based devices. They are fully passivated with silicon nitride and have an additional layer of a polymer for scratch protection. The protective coating prevents damage to the junction and the anode airbridges during handling. Off-chip bias circuitry is required and allows for maximum design flexibility.

APPLICATIONS

The output port of this device (J2), is 50 Ω terminated during Isolation mode, which allows this signal to be absorbed rather than reflected back. This functionality makes it ideal for instrumentation and radar applications. This absorptive switch can be added to available reflective AlGaAs switches to improve isolation VSWR and increase isolation magnitude.

The ultra low capacitance of the PIN diodes makes it ideal for usage in lower loss and higher isolation microwave and millimeter wave switch designs through 70 GHz. The lower series resistance of the AlGaAs diodes reduces the total insertion loss and distortion of the devices. These AlGaAs PIN switches are used as the switching arrays for radar systems, radiometers, and other multi-function components.

MA4AGSW1A LAYOUT

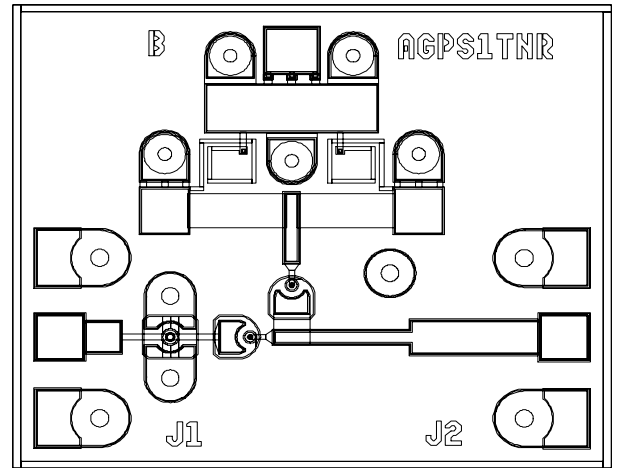

ABSOLUTE MAXIMUM RATINGS

@T_A = +25°C (Unless otherwise specified)

Parameter	MAXIMUM RATING
Operating Temperature	-55° TO +125°C
Storage Temperature	-65°C TO +150°C
Junction Temperature	+175°C
Assembly Temperature	+300°C for < 10 sec
Incident C.W. RF Power	+23 dBm C.W.
Reverse Voltage	- 25 V
Forward Bias Current	+/-25 mA

Note: Exceeding ANY of these values may result in permanent damage

**Maximum Operating Conditions for Combination of RF Power, D.C. Bias, and Temperature:
+ 23 dBm C.W. @ 10 mA (per Diode) @ + 85 °C.**

Electrical Specifications @ 25 ° C (On Wafer Measurements)

Frequency Range = 10 – 50 GHz				
Parameter	Ports	Bias Conditions	Specification	Comments
Insertion Loss	J1 – J2	D.C. Bias 1 = -1.35 V @ -10 mA D.C. Bias B = -1.35 V @ 0 mA	1.2 dB Typical	Value at 50 GHz
Input Return Loss	J1 (Terminate J2 into 50Ω)	D.C. Bias 1 = -1.35 V @ -10 mA D.C. Bias B = -1.35 V @ 0 mA	15 dB Typical	Value at 50 GHz In Insertion Loss State
Output Return Loss (Insertion Loss)	J2 (Terminate J1 into 50Ω)	D.C. Bias 1 = -1.35 V @ -10 mA D.C. Bias B = -1.35 V @ 0 mA	18 dB Typical	Value at 50 GHz In Insertion Loss State
Output Return Loss (Isolation)	J2	D.C. Bias 1 = +1.35 V @ +10 mA D.C. Bias B = +1.35 V @ +10 mA	18 dB Typical	Value at 50 GHz In Isolation State
Isolation	J1 – J2	D.C. Bias 1 = +1.35 V @ +10 mA D.C. Bias B = +1.35 V @ +10 mA	30 dB Typical	Value at 50 GHz
Switching Speed (10 % - 90 % RF Voltage)	J1 – J2	+/- 5V PIN Diode TTL Driver @ 1 MHz Rep Rate	10 nS Typical	Value at 10 GHz

Notes:

1. “ D.C. Bias 1 ” and “ D.C. Bias B ” Nodes can be connected together.

Error!

Typical Performance (On Wafer Measurements)

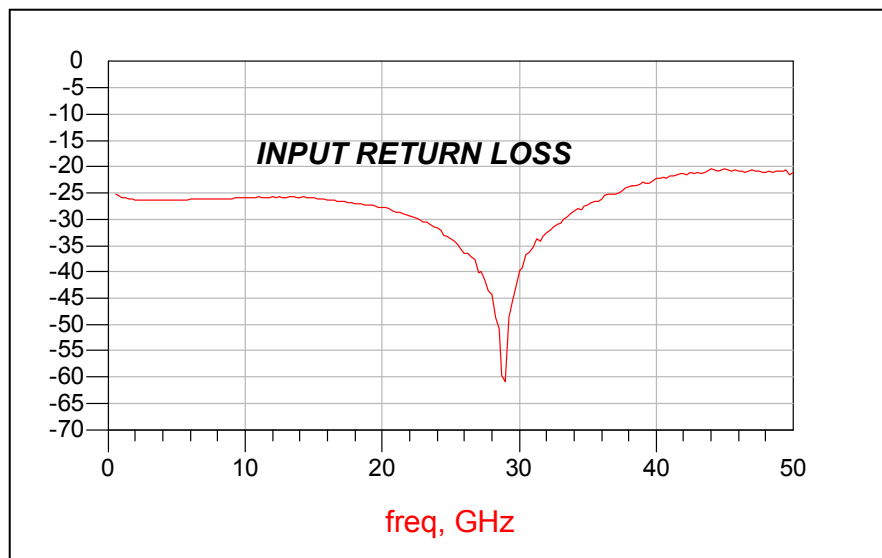
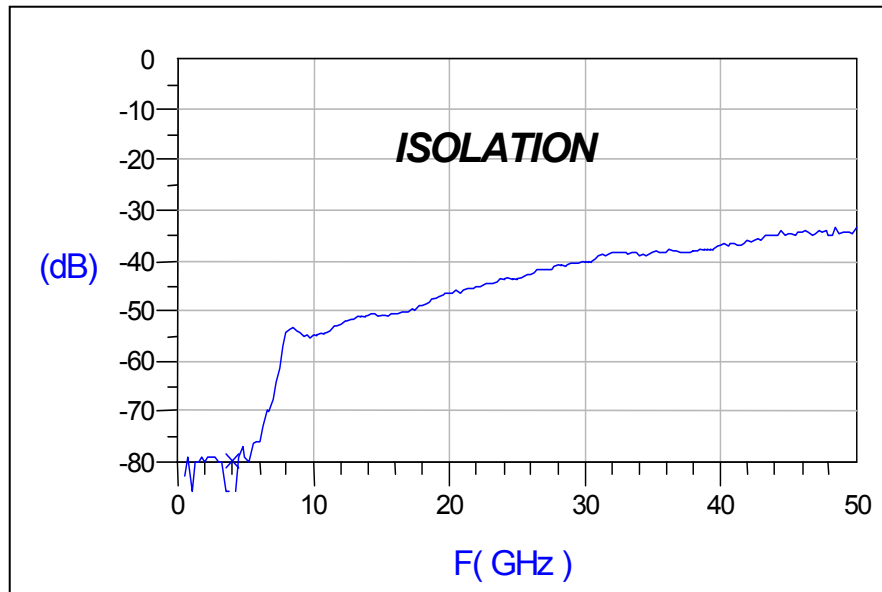

Typical Performance (On Wafer Measurements)

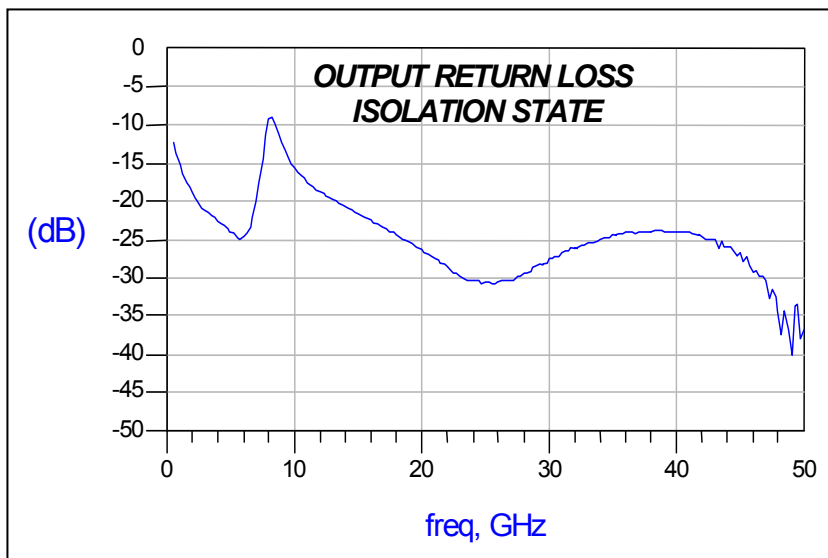
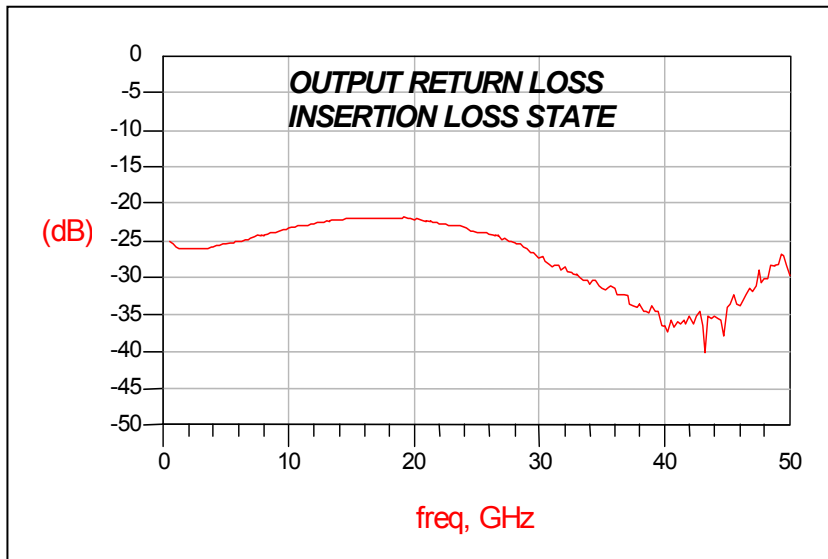

Outline Dimensions

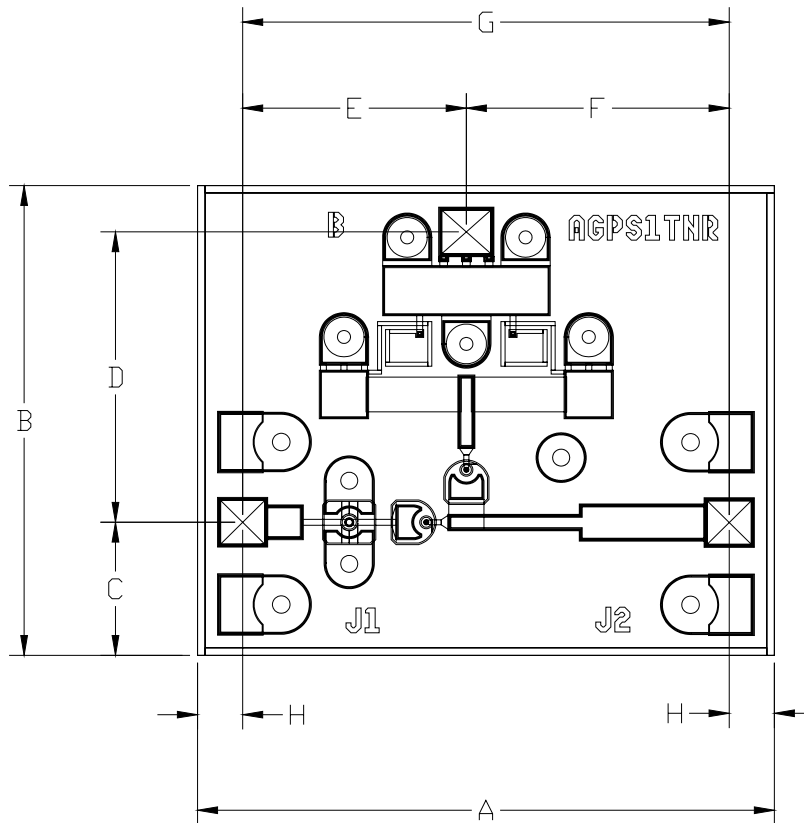

Dimensions				
	mm		mils	
	min	max	min	max
A	1.14	1.19	44.9	46.9
B	0.94	0.99	36.9	38.9
C	0.26	0.29	10.4	11.4
D	0.58	0.59	22.8	23.4
E	0.44	0.45	17.3	17.9
F	0.52	0.53	20.3	20.9
G	0.96	0.98	37.9	38.5
H	0.09	0.11	3.4	4.4
Thickness	0.09	0.11	3.5	4.5

ASSEMBLY INSTRUCTIONS

The following precautions should be observed to avoid damaging these chips.

CLEANLINESS

These chips should be handled in a clean environment. Clean die after solder die attach installation with care.

STATIC SENSITIVITY

These Devices are considered ESD Class1. Proper ESD techniques should be used when handling these devices.

GENERAL HANDLING

The protective polymer coating on the active areas of these die provides scratch and impact protection, particularly for the metal air bridge, which contacts the diode's anode. Die should primarily be handled with vacuum pickups, or alternatively with plastic tweezers.

MOUNTING TECHNIQUES

These AlGaAs devices are designed to be mounted with electrically conductive silver epoxy or with a solder that does not excessively scavenge gold.

SOLDER DIE ATTACH

All die attach and bonding methods should be compatible with gold metal. Solders which do not excessively scavenge gold, such as 80Au/20Sn or Sn62/Pb36/Ag2 are acceptable for usage. Do not expose die to a temperature greater than 300 °C for more than 10 seconds.

ELECTRICAL CONDUCTIVE EPOXY DIE ATTACH

Assembly can be preheated to approximately 125°C. Use a controlled thickness of approximately 2 mils for best electrical and thermal conductivity. Cure epoxy as per manufacturer's schedule. For extended cure times, temperatures should be kept below 150°C.

RIBBON/WIRE BONDING

Wedge thermo compression bonding or ball bonding may be used to attach gold ribbons or gold wires to bonding pads. 1 Mil diameter gold wire or 1/4 x 3 mil sq. gold ribbons should be used for all RF ports for lower inductance and best mmwave performance.

Successful Operation of the MA4AGSW1A Switch

One External Bias Network and One External D.C Return is required for successful operation of the MA4AGSW1A Absorptive SPST AlGaAs PIN Diode Switch. The Backside Area of the Die is the RF and D.C. Return Ground Plane. In the Low Loss State, the Series Diode is Forward Biased with -1.35V, - 10 mA, at " D.C. Bias 1 " and the Match Diode is Reverse Biased at -1.35V, 0 mA at " D.C. Bias B ". In the Isolation State, both the Shunt Diode and the Match Diode are Both Forward Biased at + 1.35 V, + 10 mA at " D.C. Bias 1" and " D.C. Bias B ". This Isolation State condition makes the Series Diode Reverse Biased by 1.35V. This Isolation State Results in a Good 50 Ω Match into Port J2 Only. The RF to D.C. Bias Truth table is shown in Table I. The Bias Network Design should yield > 30 dB RF to DC Isolation.

MA4AGSW1A Schematic for 10 – 30 GHz Operation

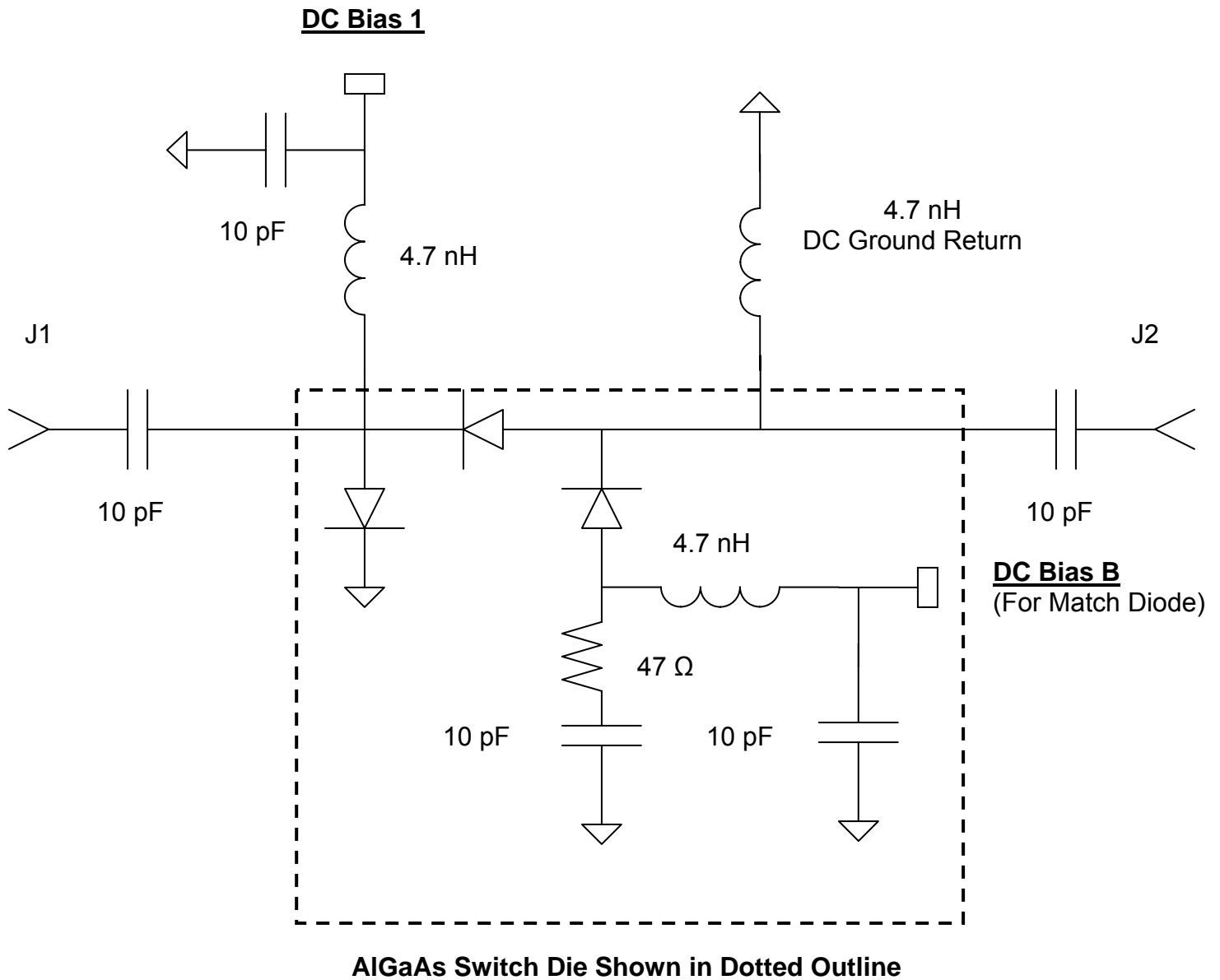

Notes:

1. “ D.C. Bias 1” and “ D.C. Bias B ” Nodes can be connected together.
2. Diode Junction Forward Bias Voltage, $\Delta V_f @ 10 \text{ mA} \sim 1.35 \text{ V} @ + 25^\circ \text{ C}$.

Table I: D.C. to RF Truth Table

J1-J2 Low Loss : Good VSWR at J1 & J2	J1-J2 Isolation : Good VSWR at J2
D.C. Bias 1 = -1.35V @ - 10mA	D.C. Bias 1 = + 1.35V @ + 10mA
D.C. Bias B = -1.35V @ 0mA	D.C. Bias B = + 1.35V @ + 10mA

On Wafer S Parameters @ + 25C

Insertion Loss State

F (GHz)	S11 Mag	S11 Ang	S21 Mag	S21 Ang	S12 Mag	S12Ang	S22 Mag	S22 Ang
.500	.05547	-14.13	.94244	-1.66	.94244	-1.66	.05571	-15.03
.750	.05276	-15.15	.94469	-2.85	.94469	-2.85	.05296	-16.45
1.000	.05100	-16.32	.94581	-4.01	.94582	-4.01	.05141	-18.07
1.250	.05002	-17.71	.94690	-5.15	.94690	-5.15	.05052	-19.73
1.500	.04930	-18.98	.94720	-6.30	.94719	-6.30	.04990	-21.64
1.750	.04888	-20.46	.94743	-7.42	.94744	-7.42	.04960	-23.41
2.000	.04855	-22.18	.94773	-8.55	.94772	-8.55	.04940	-25.51
2.250	.04825	-23.61	.94770	-9.68	.94770	-9.68	.04939	-27.46
2.500	.04819	-25.59	.94781	-10.79	.94781	-10.79	.04944	-29.45
2.750	.04803	-27.32	.94767	-11.90	.94768	-11.90	.04950	-31.40
3.000	.04786	-29.12	.94768	-13.02	.94769	-13.02	.04991	-33.36
3.250	.04767	-30.73	.94749	-14.13	.94749	-14.13	.05019	-35.62
3.500	.04780	-32.68	.94759	-15.23	.94759	-15.23	.05041	-37.75
3.750	.04775	-34.70	.94733	-16.34	.94734	-16.34	.05081	-39.42
4.000	.04771	-36.36	.94719	-17.46	.94720	-17.46	.05130	-41.80
4.250	.04775	-38.07	.94687	-18.55	.94688	-18.55	.05170	-43.92
4.500	.04777	-40.07	.94680	-19.65	.94679	-19.65	.05213	-45.94
4.750	.04779	-41.76	.94672	-20.75	.94673	-20.75	.05279	-48.04
5.000	.04795	-43.78	.94649	-21.85	.94650	-21.85	.05339	-50.25
5.250	.04800	-45.67	.94607	-22.96	.94607	-22.96	.05397	-52.34
5.500	.04830	-47.51	.94580	-24.07	.94579	-24.07	.05437	-54.42
5.750	.04842	-49.57	.94552	-25.16	.94552	-25.16	.05496	-56.37
6.000	.04862	-51.49	.94528	-26.26	.94527	-26.26	.05553	-58.29
6.250	.04876	-53.47	.94492	-27.36	.94492	-27.36	.05626	-60.29
6.500	.04906	-55.55	.94469	-28.46	.94469	-28.46	.05698	-62.30
6.750	.04918	-57.56	.94413	-29.55	.94412	-29.55	.05763	-64.01
7.000	.04936	-59.68	.94366	-30.65	.94367	-30.65	.05854	-66.06
7.250	.04956	-61.79	.94320	-31.74	.94320	-31.74	.05933	-68.16
7.500	.04980	-64.04	.94284	-32.84	.94283	-32.84	.06000	-70.19
7.750	.04953	-66.39	.94217	-33.93	.94217	-33.93	.06059	-72.19
8.000	.04910	-67.89	.94164	-34.98	.94164	-34.98	.06070	-74.05
8.250	.04936	-69.47	.94176	-36.06	.94177	-36.06	.06165	-75.54
8.500	.04995	-71.42	.94211	-37.14	.94211	-37.14	.06272	-77.49
8.750	.04988	-73.21	.94174	-38.24	.94175	-38.24	.06383	-79.06
9.000	.04991	-75.30	.94134	-39.34	.94133	-39.34	.06463	-80.92
9.250	.05047	-77.42	.94082	-40.44	.94081	-40.44	.06529	-83.14
9.500	.05039	-79.49	.94076	-41.53	.94077	-41.53	.06640	-84.75
9.750	.05091	-81.50	.94036	-42.62	.94037	-42.62	.06683	-86.86
10.000	.05083	-83.80	.93997	-43.71	.93998	-43.71	.06757	-88.54
10.250	.05091	-85.51	.93996	-44.79	.93996	-44.79	.06853	-90.45
10.500	.05114	-87.75	.93919	-45.89	.93920	-45.89	.06922	-92.47
10.750	.05090	-90.05	.93895	-46.97	.93896	-46.97	.07012	-94.37
11.000	.05120	-91.94	.93842	-48.06	.93842	-48.06	.07083	-95.91
11.250	.05099	-93.81	.93822	-49.15	.93821	-49.15	.07141	-97.43
11.500	.05116	-95.76	.93787	-50.23	.93788	-50.23	.07227	-99.34
11.750	.05101	-97.99	.93732	-51.32	.93733	-51.32	.07270	-101.21
12.000	.05121	-99.58	.93730	-52.41	.93729	-52.41	.07350	-102.81
12.250	.05107	-102.22	.93689	-53.49	.93688	-53.49	.07417	-104.59
12.500	.05127	-103.70	.93650	-54.58	.93651	-54.58	.07473	-106.64
12.750	.05104	-105.60	.93619	-55.67	.93619	-55.67	.07532	-107.89
13.000	.05098	-107.69	.93575	-56.76	.93575	-56.76	.07567	-109.84
13.250	.05126	-109.70	.93536	-57.84	.93536	-57.84	.07633	-111.50
13.500	.05122	-111.78	.93501	-58.93	.93501	-58.93	.07685	-113.29
13.750	.05090	-113.66	.93469	-60.01	.93469	-60.01	.07730	-114.82
14.000	.05101	-115.78	.93426	-61.11	.93426	-61.11	.07754	-116.72

14.250	.05135	-117.82	.93360	-62.18	.93361	-62.18	.07818	-118.39
14.500	.05072	-119.86	.93268	-63.26	.93268	-63.26	.07866	-120.21
14.750	.05029	-122.22	.93219	-64.35	.93219	-64.35	.07842	-121.93
15.000	.05035	-123.94	.93205	-65.41	.93205	-65.41	.07873	-123.48
15.250	.04974	-126.15	.93161	-66.44	.93160	-66.44	.07886	-125.02
15.500	.04930	-127.96	.93136	-67.53	.93136	-67.53	.07885	-126.75
15.750	.04890	-129.91	.93060	-68.61	.93061	-68.61	.07905	-128.27
16.000	.04828	-132.57	.93060	-69.71	.93060	-69.71	.07913	-130.07
16.250	.04781	-133.30	.93115	-70.77	.93114	-70.77	.07898	-131.09
16.500	.04747	-135.09	.93082	-71.82	.93083	-71.82	.07911	-132.44
16.750	.04722	-137.29	.93002	-72.89	.93002	-72.89	.07899	-133.80
17.000	.04648	-138.80	.92938	-74.00	.92939	-74.00	.07907	-135.59
17.250	.04615	-140.25	.92975	-75.09	.92975	-75.09	.07920	-136.98
17.500	.04579	-142.31	.92939	-76.13	.92940	-76.13	.07901	-138.57
17.750	.04510	-144.14	.92954	-77.22	.92955	-77.22	.07954	-139.88
18.000	.04494	-145.56	.92922	-78.30	.92922	-78.30	.07864	-141.39
18.250	.04381	-146.84	.92860	-79.33	.92861	-79.33	.07887	-142.22
18.500	.04408	-148.73	.92854	-80.45	.92854	-80.45	.07894	-143.32
18.750	.04302	-149.07	.92959	-81.51	.92960	-81.51	.07949	-144.35
19.000	.04367	-151.64	.92987	-82.62	.92987	-82.62	.07949	-146.12
19.250	.04322	-153.43	.92969	-83.72	.92970	-83.72	.07988	-147.83
19.500	.04224	-155.94	.92920	-84.83	.92920	-84.83	.07948	-149.96
19.750	.04122	-157.50	.92851	-85.90	.92850	-85.90	.07878	-150.95
20.000	.04047	-159.50	.92738	-87.00	.92738	-87.00	.07820	-152.52
20.250	.04126	-160.65	.92871	-88.13	.92870	-88.12	.07894	-153.62
20.500	.03950	-163.02	.92780	-89.17	.92781	-89.17	.07713	-155.37
20.750	.03792	-164.93	.92768	-90.23	.92769	-90.23	.07648	-156.95
21.000	.03703	-166.23	.92743	-91.32	.92743	-91.32	.07545	-157.55
21.250	.03687	-169.11	.92745	-92.46	.92745	-92.46	.07632	-159.61
21.500	.03612	-169.75	.92707	-93.55	.92707	-93.55	.07497	-160.38
21.750	.03469	-171.50	.92661	-94.69	.92661	-94.69	.07506	-161.96
22.000	.03388	-174.32	.92657	-95.70	.92658	-95.70	.07343	-162.86
22.250	.03278	-173.13	.92540	-96.84	.92540	-96.84	.07269	-164.03
22.500	.03246	-175.92	.92512	-97.90	.92513	-97.90	.07269	-165.49
22.750	.03116	-177.64	.92558	-98.98	.92559	-98.98	.07197	-166.52
23.000	.03004	-179.26	.92554	-100.10	.92554	-100.10	.07171	-167.65
23.250	.02936	-179.07	.92572	-101.18	.92572	-101.18	.07092	-168.56
23.500	.02813	178.58	.92534	-102.23	.92533	-102.23	.07046	-169.57
23.750	.02676	177.73	.92584	-103.35	.92584	-103.35	.07063	-170.54
24.000	.02586	172.53	.92492	-104.46	.92493	-104.46	.06864	-173.06
24.250	.02491	169.29	.92445	-105.59	.92445	-105.59	.06737	-174.15
24.500	.02221	169.87	.92442	-106.64	.92441	-106.64	.06523	-174.92
24.750	.02164	171.46	.92422	-107.72	.92421	-107.72	.06536	-175.12
25.000	.02067	170.82	.92467	-108.80	.92467	-108.80	.06414	-176.00
25.250	.01930	168.87	.92409	-109.92	.92409	-109.92	.06410	-176.35
25.500	.01809	166.52	.92325	-111.04	.92324	-111.04	.06310	-178.70
25.750	.01662	171.49	.92352	-112.07	.92351	-112.07	.06255	-177.66
26.000	.01508	167.27	.92416	-113.17	.92415	-113.17	.06155	179.99
26.250	.01486	168.72	.92389	-114.35	.92389	-114.35	.06101	-179.71
26.500	.01374	165.44	.92325	-115.43	.92326	-115.43	.06032	178.10
26.750	.01327	161.55	.92271	-116.55	.92270	-116.55	.06022	177.13
27.000	.00979	162.46	.92142	-117.60	.92142	-117.60	.05732	175.28
27.250	.01014	163.35	.92217	-118.67	.92217	-118.67	.05831	175.01
27.500	.00830	159.53	.92256	-119.74	.92255	-119.74	.05557	174.44
27.750	.00664	160.87	.92300	-120.89	.92301	-120.89	.05575	173.51
28.000	.00614	168.15	.92190	-122.01	.92191	-122.01	.05387	172.52
28.250	.00363	-173.81	.92131	-123.10	.92131	-123.10	.05308	172.00
28.500	.00288	148.73	.92179	-124.19	.92179	-124.19	.05272	170.13
28.750	.00104	-145.83	.92134	-125.32	.92133	-125.32	.05077	170.32
29.000	.00090	1.99	.92106	-126.43	.92107	-126.43	.04922	169.01
29.250	.00364	-45.19	.92065	-127.54	.92065	-127.54	.04685	169.74
29.500	.00534	-33.10	.92099	-128.60	.92099	-128.60	.04639	167.93

29.750	.00737	-52.54	.92025	-129.75	.92026	-129.75	.04480	167.59
30.000	.01042	-51.45	.92005	-130.85	.92005	-130.85	.04220	168.67
30.250	.01103	-52.47	.92037	-131.95	.92037	-131.95	.04379	166.90
30.500	.01450	-52.20	.92014	-133.06	.92015	-133.06	.04087	166.79
30.750	.01526	-57.64	.92000	-134.19	.92000	-134.19	.03937	169.08
31.000	.01702	-56.76	.91895	-135.35	.91895	-135.35	.03727	169.08
31.250	.02046	-61.02	.91790	-136.44	.91789	-136.44	.03743	172.14
31.500	.01941	-62.63	.91781	-137.46	.91780	-137.46	.03766	168.38
31.750	.02183	-61.74	.91763	-138.58	.91762	-138.58	.03553	170.71
32.000	.02358	-66.97	.91603	-139.56	.91603	-139.56	.03689	172.52
32.250	.02454	-66.70	.91628	-140.72	.91627	-140.72	.03503	168.60
32.500	.02649	-67.85	.91614	-141.86	.91613	-141.86	.03401	168.85
32.750	.02845	-68.93	.91586	-143.00	.91587	-143.00	.03306	169.13
33.000	.02925	-69.39	.91522	-144.06	.91522	-144.06	.03295	170.81
33.250	.03109	-71.49	.91516	-145.12	.91516	-145.12	.03197	170.08
33.500	.03280	-71.36	.91552	-146.22	.91552	-146.22	.03049	171.26
33.750	.03564	-71.29	.91549	-147.41	.91549	-147.41	.03001	172.88
34.000	.03820	-72.84	.91592	-148.40	.91592	-148.40	.02857	175.60
34.250	.03999	-78.19	.91495	-149.59	.91495	-149.59	.03042	177.15
34.500	.03937	-79.44	.91481	-150.59	.91480	-150.59	.03005	174.66
34.750	.04189	-78.53	.91594	-151.75	.91594	-151.75	.02800	174.69
35.000	.04353	-80.36	.91578	-152.93	.91578	-152.93	.02671	178.53
35.250	.04579	-82.73	.91494	-154.03	.91494	-154.03	.02576	178.82
35.500	.04682	-84.78	.91425	-155.10	.91426	-155.10	.02709	-179.94
35.750	.04622	-85.88	.91384	-156.14	.91384	-156.14	.02797	176.67
36.000	.04971	-85.18	.91378	-157.41	.91379	-157.41	.02629	-179.71
36.250	.05284	-86.30	.91517	-158.53	.91518	-158.53	.02420	-179.98
36.500	.05429	-88.89	.91179	-159.57	.91178	-159.57	.02438	-178.91
36.750	.05450	-92.31	.91307	-160.59	.91306	-160.59	.02442	175.95
37.000	.05468	-93.14	.91358	-161.62	.91358	-161.62	.02367	172.97
37.250	.05675	-91.05	.91425	-162.80	.91424	-162.80	.02107	178.53
37.500	.05972	-91.65	.91401	-164.02	.91402	-164.02	.02010	-179.72
37.750	.06328	-93.85	.91361	-165.17	.91360	-165.17	.01992	-176.77
38.000	.06425	-95.80	.91331	-166.23	.91331	-166.23	.02110	-175.82
38.250	.06571	-97.91	.91227	-167.29	.91228	-167.29	.01840	-170.91
38.500	.06627	-99.92	.91261	-168.50	.91261	-168.50	.01839	-162.74
38.750	.06823	-99.92	.91327	-169.67	.91327	-169.67	.01795	-163.97
39.000	.07049	-102.45	.91155	-170.75	.91154	-170.75	.02028	-160.62
39.250	.06891	-104.42	.91182	-171.75	.91183	-171.75	.01833	-170.43
39.500	.06953	-103.43	.91175	-172.89	.91174	-172.89	.01890	-165.72
39.750	.07356	-105.61	.91138	-174.07	.91139	-174.07	.01488	-163.30
40.000	.07811	-106.97	.91226	-175.31	.91227	-175.31	.01488	-153.47
40.250	.07747	-110.27	.91134	-176.38	.91134	-176.38	.01367	-159.72
40.500	.07912	-111.07	.91039	-177.51	.91040	-177.51	.01613	-146.34
40.750	.07739	-112.63	.90898	-178.48	.90898	-178.48	.01441	-143.62
41.000	.08135	-114.01	.90813	-179.74	.90814	-179.74	.01596	-137.37
41.250	.08198	-113.58	.90898	179.10	.90898	179.10	.01515	-141.38
41.500	.08473	-115.16	.90999	177.88	.90999	177.88	.01635	-125.93
41.750	.08513	-118.56	.90805	176.90	.90805	176.90	.01530	-129.70
42.000	.08704	-119.99	.90639	175.79	.90638	175.79	.01727	-128.37
42.250	.08470	-121.72	.90599	174.71	.90599	174.71	.01530	-130.53
42.500	.08776	-121.37	.90755	173.30	.90754	173.30	.01724	-119.61
42.750	.08662	-123.61	.90748	172.25	.90747	172.25	.01830	-127.00
43.000	.08853	-124.91	.90686	171.11	.90686	171.11	.01497	-120.81
43.250	.08671	-126.34	.90481	170.17	.90482	170.17	.00973	-130.14
43.500	.08882	-129.64	.90477	169.05	.90477	169.05	.01745	-119.89
43.750	.09094	-132.31	.90554	167.87	.90554	167.87	.01670	-120.93
44.000	.09485	-131.16	.90269	166.59	.90269	166.59	.01727	-108.56
44.250	.09330	-134.10	.90349	165.59	.90349	165.59	.01690	-104.18
44.500	.09103	-135.89	.90163	164.52	.90164	164.52	.01619	-102.26
44.750	.09222	-138.67	.90045	163.42	.90045	163.42	.01282	-94.74
45.000	.09507	-139.16	.89873	162.31	.89872	162.31	.01968	-94.77

AlGaAs SPST Non-Reflective PIN Diode Switch

MA4AGSW1A

Rev 2.0

45.250	.09349	-141.00	.89982	161.16	.89983	161.16	.02088	-86.34
45.500	.09172	-139.48	.90057	160.09	.90057	160.09	.02429	-88.17
45.750	.09272	-141.90	.89873	158.89	.89873	158.89	.02057	-86.38
46.000	.09182	-145.28	.89885	157.89	.89884	157.89	.02037	-77.52
46.250	.09127	-145.01	.89855	156.77	.89855	156.77	.02217	-87.65
46.500	.08861	-145.45	.90021	155.64	.90020	155.64	.02469	-82.06
46.750	.09153	-146.93	.89816	154.44	.89817	154.44	.02642	-77.57
47.000	.09193	-148.69	.89791	153.49	.89791	153.49	.02526	-72.32
47.250	.09059	-150.41	.89818	152.43	.89818	152.43	.02790	-69.92
47.500	.08933	-153.02	.89471	151.28	.89471	151.28	.03564	-75.22
47.750	.08815	-152.11	.89924	150.14	.89924	150.14	.02920	-70.47
48.000	.08779	-154.64	.89714	148.97	.89713	148.97	.03124	-63.97
48.250	.08938	-152.91	.89581	148.00	.89581	148.00	.03121	-60.84
48.500	.08828	-153.56	.89680	146.49	.89680	146.49	.03800	-67.82
48.750	.08988	-158.15	.89474	145.59	.89474	145.59	.03744	-61.92
49.000	.08956	-153.58	.89810	144.52	.89810	144.52	.03900	-73.07
49.250	.09103	-154.40	.89997	143.34	.89998	143.34	.04552	-60.49
49.500	.09230	-162.24	.89318	142.54	.89319	142.55	.04440	-53.86
49.750	.08425	-159.25	.89215	141.45	.89216	141.45	.03763	-60.17
50.000	.08818	-155.34	.89448	140.01	.89448	140.01	.03229	-52.56

On Wafer S Parameters @ + 25C

Isolation State

F (GHz)	S11 Mag	S11 Ang	S21 Mag	S21 Ang	S12 Mag	S12Ang	S22 Mag	S22 Ang
.500	.88147	-179.25	.00011	64.17	.00006	90.73	.24284	-53.34
.750	.88853	179.93	.00014	46.08	.00015	60.12	.20284	-69.33
1.000	.89183	179.19	.00011	27.97	.00003	27.97	.17097	-84.56
1.250	.89489	178.52	.00014	46.74	.00018	-6.39	.14758	-96.01
1.500	.89634	177.92	.00011	28.65	.00010	62.34	.12856	-105.54
1.750	.89771	177.28	.00016	20.85	.00013	2.42	.11649	-114.32
2.000	.89890	176.70	.00014	47.75	.00006	86.41	.10701	-123.25
2.250	.89965	176.11	.00011	29.64	.00014	156.51	.09692	-131.58
2.500	.90134	175.55	.00016	21.85	.00016	11.23	.08813	-138.66
2.750	.90063	174.97	.00014	48.75	.00014	78.50	.08119	-144.42
3.000	.90145	174.44	.00011	30.64	.00020	-25.67	.07662	-149.71
3.250	.90146	173.82	.00010	94.40	.00012	57.53	.07378	-155.81
3.500	.90166	173.29	.00010	94.75	.00025	41.62	.07051	-162.78
3.750	.90169	172.70	.00011	68.52	.00017	-7.44	.06667	-169.96
4.000	.90214	172.20	.00016	77.01	.00028	122.01	.06280	-176.75
4.250	.90215	171.68	.00015	95.80	.00015	109.83	.05921	176.57
4.500	.90253	171.11	.00015	96.17	.00023	15.63	.05655	169.60
4.750	.90210	170.57	.00020	96.52	.00025	85.21	.05447	161.21
5.000	.90302	170.04	.00021	82.85	.00022	54.77	.05230	151.18
5.250	.90275	169.50	.00020	111.29	.00026	117.00	.04977	139.96
5.500	.90329	168.94	.00030	97.62	.00032	77.06	.04798	127.87
5.750	.90278	168.43	.00030	97.98	.00026	106.11	.04821	114.94
6.000	.90321	167.91	.00035	98.38	.00037	98.38	.05149	99.29
6.250	.90288	167.37	.00040	98.75	.00035	94.67	.05744	81.43
6.500	.90286	166.86	.00050	99.16	.00053	97.48	.06655	63.14
6.750	.90290	166.31	.00060	90.10	.00060	88.31	.07988	46.78
7.000	.90306	165.79	.00074	80.34	.00073	83.98	.10200	32.48
7.250	.90269	165.26	.00102	71.39	.00104	70.07	.13872	17.55
7.500	.90227	164.76	.00133	52.93	.00135	53.15	.19562	-.07
7.750	.90275	164.21	.00172	28.25	.00172	28.25	.27708	-23.68
8.000	.90296	163.72	.00214	-4.71	.00213	-4.82	.34830	-55.24
8.250	.90240	163.20	.00200	-39.57	.00199	-40.36	.35014	-86.38
8.500	.90326	162.72	.00177	-68.64	.00179	-68.86	.31422	-110.07
8.750	.90278	162.17	.00162	-88.76	.00165	-87.00	.26986	-127.82
9.000	.90289	161.67	.00149	-103.50	.00148	-102.60	.23124	-140.11
9.250	.90298	161.13	.00137	-118.00	.00136	-118.90	.20335	-149.00
9.500	.90292	160.59	.00126	-128.37	.00127	-128.81	.18318	-155.99
9.750	.90281	160.09	.00128	-134.15	.00129	-135.26	.16757	-162.04
10.000	.90336	159.60	.00134	-142.46	.00134	-143.13	.15490	-167.17
10.250	.90306	159.08	.00127	-150.17	.00124	-149.71	.14488	-171.67
10.500	.90357	158.56	.00140	-153.34	.00139	-154.24	.13673	-175.72
10.750	.90179	158.19	.00148	-157.44	.00146	-155.39	.12967	-179.42
11.000	.90329	157.52	.00152	-159.10	.00156	-158.00	.12354	177.42
11.250	.90281	157.04	.00161	-165.96	.00161	-166.19	.11821	174.21
11.500	.90284	156.54	.00172	-170.35	.00171	-171.25	.11361	171.06
11.750	.90339	156.01	.00179	-174.45	.00179	-174.00	.10925	168.14
12.000	.90385	155.50	.00194	179.41	.00195	178.52	.10551	165.46
12.250	.90391	154.98	.00197	177.12	.00197	176.22	.10197	162.82
12.500	.90395	154.48	.00207	174.18	.00206	174.40	.09895	160.34
12.750	.90412	153.93	.00211	169.19	.00210	169.19	.09564	157.72
13.000	.90421	153.46	.00216	167.32	.00214	166.87	.09289	155.25
13.250	.90467	152.91	.00226	163.52	.00225	163.29	.09008	153.15
13.500	.90457	152.42	.00240	159.21	.00238	160.34	.08744	150.66
13.750	.90533	151.89	.00230	158.98	.00232	157.88	.08503	148.54
14.000	.90503	151.38	.00253	156.68	.00252	156.90	.08294	146.20

14.250	.90562	150.86	.00265	148.86	.00267	148.86	.08062	144.24
14.500	.90471	150.33	.00258	147.62	.00259	146.95	.07825	141.96
14.750	.90525	149.80	.00253	142.33	.00252	141.77	.07647	139.84
15.000	.90514	149.31	.00240	144.53	.00240	144.75	.07431	137.87
15.250	.90606	148.86	.00255	144.11	.00255	144.23	.07225	135.68
15.500	.90582	148.31	.00247	139.24	.00242	138.90	.07027	133.25
15.750	.90512	147.81	.00245	141.13	.00243	141.58	.06829	131.26
16.000	.90639	147.31	.00249	143.46	.00248	142.78	.06685	128.99
16.250	.90709	146.81	.00258	145.22	.00256	145.67	.06464	127.05
16.500	.90789	146.35	.00276	142.23	.00278	142.11	.06277	124.83
16.750	.90670	145.79	.00276	138.19	.00275	138.08	.06074	122.81
17.000	.90745	145.24	.00273	139.94	.00272	140.39	.05936	120.50
17.250	.90778	144.72	.00292	139.61	.00295	138.95	.05760	118.52
17.500	.90841	144.24	.00273	140.79	.00272	140.12	.05583	116.48
17.750	.90937	143.74	.00288	140.90	.00287	140.68	.05419	114.57
18.000	.90941	143.21	.00308	143.46	.00306	143.57	.05270	112.33
18.250	.90913	142.73	.00307	141.12	.00309	141.46	.05061	110.11
18.500	.90977	142.13	.00349	141.88	.00348	141.99	.04935	107.76
18.750	.91043	141.60	.00359	140.71	.00361	140.82	.04762	105.69
19.000	.91066	141.09	.00367	139.94	.00367	139.82	.04647	103.16
19.250	.91226	140.62	.00374	139.16	.00374	138.93	.04459	100.99
19.500	.91258	140.02	.00414	135.46	.00415	135.57	.04345	97.89
19.750	.91185	139.47	.00403	132.79	.00401	132.68	.04152	95.71
20.000	.91237	138.92	.00423	130.67	.00421	130.45	.04036	92.97
20.250	.91299	138.51	.00413	130.66	.00416	130.55	.03864	91.02
20.500	.91266	137.95	.00456	127.15	.00455	127.01	.03736	87.26
20.750	.91379	137.38	.00426	126.11	.00428	125.77	.03629	84.59
21.000	.91384	136.85	.00451	128.77	.00451	128.82	.03471	81.36
21.250	.91426	136.33	.00474	128.30	.00474	128.30	.03364	77.95
21.500	.91480	135.75	.00476	123.05	.00475	123.05	.03194	74.77
21.750	.91529	135.24	.00471	123.42	.00471	123.45	.02977	72.84
22.000	.91624	134.72	.00480	125.07	.00480	125.07	.03002	68.47
22.250	.91527	134.04	.00494	122.71	.00492	122.82	.02819	64.30
22.500	.91518	133.56	.00504	120.04	.00504	119.95	.02711	60.60
22.750	.91512	133.09	.00508	121.59	.00508	121.59	.02635	56.80
23.000	.91633	132.54	.00524	119.61	.00523	119.75	.02531	52.29
23.250	.91650	131.97	.00542	117.27	.00542	117.42	.02407	47.36
23.500	.91711	131.46	.00554	118.45	.00551	118.41	.02340	42.58
23.750	.91759	130.90	.00563	116.17	.00563	116.17	.02270	37.94
24.000	.91757	130.36	.00554	116.45	.00555	116.63	.02252	32.80
24.250	.91824	129.76	.00602	114.59	.00603	114.73	.02135	26.82
24.500	.91807	129.21	.00606	113.74	.00606	113.70	.02203	21.17
24.750	.91716	128.67	.00613	111.61	.00613	111.57	.02114	16.28
25.000	.91753	128.11	.00606	112.44	.00607	112.48	.02126	10.75
25.250	.91725	127.51	.00634	111.91	.00633	111.96	.02086	4.67
25.500	.91722	127.05	.00629	112.24	.00629	112.20	.02083	.49
25.750	.91726	126.48	.00667	109.50	.00667	109.74	.02130	-7.54
26.000	.91872	125.93	.00661	110.26	.00662	110.35	.02140	-10.60
26.250	.91707	125.38	.00667	110.47	.00668	110.44	.02220	-19.05
26.500	.91827	124.90	.00701	110.00	.00701	109.97	.02223	-22.17
26.750	.91766	124.35	.00708	109.08	.00709	109.06	.02216	-27.03
27.000	.91923	123.75	.00741	105.94	.00739	105.74	.02349	-30.52
27.250	.91861	123.27	.00715	105.35	.00715	105.39	.02376	-36.24
27.500	.91805	122.70	.00768	105.20	.00769	105.31	.02499	-38.03
27.750	.92100	122.12	.00775	105.55	.00774	105.44	.02532	-44.98
28.000	.91853	121.55	.00805	101.81	.00805	101.84	.02699	-46.54
28.250	.91896	120.95	.00798	102.39	.00800	102.53	.02699	-51.38
28.500	.91976	120.47	.00830	99.24	.00831	99.19	.02856	-52.83
28.750	.91877	119.85	.00840	99.33	.00839	99.26	.02946	-57.80
29.000	.91954	119.31	.00826	99.53	.00825	99.40	.03056	-60.74
29.250	.91880	118.71	.00857	96.84	.00859	96.92	.03140	-62.84
29.500	.92098	118.21	.00882	98.27	.00881	98.24	.03196	-65.45

29.750	.92023	117.58	.00873	94.87	.00873	94.92	.03327	-66.21
30.000	.91982	116.96	.00896	93.02	.00895	92.95	.03501	-68.99
30.250	.92040	116.39	.00899	93.73	.00899	93.91	.03540	-74.51
30.500	.92100	115.87	.00911	91.92	.00911	91.96	.03647	-74.81
30.750	.91981	115.22	.00953	95.90	.00953	95.91	.03770	-76.14
31.000	.91961	114.64	.01006	92.42	.01006	92.39	.03936	-77.83
31.250	.91920	114.12	.01019	90.46	.01018	90.40	.04069	-81.74
31.500	.91942	113.54	.01067	86.84	.01067	86.82	.04059	-83.72
31.750	.91874	112.92	.01053	86.99	.01053	87.04	.04152	-83.09
32.000	.91691	112.39	.01105	82.45	.01105	82.50	.04320	-87.82
32.250	.91823	111.85	.01088	80.11	.01088	80.18	.04350	-90.04
32.500	.91806	111.29	.01090	77.85	.01089	77.90	.04395	-91.15
32.750	.91851	110.66	.01128	80.12	.01128	80.15	.04492	-93.06
33.000	.91616	110.11	.01104	77.17	.01103	77.19	.04588	-95.58
33.250	.91684	109.51	.01061	71.09	.01061	71.07	.04699	-95.91
33.500	.91656	108.98	.01065	73.64	.01065	73.58	.04700	-98.13
33.750	.91620	108.28	.01047	73.33	.01047	73.33	.04769	-99.18
34.000	.91586	107.72	.01078	73.08	.01078	73.11	.04927	-100.17
34.250	.91411	107.07	.01094	71.96	.01094	71.84	.05135	-102.77
34.500	.91288	106.62	.01053	69.93	.01053	69.91	.05075	-104.61
34.750	.91278	105.91	.01060	67.75	.01060	67.77	.05111	-104.80
35.000	.91149	105.23	.01081	72.16	.01082	72.16	.05189	-106.63
35.250	.91155	104.72	.01108	71.78	.01108	71.84	.05276	-107.66
35.500	.91049	104.18	.01161	68.33	.01161	68.33	.05307	-110.14
35.750	.90881	103.65	.01102	62.17	.01102	62.22	.05399	-111.52
36.000	.90870	103.12	.01209	64.42	.01209	64.47	.05698	-113.98
36.250	.90954	102.67	.01195	65.65	.01195	65.63	.05678	-113.44
36.500	.90737	101.98	.01187	62.75	.01187	62.78	.05538	-116.43
36.750	.90682	101.52	.01185	57.96	.01185	57.97	.05556	-119.29
37.000	.90987	101.03	.01148	55.82	.01148	55.79	.05546	-120.24
37.250	.90920	100.33	.01147	58.36	.01147	58.36	.05585	-121.92
37.500	.90734	99.68	.01154	59.20	.01153	59.20	.05662	-122.01
37.750	.90359	99.14	.01092	63.42	.01092	63.46	.05669	-123.45
38.000	.90251	98.58	.01160	57.05	.01160	57.06	.05686	-123.59
38.250	.90400	98.06	.01152	55.64	.01152	55.60	.05627	-124.97
38.500	.90711	97.45	.01211	55.76	.01211	55.79	.05806	-126.29
38.750	.90357	96.78	.01162	57.39	.01162	57.35	.05774	-128.46
39.000	.90484	96.02	.01160	55.88	.01160	55.86	.05784	-129.56
39.250	.90320	95.69	.01192	54.41	.01193	54.37	.05648	-133.19
39.500	.90212	94.85	.01282	50.97	.01283	50.97	.05544	-133.99
39.750	.90222	94.37	.01239	52.51	.01239	52.49	.05493	-134.76
40.000	.89882	93.94	.01302	54.02	.01302	54.02	.05698	-133.43
40.250	.90193	93.62	.01287	54.48	.01287	54.48	.05565	-137.01
40.500	.90087	92.80	.01275	50.73	.01275	50.72	.05670	-136.49
40.750	.90172	92.09	.01311	46.94	.01311	46.93	.05300	-141.00
41.000	.90095	91.55	.01434	47.97	.01434	47.97	.05473	-139.10
41.250	.89982	90.99	.01385	46.06	.01384	46.06	.05387	-143.41
41.500	.89697	90.29	.01309	49.46	.01309	49.46	.05313	-142.17
41.750	.90063	89.83	.01409	48.88	.01409	48.89	.05285	-144.68
42.000	.89610	88.96	.01480	45.53	.01480	45.49	.05357	-145.77
42.250	.89174	88.57	.01436	41.76	.01436	41.79	.05060	-147.85
42.500	.89827	87.77	.01474	45.61	.01474	45.62	.05082	-147.75
42.750	.89377	87.42	.01510	45.47	.01509	45.45	.05084	-148.75
43.000	.89370	86.97	.01617	45.72	.01617	45.73	.04702	-151.51
43.250	.88419	85.92	.01579	39.21	.01578	39.19	.04638	-153.83
43.500	.89400	85.87	.01534	32.53	.01534	32.52	.05028	-155.99
43.750	.89849	85.00	.01793	35.43	.01793	35.42	.04426	-156.34
44.000	.88778	84.46	.01646	34.58	.01646	34.58	.04224	-155.20
44.250	.88322	84.11	.01685	32.39	.01685	32.40	.04415	-158.65
44.500	.88747	83.25	.01736	31.37	.01736	31.37	.04027	-161.39
44.750	.88749	83.13	.01834	28.00	.01834	28.00	.03925	-163.03
45.000	.88364	82.31	.01674	27.19	.01674	27.20	.03731	-159.73

AlGaAs SPST Non-Reflective PIN Diode Switch

MA4AGSW1A

Rev 2.0

45.250	.88817	81.86	.01867	24.67	.01867	24.66	.03495	-164.75
45.500	.88906	81.15	.01756	24.56	.01756	24.55	.03577	-164.30
45.750	.87946	80.34	.01878	22.75	.01878	22.74	.02962	-165.35
46.000	.88375	79.52	.01908	20.50	.01908	20.51	.02558	-171.18
46.250	.88489	79.27	.01856	19.00	.01856	19.01	.02677	-171.87
46.500	.88585	78.37	.01868	16.71	.01868	16.71	.02601	-171.42
46.750	.88322	78.04	.01937	10.12	.01937	10.12	.02571	179.04
47.000	.88351	77.97	.01760	12.10	.01760	12.10	.02333	178.07
47.250	.88479	77.22	.01887	15.77	.01887	15.77	.01479	166.91
47.500	.88159	76.92	.02033	12.08	.02033	12.08	.01822	-174.44
47.750	.87769	76.14	.01972	8.67	.01972	8.66	.01535	166.18
48.000	.87898	75.15	.01654	5.78	.01654	5.78	.00877	150.90
48.250	.88740	74.32	.01797	10.38	.01798	10.38	.00688	135.18
48.500	.88169	73.52	.01842	-.69	.01842	-.69	.00346	129.61
48.750	.88029	73.32	.01864	4.16	.01864	4.17	.00576	78.42
49.000	.88487	72.80	.01965	-.91	.01965	-.91	.00479	56.34
49.250	.86841	72.20	.01774	3.71	.01773	3.70	.01132	29.70
49.500	.87164	71.80	.02049	.36	.02049	.35	.00945	26.52
49.750	.87549	70.74	.01992	-6.32	.01992	-6.33	.01368	30.04
50.000	.86901	69.62	.01982	-1.00	.01982	-1.00	.01961	21.35