

# FDC6331L

## Integrated Load Switch

### General Description

This device is particularly suited for compact power management in portable electronic equipment where 2.5V to 8V input and 2.8A output current capability are needed. This load switch integrates a small N-Channel power MOSFET (Q1) that drives a large P-Channel power MOSFET (Q2) in one tiny SuperSOT™-6 package.

### Applications

- Load switch
- Power management



### Features

- -2.8 A, -8 V.  $R_{DS(ON)} = 55\text{ m}\Omega @ V_{GS} = -4.5\text{ V}$   
 $R_{DS(ON)} = 70\text{ m}\Omega @ V_{GS} = -2.5\text{ V}$   
 $R_{DS(ON)} = 100\text{ m}\Omega @ V_{GS} = -1.8\text{ V}$
- Control MOSFET (Q1) includes Zener protection for ESD ruggedness (>6KV Human body model)
- High performance trench technology for extremely low  $R_{DS(ON)}$

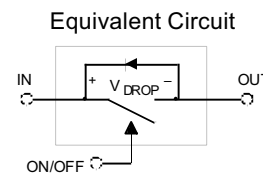
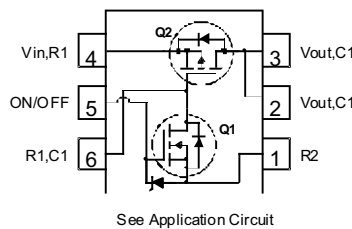
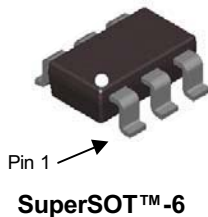

### Absolute Maximum Ratings T<sub>A</sub>=25°C unless otherwise noted

Symbol	Parameter	Ratings	Units
V <sub>IN</sub>	Maximum Input Voltage	± 8	V
V <sub>ON/OFF</sub>	High level ON/OFF voltage range	-0.5 to 8	V
I <sub>Load</sub>	Load Current – Continuous (Note 1)	2.8	A
	– Pulsed	9	
P <sub>D</sub>	Maximum Power Dissipation (Note 1)	0.7	W
T <sub>J</sub> , T <sub>STG</sub>	Operating and Storage Junction Temperature Range	-55 to +150	°C

### Thermal Characteristics

R <sub>θJA</sub>	Thermal Resistance, Junction-to-Ambient (Note 1)	180	°C/W
R <sub>θJC</sub>	Thermal Resistance, Junction-to-Case (Note 1)	60	°C/W

### Package Marking and Ordering Information

Device Marking	Device	Reel Size	Tape width	Quantity
.331	FDC6331L	7"	8mm	3000 units

### Electrical Characteristics

$T_A = 25^\circ\text{C}$  unless otherwise noted

Symbol	Parameter	Test Conditions	Min	Typ	Max	Units
<b>Off Characteristics</b>						
$BV_{IN}$	Vin Breakdown Voltage	$V_{ON/OFF} = 0\text{ V}$ , $I_D = -250\ \mu\text{A}$	8			V
$I_{Load}$	Zero Gate Voltage Drain Current	$V_{IN} = 6.4\text{ V}$ , $V_{ON/OFF} = 0\text{ V}$			-1	$\mu\text{A}$
$I_{FL}$	Leakage Current, Forward	$V_{ON/OFF} = 0\text{ V}$ , $V_{IN} = 8\text{ V}$			-100	nA
$I_{RL}$	Leakage Current, Reverse	$V_{ON/OFF} = 0\text{ V}$ , $V_{IN} = -8\text{ V}$			100	nA
<b>On Characteristics (Note 2)</b>						
$V_{ON/OFF(th)}$	Gate Threshold Voltage	$V_{IN} = V_{ON/OFF}$ , $I_D = -250\ \mu\text{A}$	0.4	0.9	1.5	V
$R_{DS(on)}$	Static Drain-Source On-Resistance (Q2)	$V_{GS} = -4.5\text{ V}$ , $I_D = -2.8\text{ A}$ $V_{GS} = -2.5\text{ V}$ , $I_D = -2.5\text{ A}$ $V_{GS} = -1.8\text{ V}$ , $I_D = -2.0\text{ A}$		34 45 64	55 70 100	m $\Omega$
$R_{DS(on)}$	Static Drain-Source On-Resistance (Q1)	$V_{GS} = 4.5\text{ V}$ , $I_D = 0.4\text{ A}$ $V_{GS} = 2.7\text{ V}$ , $I_D = 0.2\text{ A}$		3.1 3.8	4 5	$\Omega$
<b>Drain-Source Diode Characteristics and Maximum Ratings</b>						
$I_S$	Maximum Continuous Drain-Source Diode Forward Current				-0.6	A
$V_{SD}$	Drain-Source Diode Forward Voltage	$V_{ON/OFF} = 0\text{ V}$ , $I_S = -0.6\text{ A}$ (Note 2)			-1.2	V

**Notes:**

1.  $R_{\theta JA}$  is the sum of the junction-to-case and case-to-ambient thermal resistance where the case thermal reference is defined as the solder mounting surface of the drain pins.  $R_{\theta JC}$  is guaranteed by design while  $R_{\theta JA}$  is determined by the user's board design.

2. Pulse Test: Pulse Width < 300 $\mu\text{s}$ , Duty Cycle < 2.0%.

### FDC6331L Load Switch Application Circuit

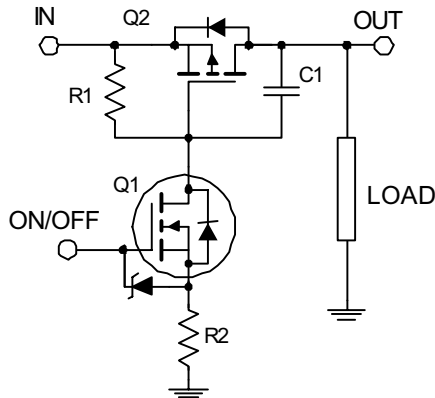

**External Component Recommendation:**

For additional in-rush current control, R2 and C1 can be added. For more information, see application note AN1030.

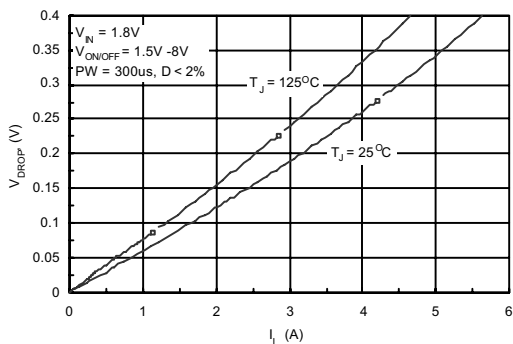

Figure 1. Conduction Voltage Drop Variation with Load Current.

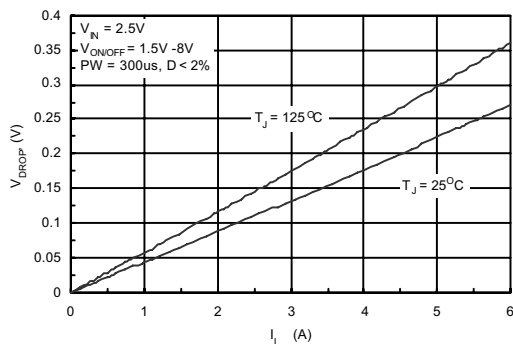

Figure 2. Conduction Voltage Drop Variation with Load Current.

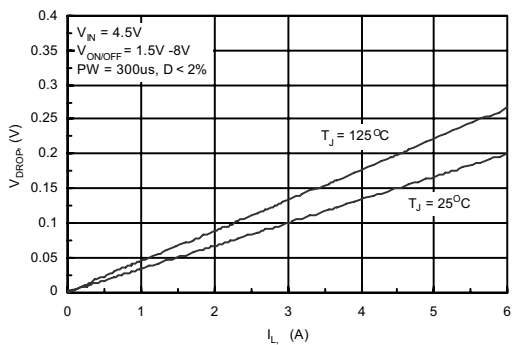

Figure 3. Conduction Voltage Drop Variation with Load Current.

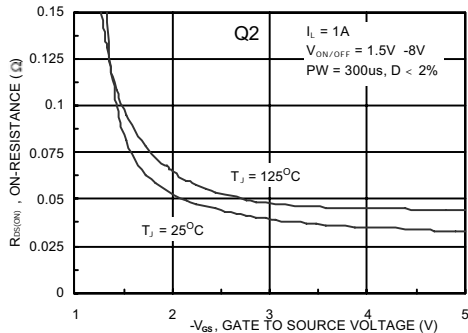

Figure 4. On-Resistance Variation With Input Voltage

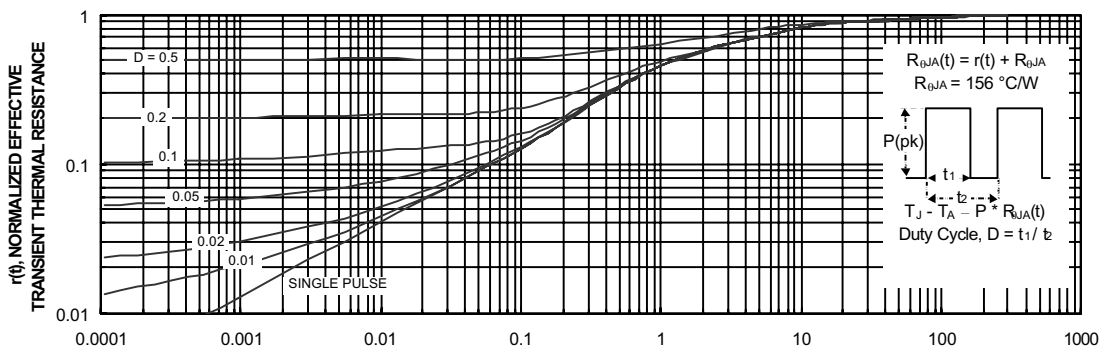



Figure 5. Transient Thermal Response Curve.

Thermal characterization performed on the conditions described in Note 2. Transient thermal response will change depends on the circuit board design.



**TRADEMARKS**

The following are registered and unregistered trademarks Fairchild Semiconductor owns or is authorized to use and is not intended to be an exhaustive list of all such trademarks.

ACEx®	HiSeC™	Programmable Active Droop™	TinyLogic®
Across the board. Around the world™	<i>i-Lo</i> ™	QFET®	TINYOPTO™
ActiveArray™	ImpliedDisconnect™	QS™	TinyPower™
Bottomless™	IntelliMAX™	QT Optoelectronics™	TinyWire™
Build it Now™	ISOPLANAR™	Quiet Series™	TruTranslation™
CoolFET™	MICROCOUPLER™	RapidConfigure™	µSerDes™
CROSSVOLT™	MicroPak™	RapidConnect™	UHC®
CTL™	MICROWIRE™	ScalarPump™	UniFET™
Current Transfer Logic™	MSX™	SMART START™	VCX™
DOME™	MSXPro™	SPM®	Wire™
E <sup>2</sup> CMOS™	OCX™	STEALTH™	
EcoSPARK®	OCXPro™	SuperFET™	
EnSigna™	OPTOLOGIC®	SuperSOT™-3	
FACT Quiet Series™	OPTOPLANAR®	SuperSOT™-6	
FACT®	PACMAN™	SuperSOT™-8	
FAST®	POP™	SyncFET™	
FASTr™	Power220®	TCM™	
FPS™	Power247®	The Power Franchise®	
FRFET®	PowerEdge™	 ™	
GlobalOptoisolator™	PowerSaver™	TinyBoost™	
GTO™	PowerTrench®	TinyBuck™	

**DISCLAIMER**

FAIRCHILD SEMICONDUCTOR RESERVES THE RIGHT TO MAKE CHANGES WITHOUT FURTHER NOTICE TO ANY PRODUCTS HEREIN TO IMPROVE RELIABILITY, FUNCTION OR DESIGN. FAIRCHILD DOES NOT ASSUME ANY LIABILITY ARISING OUT OF THE APPLICATION OR USE OF ANY PRODUCT OR CIRCUIT DESCRIBED HEREIN; NEITHER DOES IT CONVEY ANY LICENSE UNDER ITS PATENT RIGHTS, NOR THE RIGHTS OF OTHERS. THESE SPECIFICATIONS DO NOT EXPAND THE TERMS OF FAIRCHILD'S WORLDWIDE TERMS AND CONDITIONS, SPECIFICALLY THE WARRANTY THEREIN, WHICH COVERS THESE PRODUCTS.

**LIFE SUPPORT POLICY**

FAIRCHILD'S PRODUCTS ARE NOT AUTHORIZED FOR USE AS CRITICAL COMPONENTS IN LIFE SUPPORT DEVICES OR SYSTEMS WITHOUT THE EXPRESS WRITTEN APPROVAL OF FAIRCHILD SEMICONDUCTOR CORPORATION.

As used herein:

1. Life support devices or systems are devices or systems which, (a) are intended for surgical implant into the body or (b) support or sustain life, and (c) whose failure to perform when properly used in accordance with instructions for use provided in the labeling, can be reasonably expected to result in a significant injury of the user.
2. A critical component in any component of a life support, device, or system whose failure to perform can be reasonably expected to cause the failure of the life support device or system, or to affect its safety or effectiveness.

**PRODUCT STATUS DEFINITIONS**

**Definition of Terms**

Datasheet Identification	Product Status	Definition
Advance Information	Formative or In Design	This datasheet contains the design specifications for product development. Specifications may change in any manner without notice.
Preliminary	First Production	This datasheet contains preliminary data; supplementary data will be published at a later date. Fairchild Semiconductor reserves the right to make changes at any time without notice to improve design.
No Identification Needed	Full Production	This datasheet contains final specifications. Fairchild Semiconductor reserves the right to make changes at any time without notice to improve design.
Obsolete	Not In Production	This datasheet contains specifications on a product that has been discontinued by Fairchild Semiconductor. The datasheet is printed for reference information only.