



T-25-19

FT250DM

Powerex, Inc. Hillis Street, Youngwood, Pennsylvania 15697 (412) 925-7272
 Powerex Europe, S.A., 428 Ave. G. Durand, BP107, 72003 LeMans, France (43) 72.75.15

Phase Control SCR
250 Amperes Avg
200-1800 Volts

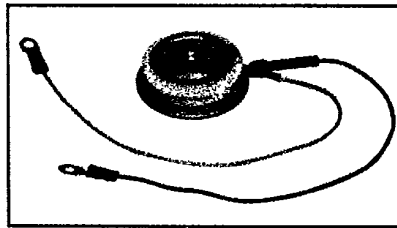
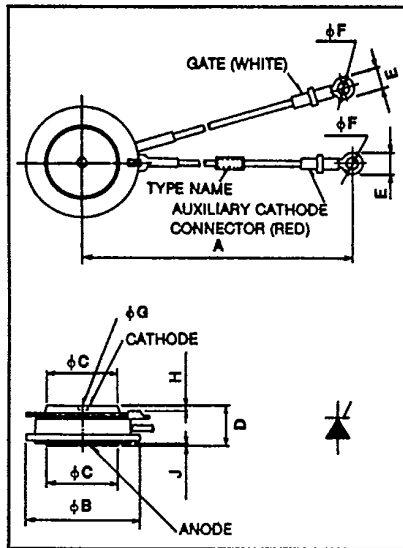

FT250DM
Phase Control SCR
 250 Amperes/200-1800 Volts

Description

Powerex Silicon Controlled Rectifiers (SCR) are designed for phase control applications. These are all-diffused, Press-Pak (Pow-R-Disc) devices employing center-fired gate.

Features:

- Low On-State Voltage
- High di/dt
- High dv/dt
- Hermetic Packaging
- Excellent Surge and I²t Ratings

Applications:

- Power Supplies
- Battery Chargers
- Motor Control
- Light Dimmers
- VAR Generators

Ordering Information

Example: Select the complete eight or nine digit part number you desire from the table - i.e. FT250DM-16 is a 800 Volt, 250 Ampere Phase Control SCR.

Type	Voltage*		Current
	V _{ORM} V _{RRM}	Code	
FT250DM	200	-4	250
	300	-6	
	400	-8	
	500	-10	
	600	-12	
	800	-16	
	1000	-20	
	1200	-24	
	1400	-28	
	1600	-32	
	1800	-36	

*Voltage classes 8, 12, 16, 24, 32, and 36 are standard products.

FT250DM
Outline Drawing

Dimensions	Inches	Metric
A	12.60 ± .30	320 ± 8
φB	1.693 Max	43 Max
φC	.945	24
D	.57 ± .02	14.5 ± 0.5
E	.30	7.5
φF	.169	4.3
φG ¹	.138	3.5
H	.04 Min	1.0 Min
J	.02 Min	0.4 Min

¹Depth .04 in. or 1 mm



T-25-19

Powerex, Inc., Hillis Street, Youngwood, Pennsylvania 15697 (412) 925-7272
 Powerex Europe, S.A., 428 Ave. G. Durand, BP107, 72003 LeMans, France (43) 72.75.15

FT250DM
Phase Control SCR
 250 Amperes Avg/200-1800 Volts

Absolute Maximum Ratings

	Symbol	FT250DM	Units
RMS On-State Current	$I_{T(RMS)}$	400	Amperes
Average On-State Current	$I_{T(av)}$	250	Amperes
Peak One-Cycle Surge (Non Repetitive) On-State Current (60Hz)	I_{TSM}	5000	Amperes
Peak One-Cycle Surge (Non-Repetitive) On-State Current (50Hz)	I_{TSM}	4550	Amperes
Critical Rate-of-Rise of On-State Current (Non-Repetitive)	di/dt	300	Amperes/ μ s
Critical Rate-of-Rise of On-State Current (Repetitive)	di/dt	100	Amperes/ μ s
I^2t (for Fusing), one cycle at 60Hz	I^2t	1.0×10^5	A ² sec
Peak Gate Power Dissipation	P_{GM}	10	Watts
Average Gate Power Dissipation	$P_{G(av)}$	3	Watts
Storage Temperature	T_{STG}	-40 to 150	°C
Operating Temperature'	T_J	-40 to 125	°C
Mounting Force [ⓐ]		1200 to 1585	lb.
Mounting Force [ⓐ]		540 to 720	kg

[ⓐ] Consult recommended mounting procedures.



T-25-19

Powerex, Inc., Hillis Street, Youngwood, Pennsylvania 15697 (412) 925-7272

Powerex Europe, S.A., 428 Ave. G. Durand, BP107, 72003 LeMans, France (43) 72.75.15

FT250DM

Phase Control SCR

250 Amperes Avg/200-1800 Volts

Electrical and Thermal Characteristics

Characteristics	Symbol	Test Conditions	FT250DM	Units
Voltage—Blocking State Maximums				
Forward Leakage, Peak	I_{DRM}	$T_J = 125^\circ\text{C}$, V_{DRM} applied	15	mA
Reverse Leakage, Peak	I_{RRM}	$T_J = 125^\circ\text{C}$, V_{RRM} applied	15	mA
Current—Conducting State Maximums				
Peak On-State Voltage	V_{TM}	$I_{TM} = 780\text{A}$, $T_J = 125^\circ\text{C}$	1.80	Volts
Switching				
Min. Critical dv/dt exponential to V_{DRM}	dv/dt	$T_J = 125^\circ\text{C}$, $V_D = \frac{1}{2}V_{DRM}$	100	V/ μsec
Thermal				
Maximum Thermal Resistance [Ⓞ] , double sided cooling Junction to Sink	$R_{\theta JS}$		0.15	$^\circ\text{C}/\text{Watt}$
Gate—Maximum Parameters				
Gate Current to Trigger	I_{GT}	$V_D = 6\text{V}$, $T_J = 25^\circ\text{C}$, $R_L = 2\Omega$	200	mA
Gate Voltage to Trigger	V_{GT}	$V_D = 6\text{V}$, $T_J = 25^\circ\text{C}$, $R_L = 2\Omega$	1.5	Volts
Non-Triggering Gate Voltage	V_{GDM}	$T_J = 125^\circ\text{C}$, $V_D = \frac{1}{2}V_{DRM}$.25	Volts
Peak Forward Gate Current	I_{GTM}		4.0	Amperes
Peak Reverse Gate Voltage	V_{GRM}		5.0	Volts

[Ⓞ] Consult recommended mounting procedures.



Powerex, Inc., Hillis Street, Youngwood, Pennsylvania 15697 (412) 925-7272
 Powerex Europe, S.A., 428 Ave. G. Durand, BP107, 72003 LeMans, France (43) 72.75.15

FT250DM
 Phase Control SCR
 250 Amperes Avg/200-1800 Volts

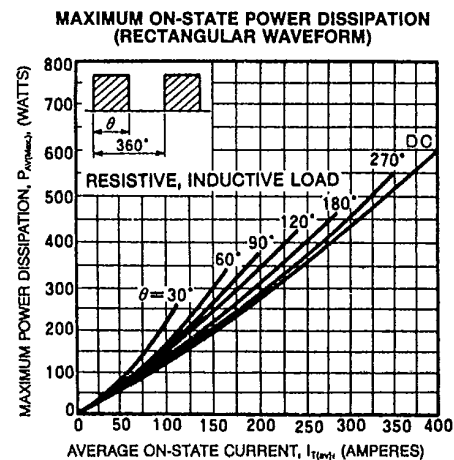
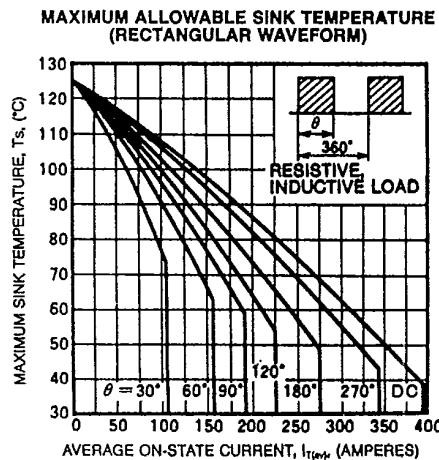
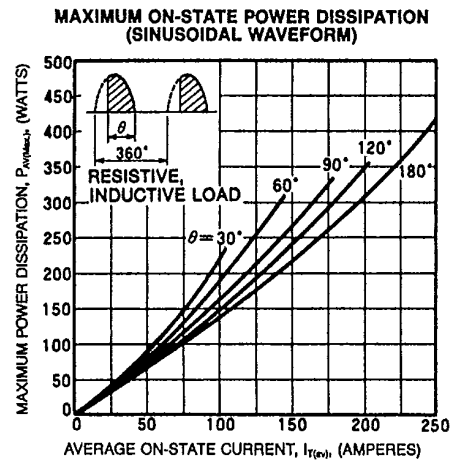
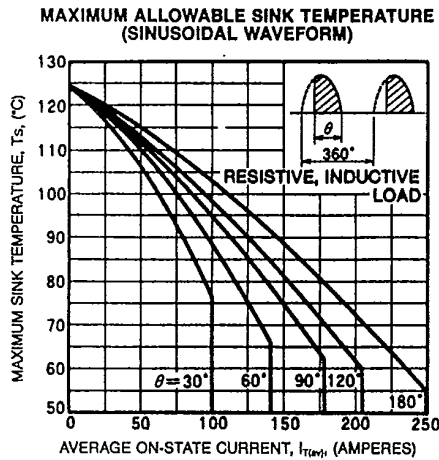
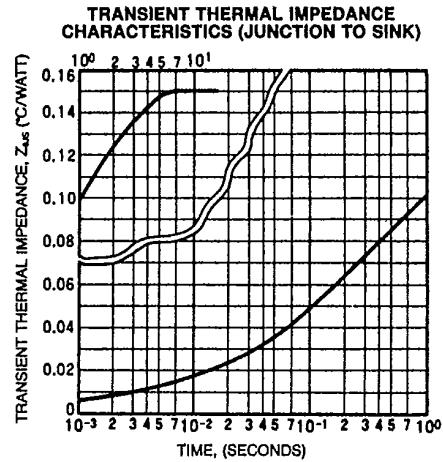
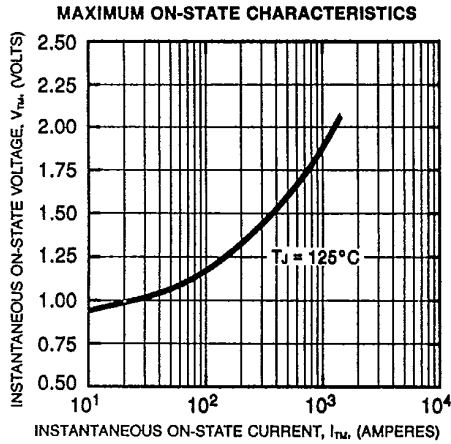



Powerex, Inc., Hillis Street, Youngwood, Pennsylvania 15697 (412) 925-7272
 Powerex Europe, S.A., 428 Ave. G. Durand, BP107, 72003 LeMans, France (43) 72.75.15

FT250DM
 Phase Control SCR
 250 Amperes Avg/200-1800 Volts

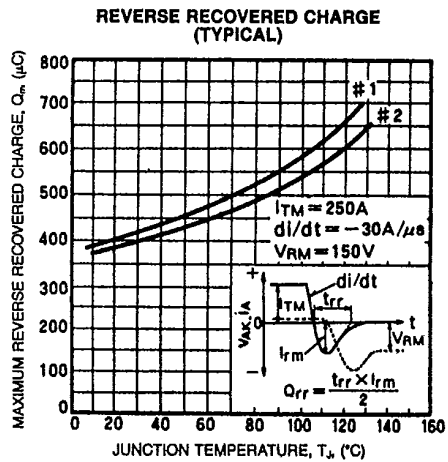
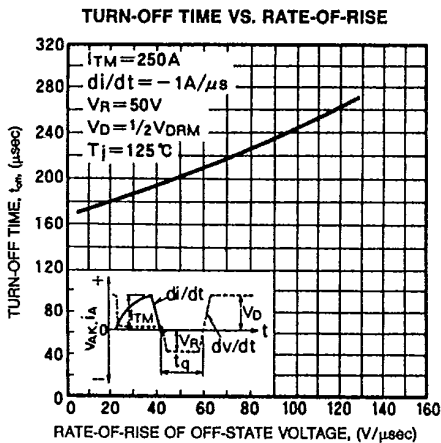
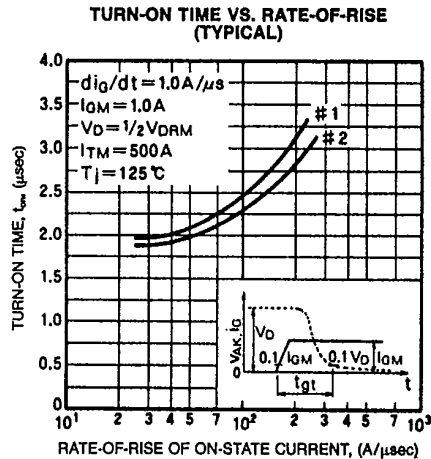
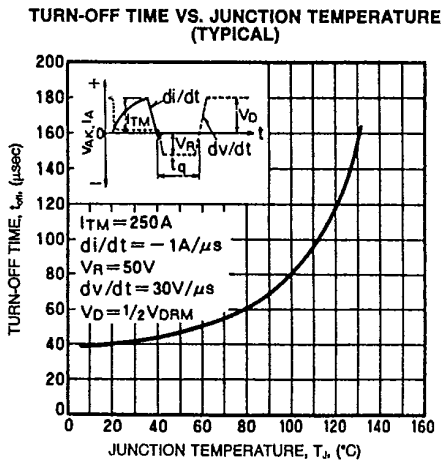
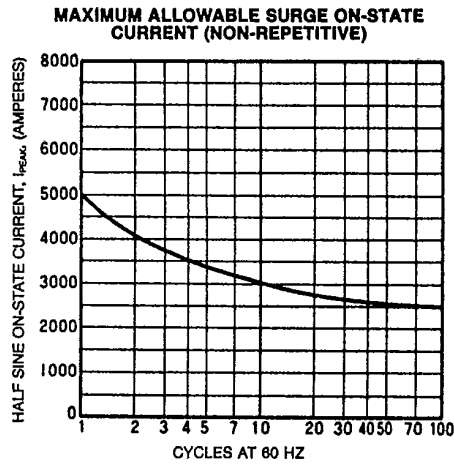
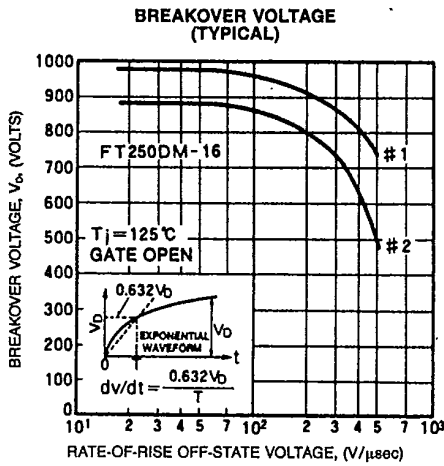



Powerex, Inc., Hillis Street, Youngwood, Pennsylvania 15697 (412) 925-7272
 Powerex Europe, S.A., 428 Ave. G. Durand, BP107, 72003 LeMans, France (43) 72.75.15

FT250DM
 Phase Control SCR
 250 Amperes Avg/200-1800 Volts

