IRU3039 EVALUATION BOARD USER GUIDE**INTRODUCTION**

The IRU3039 controller IC is designed to provide a synchronous Buck regulator and is targeted for applications where the cost and size is critical. The IRU3039 operates with a single input supply up to 20V. The output voltage can be programmed as low as 0.8V for low voltage applications. Selectable current limit is provided to tailor to external MOSFET's on-resistance for optimum cost and performance. The IRU3039 features an uncommitted error amplifier for tracking output voltage and is capable of sourcing or sinking current for applications such as DDR bus termination.

This device features a programmable switching frequency set from 200KHz to 400KHz, under-voltage lockout for both Vcc and Vc supplies, an external programmable soft-start function as well as output under-voltage detection that latches off the device when an output short is detected.

SPECIFICATION DATA**Switcher:**

$$V_{IN} = 18V$$

$$V_{OUT} = 3.3V$$

$$I_{OUT} = 8A$$

$$\Delta V_{OUT} = 100mV$$

$$FS = 200KHz$$

INPUT/OUTPUT CONNECTIONS

The following is the input/output connections:

Inputs:

JP1: Input (+18V), Gnd

Outputs:

JP2: V_{OUT} (+3.3V), Gnd

The connection points is shown in Figure 1. Connect the power supply cables according to this figure, minimize wire lengths to reduce losses in the wire. Test point J1 provides easy connections for the oscilloscope voltage probe to monitor the output voltage.

CONNECTION DIAGRAM

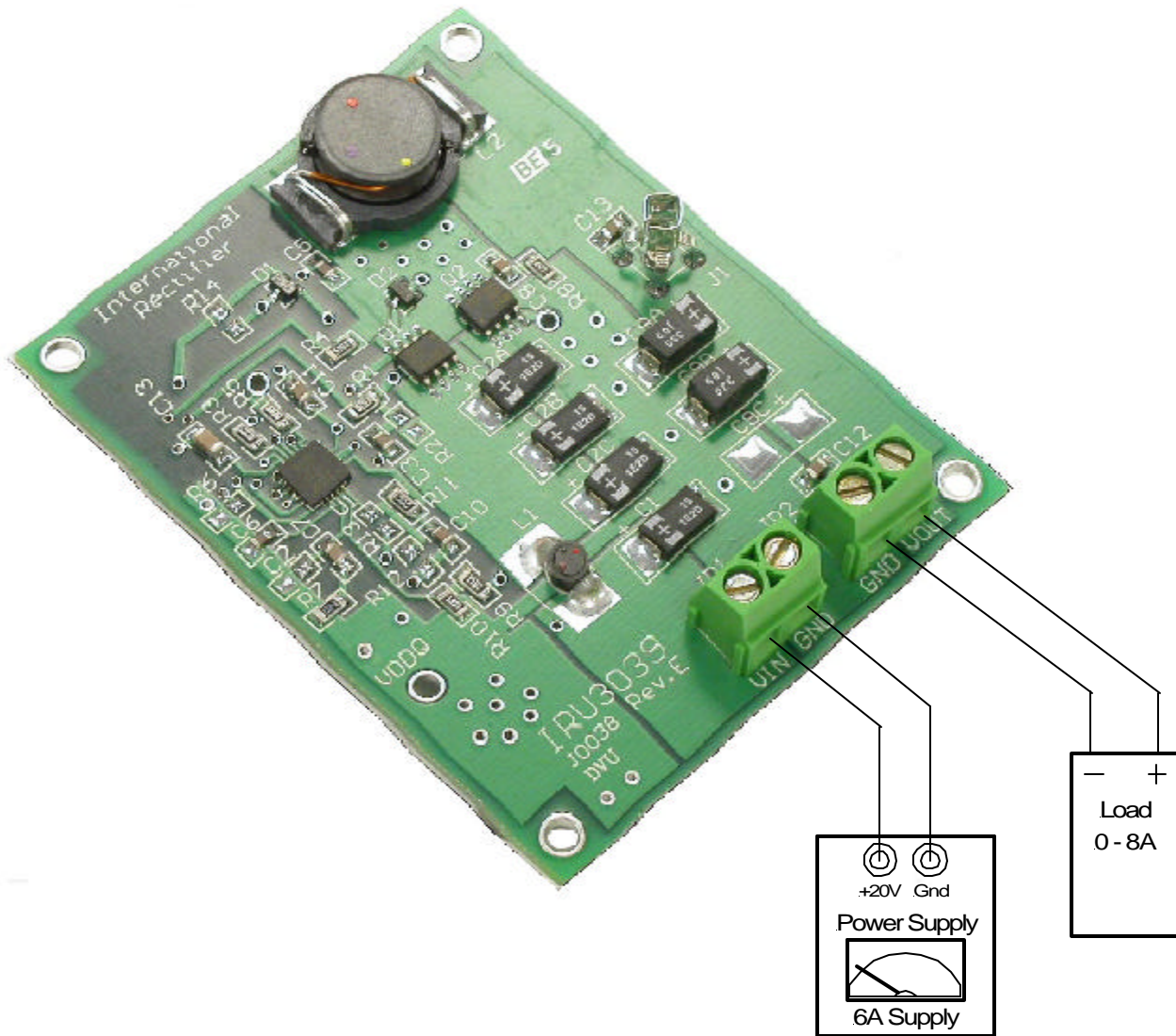

Figure 1 - Connection diagram of evaluation-board for IRU3039.

LAYOUT

The four layers for IRU3039 evaluation board are shown in Figures 2.1-2.4. The input capacitors are all located close to the MOSFETs. All the decoupling capacitors, charge pump capacitor and feedback components are located close to IC. The feedback resistors are tied to the output voltage at the point of regulation.

The middle layers are dedicated to Power Ground and Analog Ground. Analog Ground is kept separated from the Power Ground and it is connected at a single point as shown in figure 2.1.

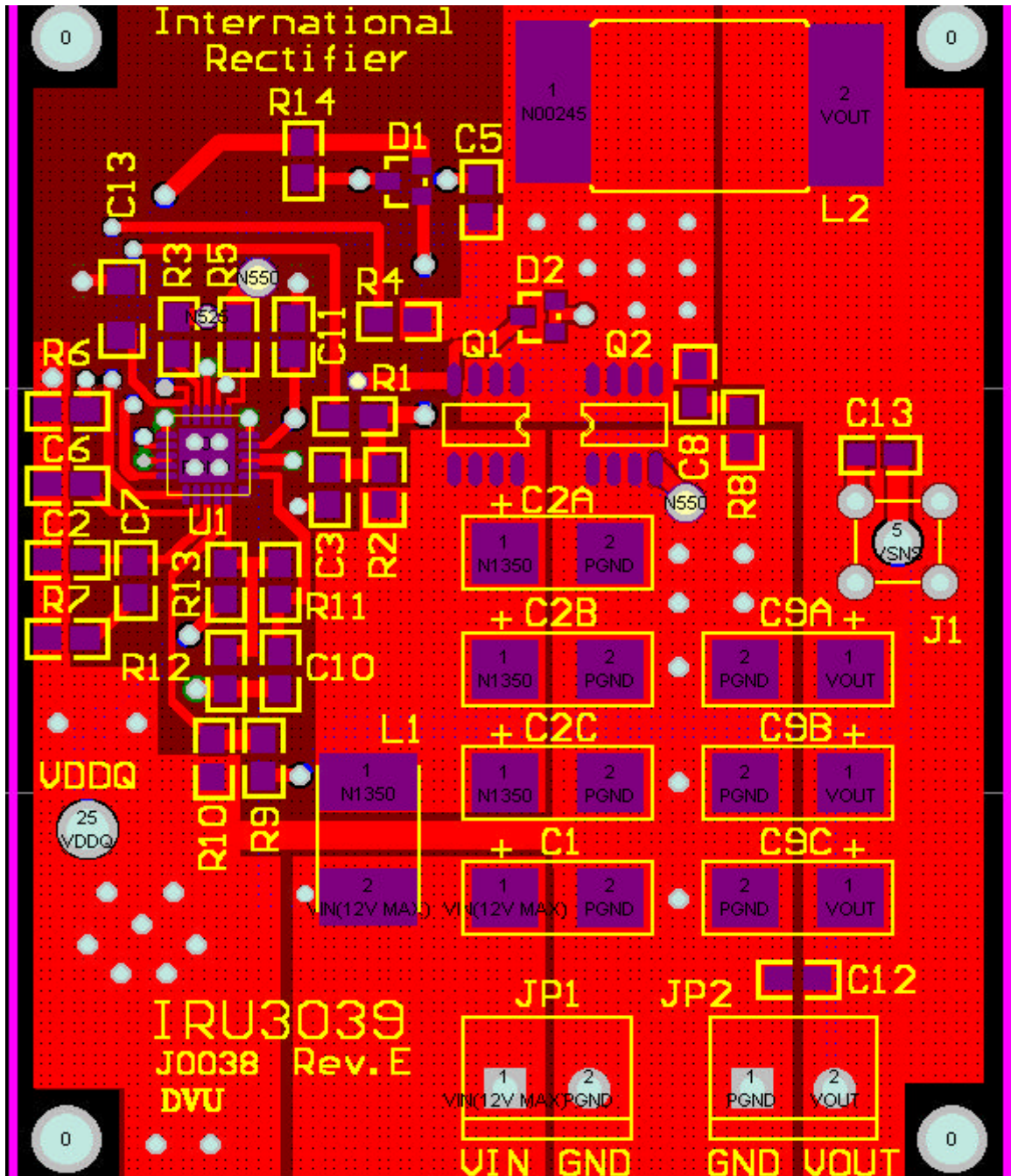
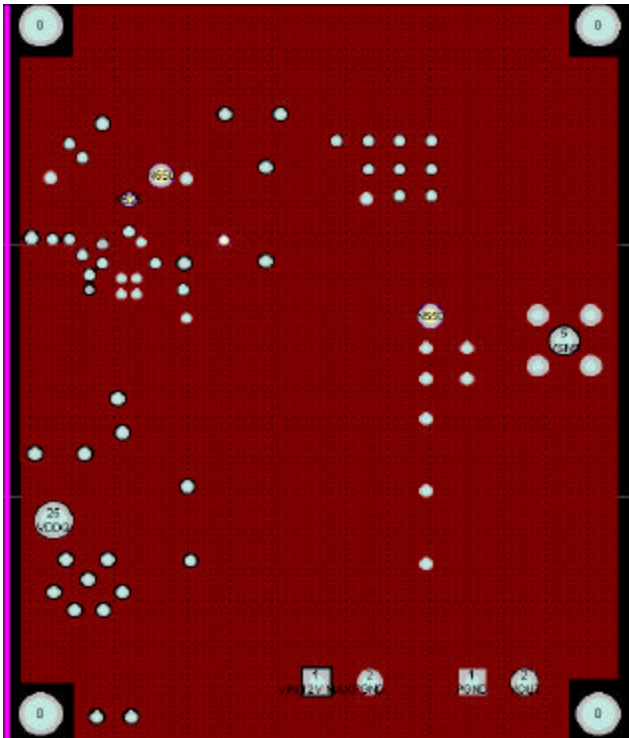
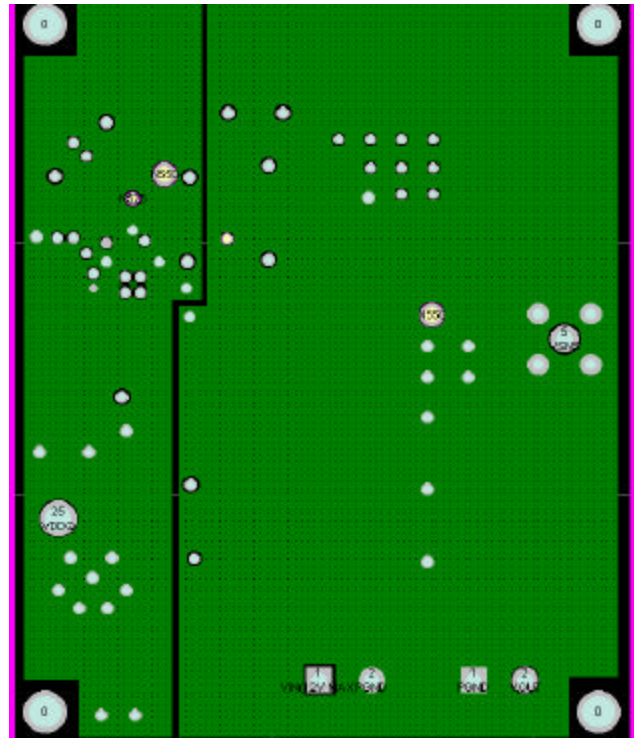

Figure 2.1 - Top layer of evaluation-board for IRU3039.



PGnd

Figure 2.2 - Middle layer 1.



AnGnd

PGnd

Figure 2.3 - Middle layer 2.

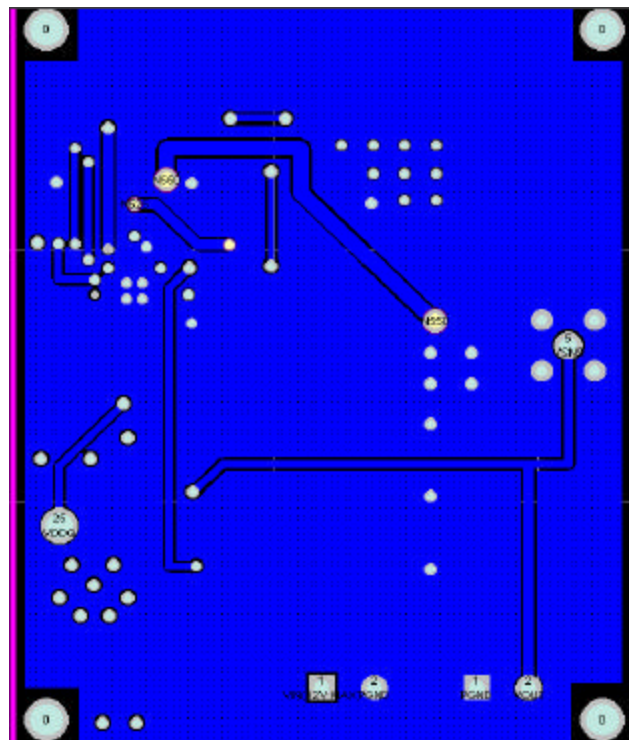

Figure 2.4 - Bottom layer.

SCHEMATIC

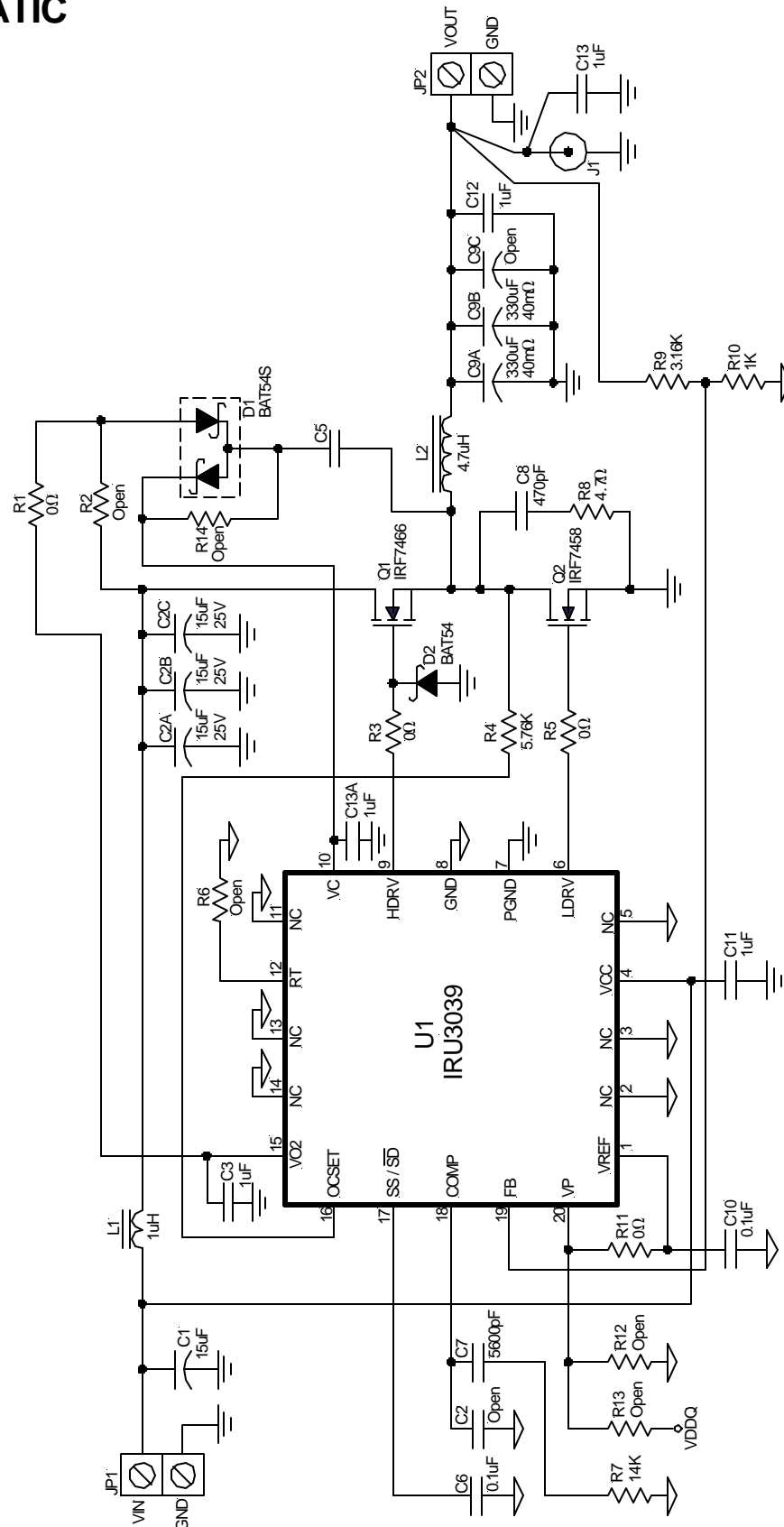

Figure 3 - Schematic of evaluation-board for IRU3039.

BILL OF MATERIAL

Ref Desig	Description	Value	Qty	Part#	Manuf	Web site (www.)
Q1	MOSFET	30V, 12.5mΩ, 11A	1	IRF7466	IR	irf.com
Q2	MOSFET	30V, 8mΩ, 14A	1	IRF7458	IR	
U1	Controller	Synchronous PWM	1	IRU3039	IR	
D1	Schottky Diode	Fast Switching	1	BAT54S	IR	
D2	Schottky Diode	Fast Switching	1	BAT54	IR	
L1	Inductor	1μH, 3A	1	DS1608C-102	Coilcraft	coilcraft.com
L2	Inductor	4.7μH, 13A	1	DO5022P-472HC	Coilcraft	
C1,C2A,B,C	Cap, Poscap	15μF, 25V	4	25TQC15M	Sanyo	sanyo.com
C5,6,10	Capacitor	0.1μF, Y5V, 25V	3	ECJ-2VF1E104Z	Panasonic	maco.panasonic.co.jp
C7	Capacitor	5600pF, X7R, 50V	1	ECU-V1H562KBG	Panasonic	
C8	Capacitor	470pF, X7R, 50V	1	ECJ-2VC1H471J	Panasonic	
C9A,B	Cap, Poscap	330uF, 40mΩ	2	6TPB-330M	Sanyo	sanyo.com
C3,11,12,13	Capacitor	1μF, Y5V, 16V	4	ECJ-2VF1C105Z	Panasonic	maco.panasonic.co.jp
C13A	Capacitor	1μF, X7R, 25V	1	ECJ-3YB1E105K	Panasonic	
R4	Resistor	5.76K, 1%	1			
R7	Resistor	14K, 1%	1			
R8	Resistor	4.7Ω, 1%	1			
R9	Resistor	3.16K, 1%	1			
R10	Resistor	1K, 1%	1			
R1,3,5,11	Resistor	0Ω	4			
R2,6,12,13,14	Resistor	Open(NA)	5			
C2,C9C	Capacitor	Open	2			
JP1,JP2	Connector	2 Positive Terminal	2	ED1973-ND	Digikey	
J1	Scope Probe		1	131-50310-00	Textronix	

TYPICAL OPERATING CHARACTERISTICS

Test Conditions:

$V_{IN}=20V$, $V_{OUT}=3.3V$, $I_{OUT}=0-8A$, $F_s=200KHz$

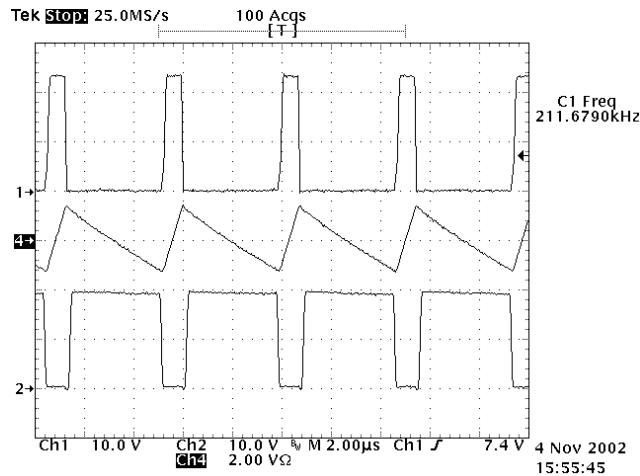

Figure 4 - Normal condition at No Load.
 Ch1: HDrv, Ch2: LDrv, Ch4: Inductor Current

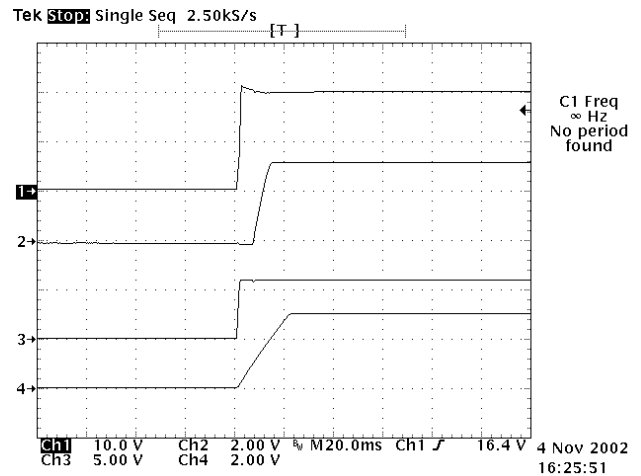

Figure 5 - Soft-Start.
 Ch1: V_{IN} , Ch2: V_{OUT} , Ch3: V_{OUT2} , Ch4: V_{SS}

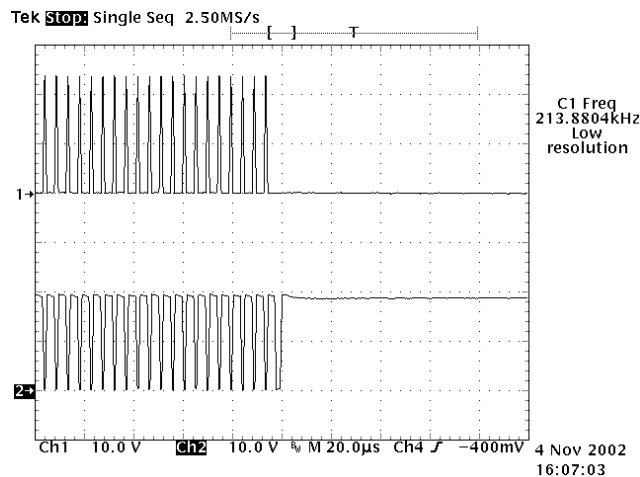

Figure 6 - Soft-Start pin grounded.
 Ch1: HDrv, Ch2: LDrv

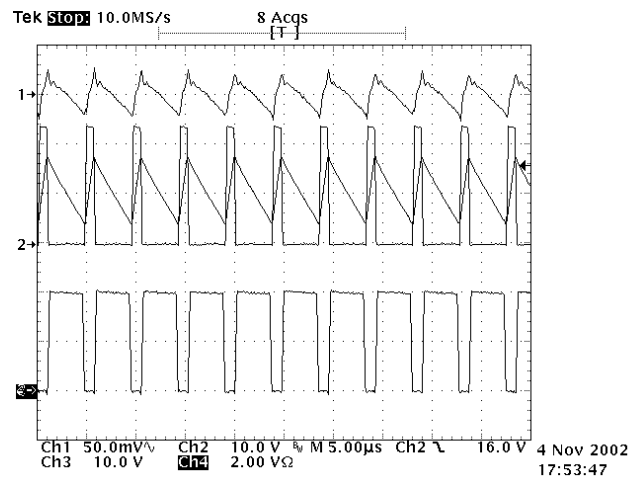

Figure 7 - Output Ripple.
 Ch1: Output Ripple, Ch2: HDrv, Ch3: LDrv,
 Ch4: Inductor Current

TYPICAL OPERATING CHARACTERISTICS

Test Conditions:

$V_{IN}=20V$, $V_{OUT}=3.3V$, $I_{OUT}=0-8A$, $F_s=200KHz$

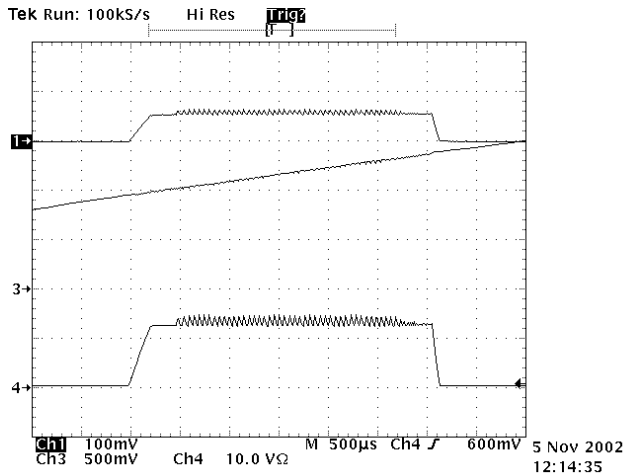

Figure 8 - Output shorted at start up.
Ch1: V_{OUT} , Ch3: V_{ss} , Ch4: Inductor Current

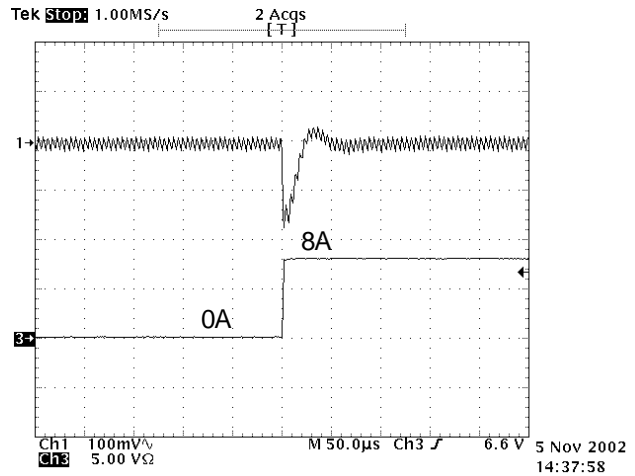

Figure 9 - Load Transient Response
Ch1: V_{OUT} , Ch3: Output Current

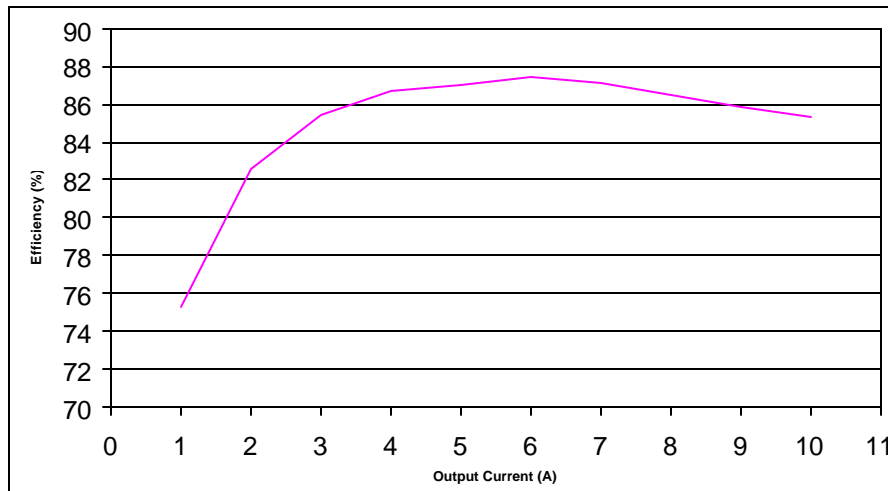

Figure 10 - Efficiency Measurement.
 $V_{IN}=20V$, $V_{OUT}=3.3V$