

IRG4MC30F

INSULATED GATE BIPOLAR TRANSISTOR

Fast Speed IGBT

Features

- Electrically Isolated and Hermetically Sealed
- Simple Drive Requirements
- Latch-proof
- Fast Speed operation 3 kHz - 8 kHz
- High operating frequency
- Switching-loss rating includes all "tail" losses
- Ceramic eyelets

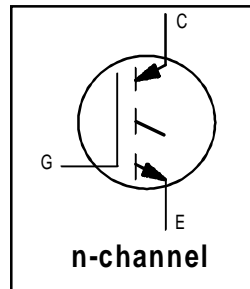

$V_{CES} = 600V$
$V_{CE(on) max} = 1.7V$
@ $V_{GE} = 15V, I_C = 15A$

Benefits

- Generation 4 IGBT's offer highest efficiency available
- IGBT's optimized for specified application conditions
- Designed to be a "drop-in" replacement for equivalent IR Hi-Rel Generation 3 IGBT's

Insulated Gate Bipolar Transistors (IGBTs) from International Rectifier have higher usable current densities than comparable bipolar transistors, while at the same time having simpler gate-drive requirements of the familiar power MOSFET. They provide substantial benefits to a host of high-voltage, high-current applications.

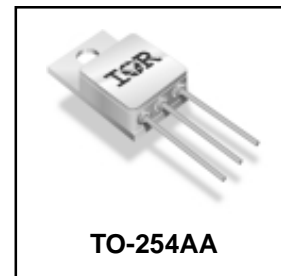

Absolute Maximum Ratings

	Parameter	Max.	Units
V_{CES}	Collector-to-Emitter Breakdown Voltage	600	V
$I_C @ T_C = 25^\circ C$	Continuous Collector Current	28	A
$I_C @ T_C = 100^\circ C$	Continuous Collector Current	15	
I_{CM}	Pulsed Collector Current ①	112	
I_{LM}	Clamped Inductive Load Current ②	112	
V_{GE}	Gate-to-Emitter Voltage	± 20	V
$P_D @ T_C = 25^\circ C$	Maximum Power Dissipation	75	W
$P_D @ T_C = 100^\circ C$	Maximum Power Dissipation	30	
T_J	Operating Junction and Storage Temperature Range	-55 to + 150	$^\circ C$
T_{STG}			
	Lead Temperature	300 (0.063in./1.6mm from case for 10s)	
	Weight	9.3 (typical)	g

Thermal Resistance

	Parameter	Min	Typ	Max	Units	Test Conditions
R_{thJC}	Junction-to-Case	—	—	1.67	$^\circ C/W$	

IRG4MC30F

International
IR Rectifier

Electrical Characteristics @ $T_J = 25^\circ\text{C}$ (unless otherwise specified)

	Parameter	Min.	Typ.	Max.	Units	Conditions
$V_{(BR)CES}$	Collector-to-Emitter Breakdown Voltage	600	—	—	V	$V_{GE} = 0V, I_C = 1.0\text{ mA}$
$V_{(BR)ECS}$	Emitter-to-Collector Breakdown Voltage ③	18	—	—	V	$V_{GE} = 0V, I_C = 1.0\text{ A}$
$\Delta V_{(BR)CES}/\Delta T_J$	Temperature Coeff. of Breakdown Voltage	—	0.63	—	V/°C	$V_{GE} = 0V, I_C = 1.0\text{ mA}$
$V_{CE(ON)}$	Collector-to-Emitter Saturation Voltage	—	—	1.7	V	$I_C = 15A$ $V_{GE} = 15V$ See Fig.2, 5
		—	—	2.2		
		—	—	2.7		
$V_{GE(th)}$	Gate Threshold Voltage	3.0	—	6.0	V	$V_{CE} = V_{GE}, I_C = 1.0\text{ mA}$
$\Delta V_{GE(th)}/\Delta T_J$	Temperature Coeff. of Threshold Voltage	—	-11	—	mV/°C	$V_{CE} = V_{GE}, I_C = 250\text{ }\mu\text{A}$
g_{fe}	Forward Transconductance ④	14	—	—	S	$V_{CE} \geq 15V, I_C = 15A$
I_{CES}	Zero Gate Voltage Collector Current	—	—	50	μA	$V_{GE} = 0V, V_{CE} = 480V$
		—	—	1000		$V_{GE} = 0V, V_{CE} = 480V, T_J = 125^\circ\text{C}$
I_{GES}	Gate-to-Emitter Leakage Current	—	—	± 100	nA	$V_{GE} = \pm 20V$

Switching Characteristics @ $T_J = 25^\circ\text{C}$ (unless otherwise specified)

	Parameter	Min.	Typ.	Max.	Units	Conditions
Q_g	Total Gate Charge (turn-on)	—	—	77	nC	$I_C = 15A$ $V_{CC} = 300V$ $V_{GE} = 15V$ See Fig. 8
Q_{ge}	Gate - Emitter Charge (turn-on)	—	—	12		
Q_{gc}	Gate - Collector Charge (turn-on)	—	—	24		
$t_{d(on)}$	Turn-On Delay Time	—	—	42	ns	$T_J = 25^\circ\text{C}$ $I_C = 15A, V_{CC} = 480V$ $V_{GE} = 15V, R_G = 7.5\Omega$ Energy losses include "tail"
t_r	Rise Time	—	—	30		
$t_{d(off)}$	Turn-Off Delay Time	—	—	300		
t_f	Fall Time	—	—	300		
E_{ts}	Total Switching Loss	—	—	2.0	mJ	See Fig. 10, 11, 13, 14
$t_{d(on)}$	Turn-On Delay Time	—	—	25	ns	$T_J = 125^\circ\text{C}$, $I_C = 15A, V_{CC} = 480V$ $V_{GE} = 15V, R_G = 7.5\Omega$ Energy losses include "tail"
t_r	Rise Time	—	—	20		
$t_{d(off)}$	Turn-Off Delay Time	—	—	450		
t_f	Fall Time	—	—	550		
E_{ts}	Total Switching Loss	—	—	3.0	mJ	See Fig. 13, 14
L_C+L_E	Total Inductance	—	6.8	—	nH	Measured from Collector lead (6mm/ 0.25in. from package) to Emitter lead (6mm / 0.25in. from package)
C_{ies}	Input Capacitance	—	1100	—	pF	$V_{GE} = 0V$ $V_{CC} = 30V$ $f = 1.0\text{ MHz}$ See Fig. 7
C_{oes}	Output Capacitance	—	74	—		
C_{res}	Reverse Transfer Capacitance	—	14	—		

Notes:

- ① Repetitive rating; $V_{GE} = 20V$, pulse width limited by max. junction temperature. (See fig. 13b)
- ② $V_{CC} = 80\%(V_{CES}), V_{GE} = 20V, L = 100\mu\text{H}, R_G = 7.5\Omega$, (See fig. 13a)
- ③ Pulse width $\leq 80\mu\text{s}$; duty factor $\leq 0.1\%$.
- ④ Pulse width $5.0\mu\text{s}$, single shot.

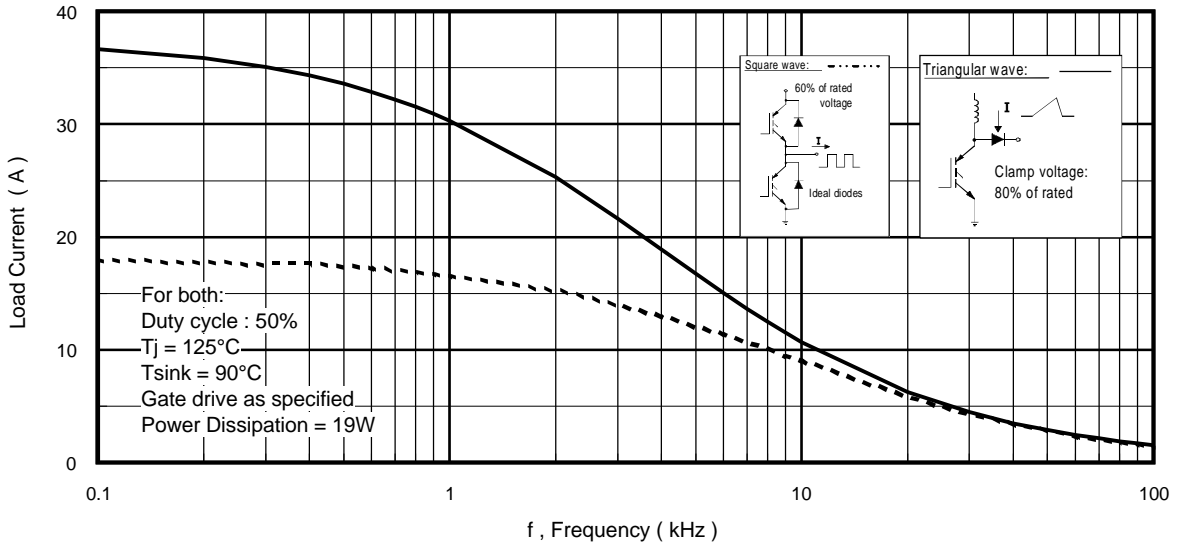

Fig. 1 - Typical Load Current vs. Frequency
(For square wave, $I = I_{\text{RMS}}$ of fundamental; for triangular wave, $I = I_{\text{PK}}$)

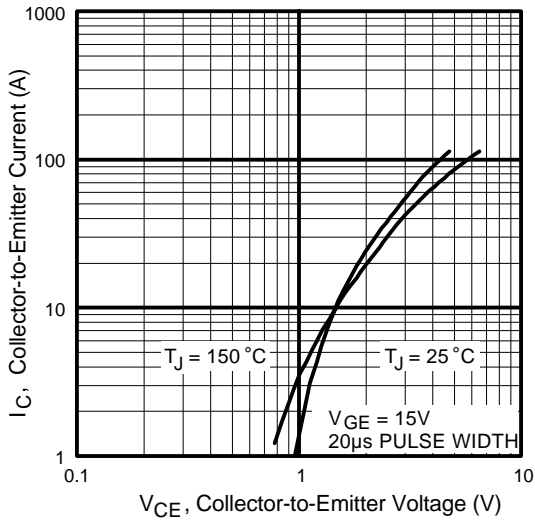

Fig. 2 - Typical Output Characteristics

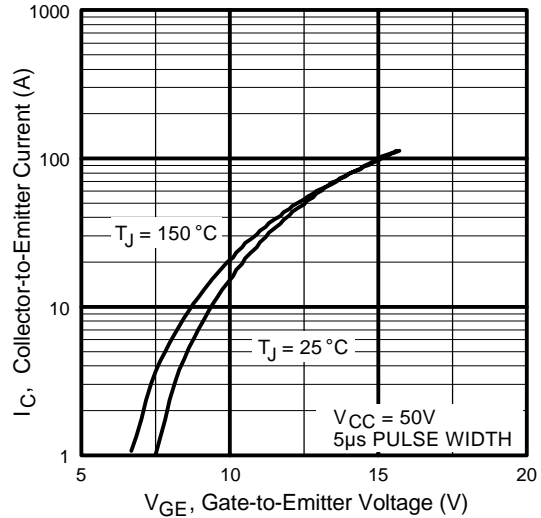

Fig. 3 - Typical Transfer Characteristics

IRG4MC30F

International
IRF Rectifier

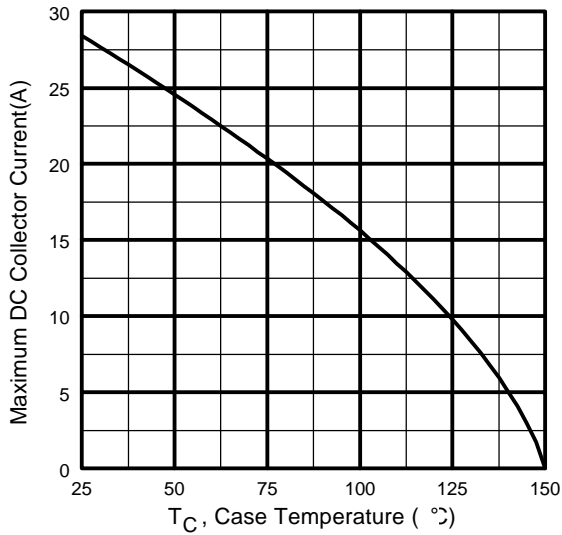

Fig. 4 - Maximum Collector Current vs. Case Temperature

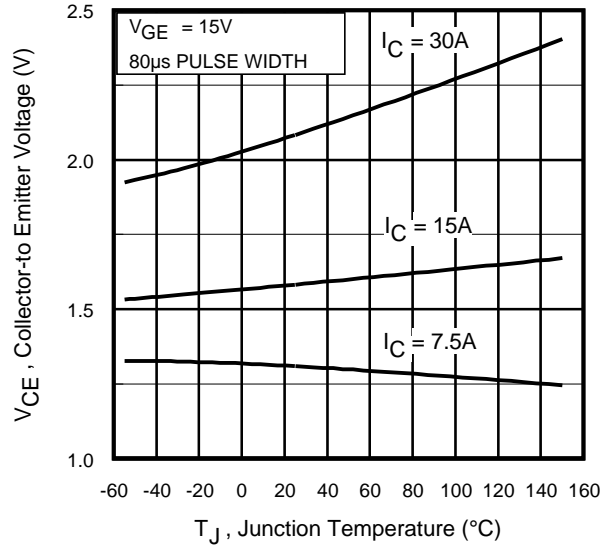

Fig. 5 - Collector-to-Emitter Voltage vs. Junction Temperature

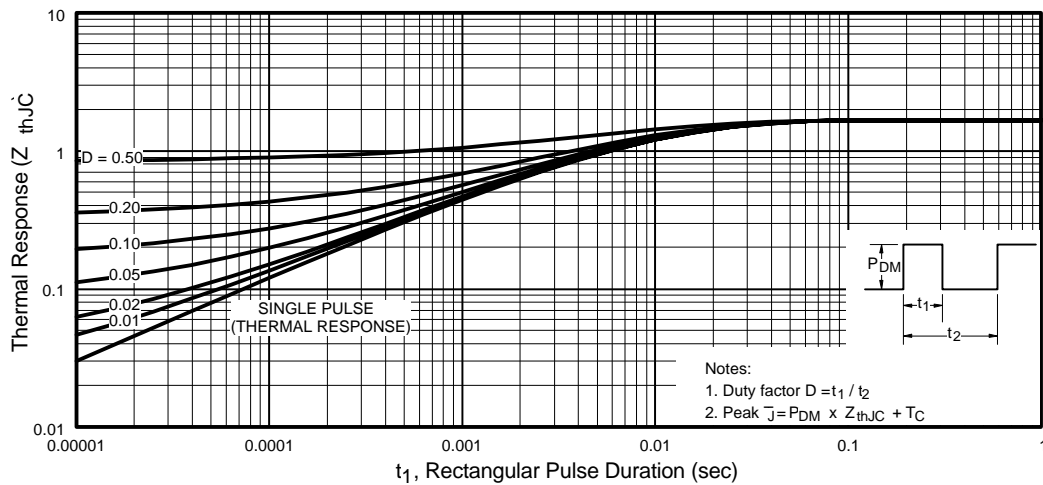

Fig. 6 - Maximum Effective Transient Thermal Impedance, Junction-to-Case

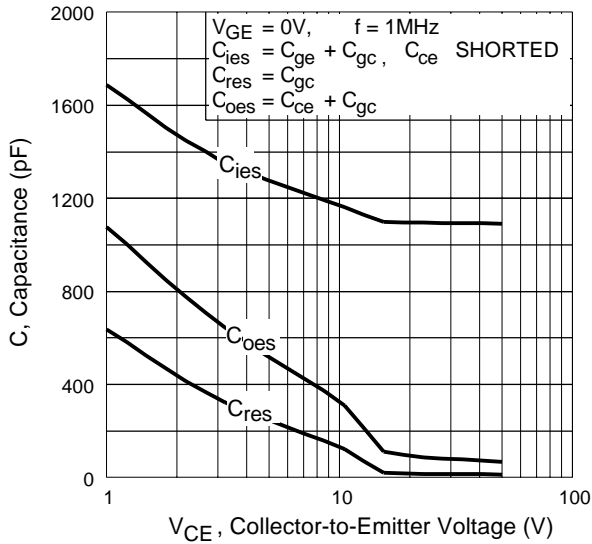

Fig. 7 - Typical Capacitance vs. Collector-to-Emitter Voltage

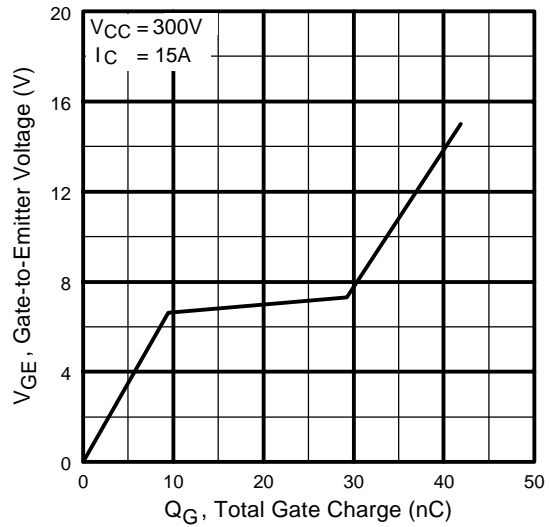

Fig. 8 - Typical Gate Charge vs. Gate-to-Emitter Voltage

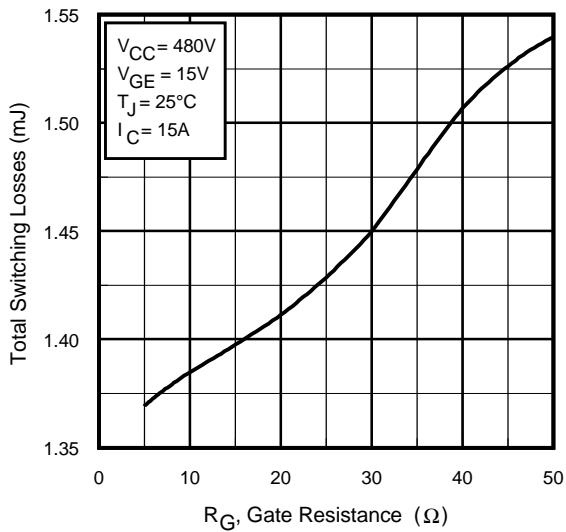

Fig. 9 - Typical Switching Losses vs. Gate Resistance

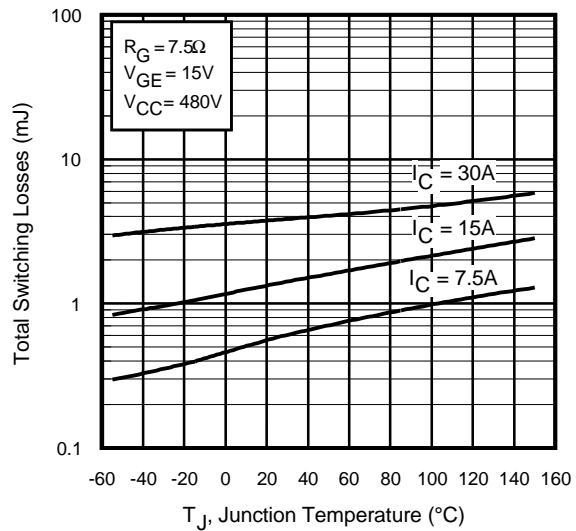

Fig. 10 - Typical Switching Losses vs. Junction Temperature

IRG4MC30F

International
IR Rectifier

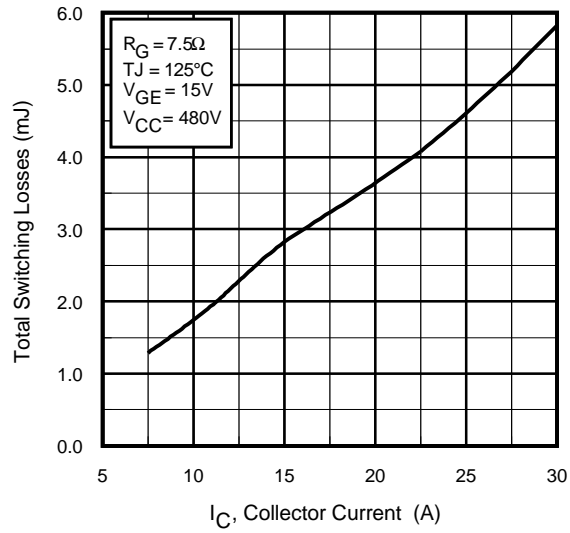

Fig. 11 - Typical Switching Losses vs. Collector-to-Emitter Current

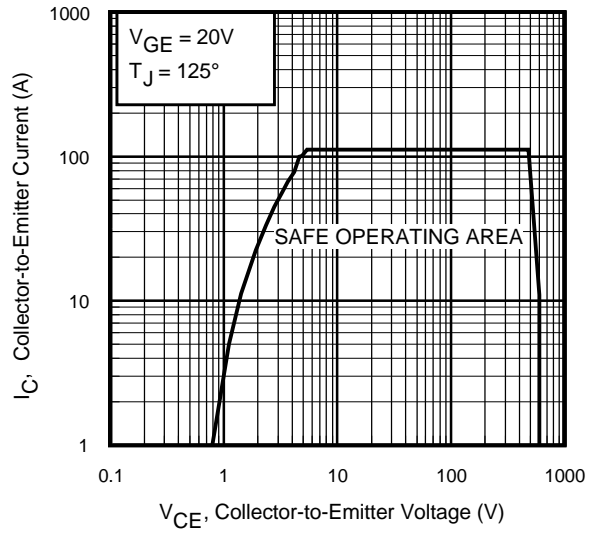

Fig. 12 - Turn-Off SOA



* Driver same type as D.U.T.; $V_c = 80\%$ of $V_{ce(max)}$
 * Note: Due to the 50V power supply, pulse width and inductor will increase to obtain rated I_d .

Fig. 13a - Clamped Inductive Load Test Circuit

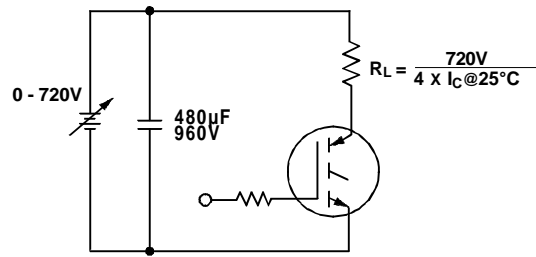

Fig. 13b - Pulsed Collector Current Test Circuit



Fig. 14a - Switching Loss Test Circuit

* Driver same type as D.U.T., $V_C = 720V$

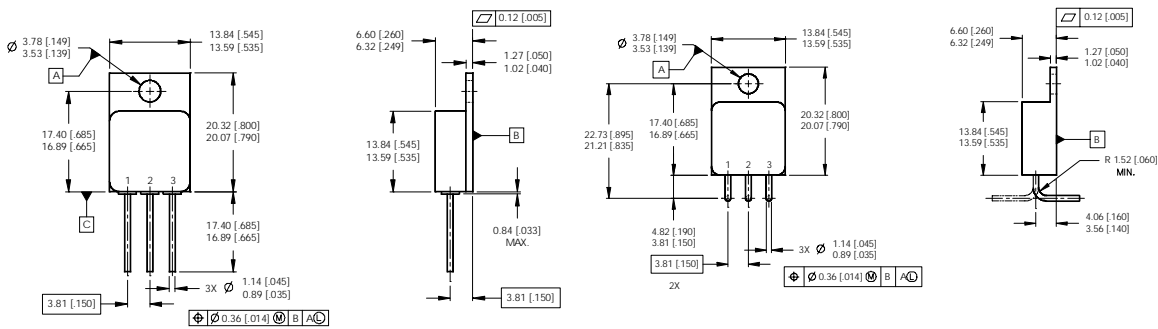

Fig. 14b - Switching Loss Waveforms

IRG4MC30F

International
IR Rectifier

Case Outline and Dimensions — TO-254AA



NOTES:

1. DIMENSIONING & TOLERANCING PER ASME Y14.5M-1994.
2. ALL DIMENSIONS ARE SHOWN IN MILLIMETERS [INCHES].
3. CONTROLLING DIMENSION: INCH.
4. CONFIRMS TO JEDEC OUTLINE TO-254AA

PIN ASSIGNMENTS

- 1=COLLECTOR
- 2=EMITTER
- 3=GATE

CAUTION

BERYLLIA WARNING PER MIL-PRF-19500

Packages containing beryllia shall not be ground, sandblasted, machined, or have other operations performed on them which will produce beryllia or beryllium dust. Furthermore, beryllium oxide packages shall not be placed in acids that will produce fumes containing beryllium.

International
IR Rectifier

IR WORLD HEADQUARTERS: 233 Kansas St., El Segundo, California 90245, USA Tel: (310) 252-7105
TAC Fax: (310) 252-7903

Visit us at www.irf.com for sales contact information.

Data and specifications subject to change without notice. 02/02