

# Hyper Multi TOPLED Hyper-Bright LED

## LATB T686



### Vorläufige Daten / Preliminary Data

#### Besondere Merkmale

- **Gehäusetypp:** weißes P-LCC-4 Gehäuse; Kontrasterhöhung durch schwarze Oberfläche (RGB-Displays)
- **Besonderheit des Bauteils:** additive Farbmischung durch unabhängige Ansteuerung aller Chips
- **Wellenlänge:** 615 nm (amber), 528 nm (true green), 467 nm (blau)
- **Abstrahlwinkel:** Lambertischer Strahler (120°)
- **Technologie:** InGaAIP (amber), InGaN (true green), GaN (blau)
- **optischer Wirkungsgrad:** 11 lm/W (amber), 8 lm/W (true green), 1 lm/W (blau)
- **Gruppierungsparameter:** Lichtstärke
- **Verarbeitungsmethode:** für alle SMT-Bestücktechniken geeignet
- **Lötmethode:** IR Reflow Löten und Wellenlöten (TTW)
- **Vorbehandlung:** nach JEDEC Level 2
- **Gurtung:** 8 mm Gurt mit 2000/Rolle,  $\varnothing$ 180 mm oder 8000/Rolle,  $\varnothing$ 330 mm

#### Anwendungen

- Anzeigen im Innen- und Außenbereich (z.B. Grafikdisplays)
- Leuchtdiodenchips getrennt ansteuerbar
- Vollfarbdisplays bzw. RGB-Displays
- Hinterleuchtung (LCD, Schalter, Tasten, Displays, Werbebeleuchtung, Allgemeinbeleuchtung)
- Einkopplung in Lichtleiter

#### Features

- **package:** white P-LCC-4 package; higher contrast by a black surface (RGB-Displays)
- **feature of the device:** additive mixture of color stimuli by independent driving of each chip
- **wavelength:** 615 nm (amber), 528 nm (true green), 467 nm (blue)
- **viewing angle:** Lambertian Emitter (120°)
- **technology:** InGaAIP (amber), InGaN (true green), GaN (blue)
- **optical efficiency:** 11 lm/W (amber), 8 lm/W (true green), 1 lm/W (blue)
- **grouping parameter:** luminous intensity
- **assembly methods:** suitable for all SMT assembly methods
- **soldering methods:** IR reflow soldering and TTW soldering
- **preconditioning:** acc. to JEDEC Level 2
- **taping:** 8 mm tape with 2000/reel,  $\varnothing$ 180 mm or 8000/reel,  $\varnothing$ 330 mm

#### Applications

- indoor and outdoor displays (e.g. graphic displays)
- LED chips can be controlled separately
- full color displays, RGB-Displays
- backlighting (LCD, switches, keys, displays, illuminated advertising, general lighting)
- coupling into light guides

Typ  Type	Emissions -farbe  Color of Emission	Farbe der Lichtaustritts- fläche Color of the Light Emitting Area	Lichtstärke  Luminous Intensity $I_F = 20 \text{ mA}$ $I_V \text{ (mcd)}$			Bestell- nummer  Ordering Code
			amber	true green	blue	
			LATB T686 Q+R+K Q+R+L Q+S+K Q+S+L R+R+K R+R+L R+S+K R+S+L	amber true green blue	colorless clear and black painted package surface	

Helligkeitswerte werden mit einer Stromeinprägedauer von 25 ms und einer Genauigkeit von  $\pm 11 \%$  ermittelt.  
Luminous intensity is tested at a current pulse duration of 25 ms and a tolerance of  $\pm 11 \%$ .

*Anm.: Die Standardlieferform von Serientypen beinhaltet eine Familiengruppe. Einzelne Gruppen sind nicht erhältlich.*

*In einer Verpackungseinheit / Gurt ist immer nur eine Gruppe pro Farbe enthalten.*

*Note: The standard shipping format for serial types includes a family group. Individual groups are not available.*

*No packing unit / tape ever contains more than one luminous intensity group per color.*

**Grenzwerte**  
**Maximum Ratings**

Bezeichnung Parameter	Symbol Symbol	Werte Values			Einheit Unit
		LA	LT	LB	
Betriebstemperatur Operating temperature range	$T_{op}$	- 40 ... + 100			°C
Lagertemperatur Storage temperature range	$T_{stg}$	- 40 ... + 100			°C
Sperrschichttemperatur Junction temperature	$T_j$	+ 125	+ 125	+ 100	°C
Durchlassstrom Forward current	$I_F$	30	20	20	mA
Stoßstrom Surge current $t_p = 10 \mu s, D = 0.005$	$I_{FM}$	1.00	0.25	0.20	A
Sperrspannung Reverse voltage	$V_R$	3	5	5	V
Leistungsaufnahme Power consumption	$P_{tot}$	80	85	90	mW
Wärmewiderstand Thermal resistance					
Sperrschicht/Umgebung Junction/ambient	1 chip on $R_{th JA}$	580	480	580	K/W
	3 chips on $R_{th JA}$	825	770	825	K/W
Sperrschicht/Löt看垫 Junction/solder point	1 chip on $R_{th JS}$	340	260	340	K/W
	3 chips on $R_{th JS}$	490	420	490	K/W
Montage auf PC-Board FR 4 (Padgröße $\geq 16 \text{ mm}^2$ ) mounted on PC board FR 4 (pad size $\geq 16 \text{ mm}^2$ )					

Kennwerte ( $T_A = 25\text{ °C}$ )

## Characteristics

Bezeichnung Parameter	Symbol Symbol	Werte Values			Einheit Unit
		LA	LT	LB	
Wellenlänge des emittierten Lichtes (typ.) Wavelength at peak emission $I_F = 20\text{ mA}$	$\lambda_{\text{peak}}$	622	523	428	nm
Dominantwellenlänge <sup>1)</sup> (typ.) Dominant wavelength <sup>1)</sup> $I_F = 20\text{ mA}$	$\lambda_{\text{dom}}$	617 $\pm 5$	528 $\pm 9$	467 $\pm 5$	nm
Spektrale Bandbreite bei 50 % $I_{\text{rel max}}$ (typ.) Spectral bandwidth at 50 % $I_{\text{rel max}}$ $I_F = 20\text{ mA}$	$\Delta\lambda$	16	33	60	nm
Abstrahlwinkel bei 50 % $I_V$ (Vollwinkel) (typ.) Viewing angle at 50 % $I_V$	$2\phi$	120	120	120	Grad deg.
Durchlassspannung <sup>2)</sup> (typ.) Forward voltage <sup>2)</sup> (max.) $I_F = 20\text{ mA}$	$V_F$ <sup>2)</sup> $V_F$	2.0 2.4	3.3 4.1	3.8 4.1	V V
Sperrstrom (typ.) Reverse current (max.) $V_R = 5\text{ V}$	$I_R$ $I_R$	0.01 10	0.01 10	0.01 10	$\mu\text{A}$ $\mu\text{A}$
Temperaturkoeffizient von $\lambda_{\text{peak}}$ (typ.) Temperature coefficient of $\lambda_{\text{peak}}$ $I_F = 20\text{ mA}; -10\text{ °C} \leq T \leq 100\text{ °C}$	$TC_{\lambda_{\text{peak}}}$	0.13	0.04	0.004	nm/K
Temperaturkoeffizient von $\lambda_{\text{dom}}$ (typ.) Temperature coefficient of $\lambda_{\text{dom}}$ $I_F = 20\text{ mA}; -10\text{ °C} \leq T \leq 100\text{ °C}$	$TC_{\lambda_{\text{dom}}}$	0.06	0.03	0.03	nm/K
Temperaturkoeffizient von $V_F$ (typ.) Temperature coefficient of $V_F$ $I_F = 20\text{ mA}; -10\text{ °C} \leq T \leq 100\text{ °C}$	$TC_V$	- 1.8	- 3.6	- 3.1	mV/K
Optischer Wirkungsgrad (typ.) Optical efficiency $I_F = 20\text{ mA}$	$\eta_{\text{opt}}$	11	8	1	lm/W

<sup>1)</sup> Wellenlängen werden mit einer Stromeinprägungsdauer von 25 ms und einer Genauigkeit von  $\pm 1\text{ nm}$  ermittelt.  
Wavelengths are tested at a current pulse duration of 25 ms and a tolerance of  $\pm 1\text{ nm}$ .

<sup>2)</sup> Durchlassspannungen werden mit einer Stromeinprägungsdauer von 1 ms und einer Genauigkeit von  $\pm 0,1\text{ V}$  ermittelt.  
Forward voltages are tested at a current pulse duration of 1 ms and a tolerance of  $\pm 0.1\text{ V}$ .

Relative spektrale Emission  $I_{rel} = f(\lambda)$ ,  $T_A = 25\text{ °C}$ ,  $I_F = 20\text{ mA}$

**Relative Spectral Emission**

$V(\lambda)$  = spektrale Augenempfindlichkeit

Standard eye response curve

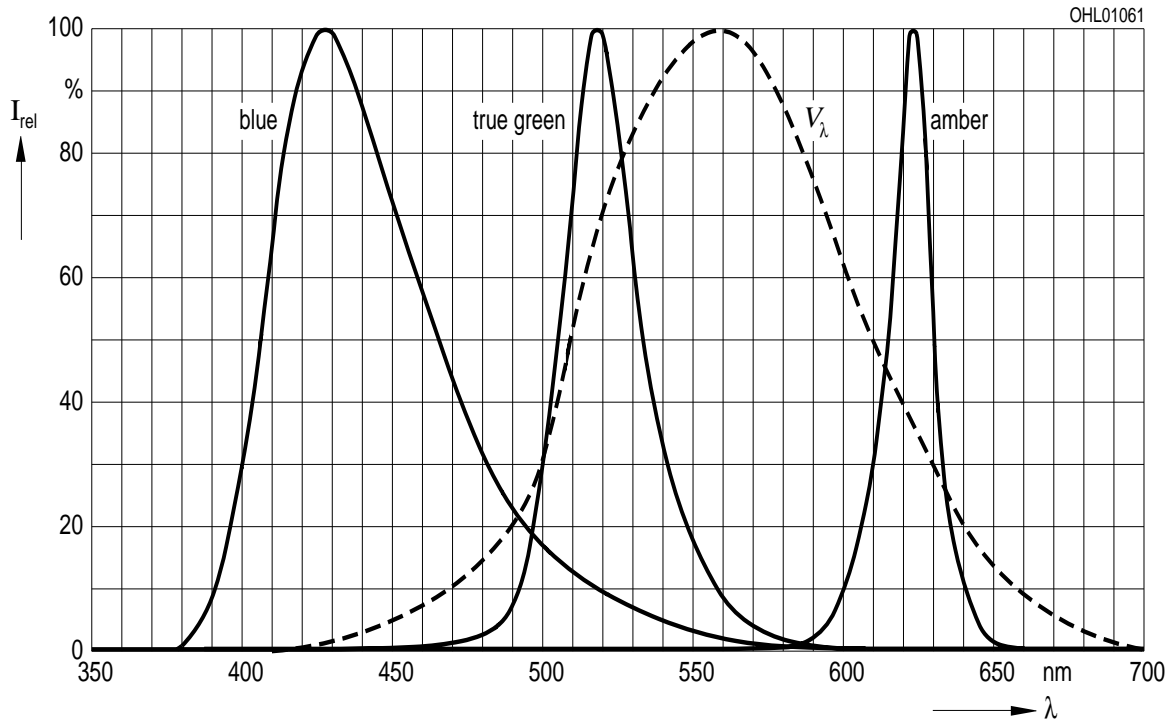

Abstrahlcharakteristik  $I_{rel} = f(\varphi)$

**Radiation Characteristic**

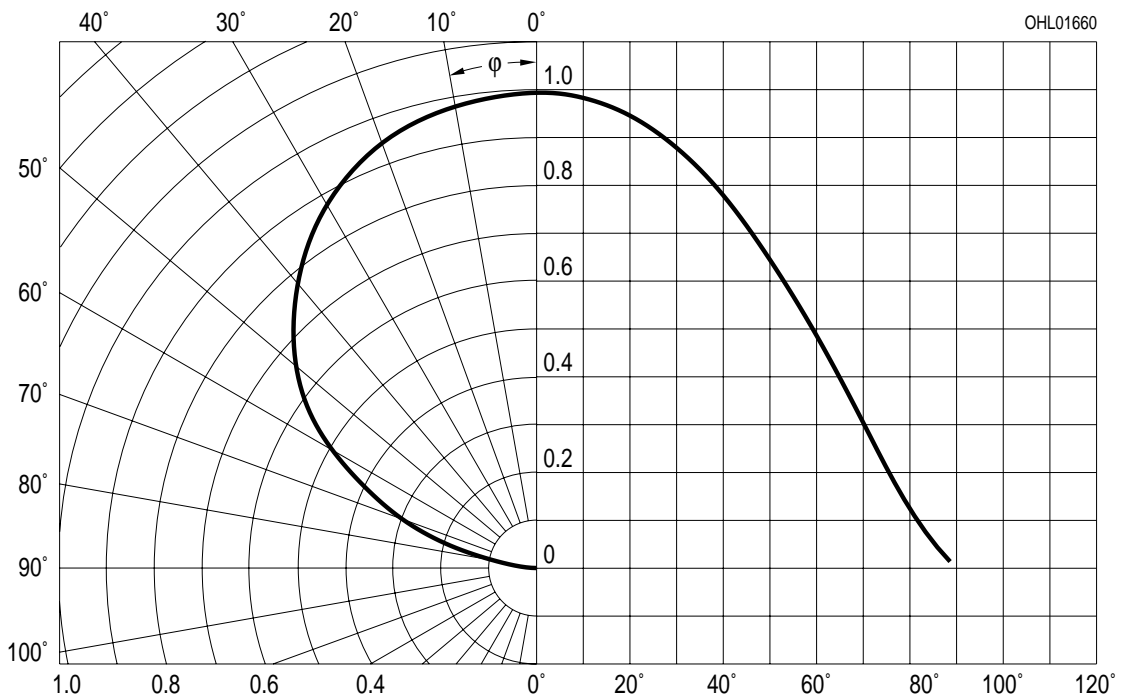

**Durchlassstrom  $I_F = f(V_F)$**   
**Forward Current**

$T_A = 25\text{ °C}$

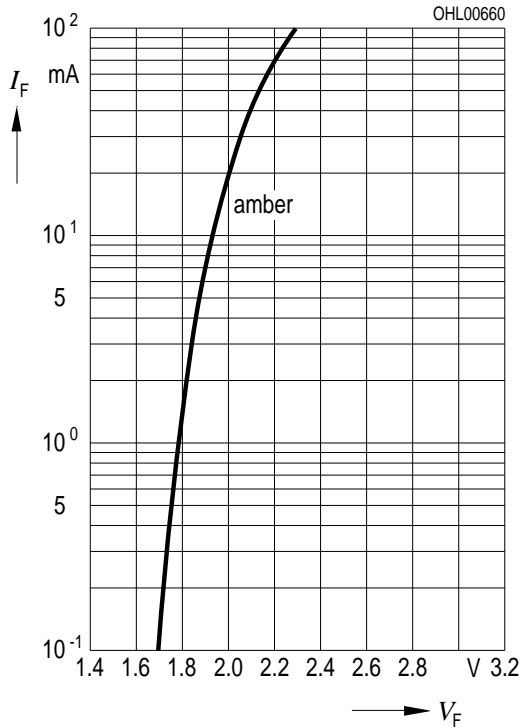

**Relative Lichtstärke  $I_V/I_{V(20\text{ mA})} = f(I_F)$**   
**Relative Luminous Intensity**

$T_A = 25\text{ °C}$

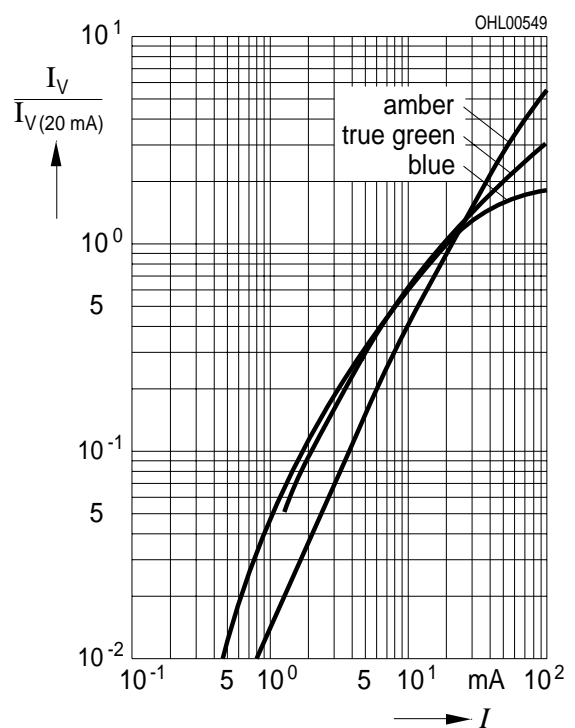

**Durchlassstrom  $I_F = f(V_F)$**   
**Forward Current**

$T_A = 25\text{ °C}$

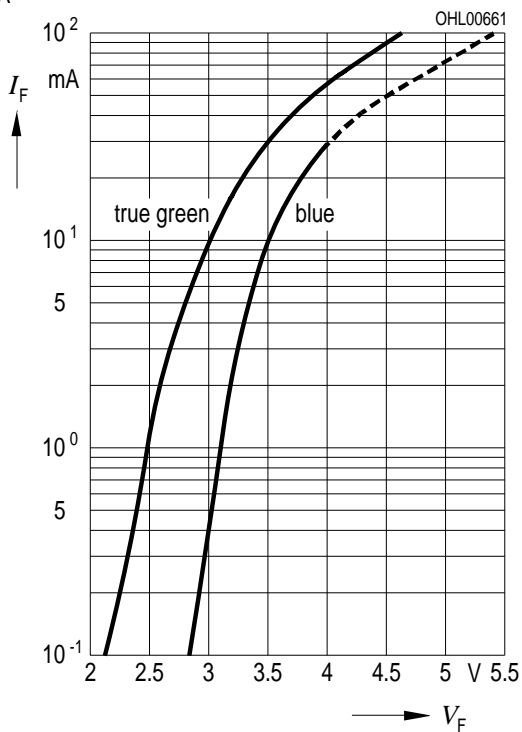

**Relative Lichtstärke  $I_V/I_{V(25\text{ °C})} = f(T_A)$**   
**Relative Luminous Intensity**

$I_F = 20\text{ mA}$

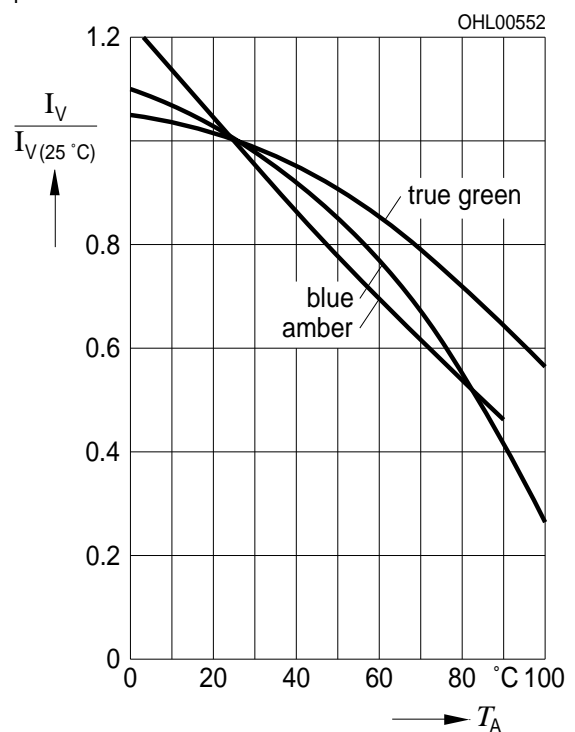

**Maximal zulässiger Durchlassstrom  $I_F = f(T)$**   
**Max. Permissible Forward Current**  
 1 chip on

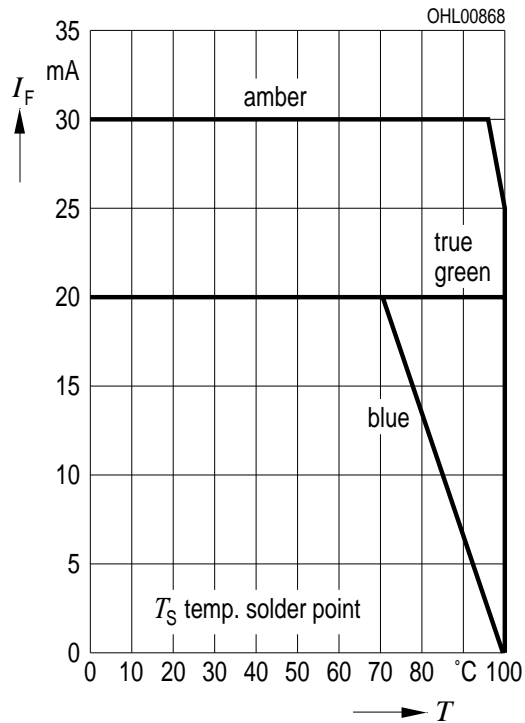

**Maximal zulässiger Durchlassstrom  $I_F = f(T)$**   
**Max. Permissible Forward Current**  
 3 chips on

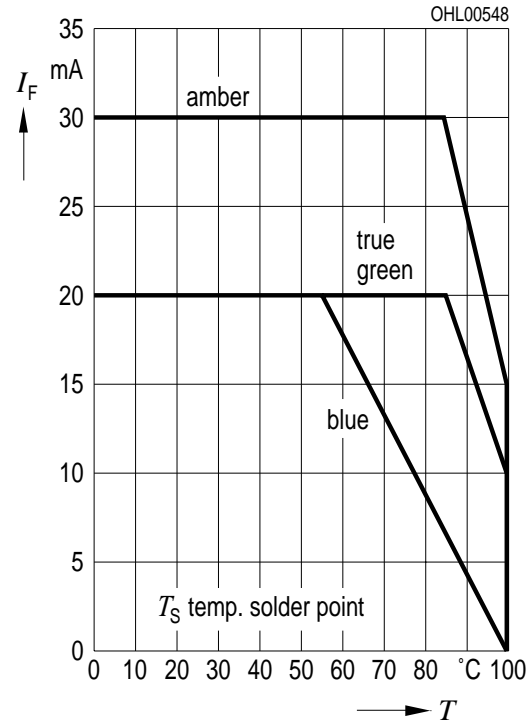

**Maximal zulässiger Durchlassstrom  $I_F = f(T)$**   
**Max. Permissible Forward Current**  
 1 chip on

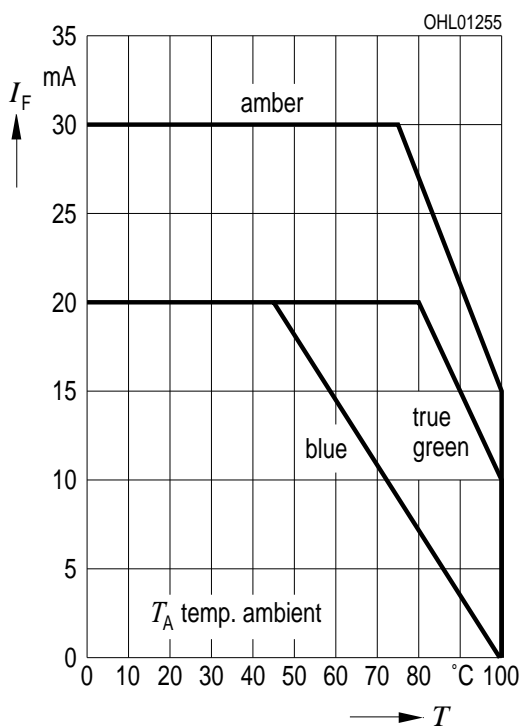

**Maximal zulässiger Durchlassstrom  $I_F = f(T)$**   
**Max. Permissible Forward Current**  
 3 chips on

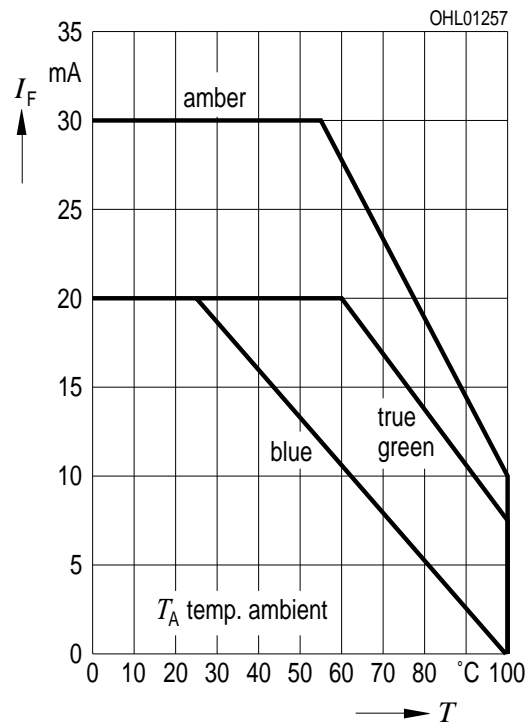

**Zulässige Impulsbelastbarkeit  $I_F = f(t_p)$**   
**Permissible Pulse Handling Capability**  
 Duty cycle  $D =$  parameter,  $T_A = 25\text{ °C}$   
**amber (1 Chip on)**

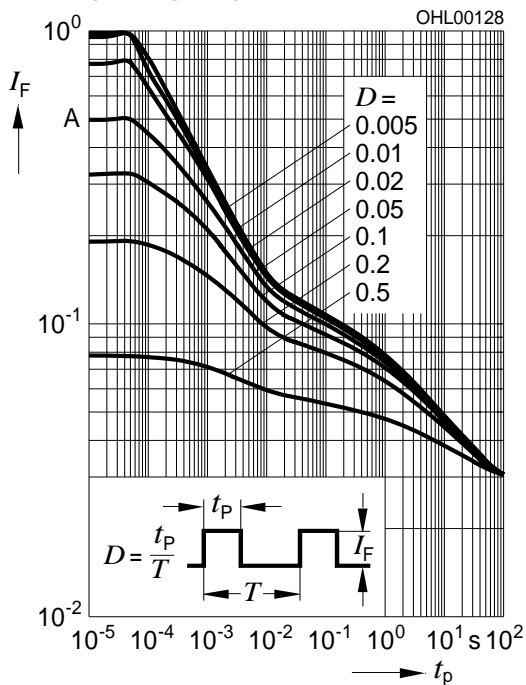

**Zulässige Impulsbelastbarkeit  $I_F = f(t_p)$**   
**Permissible Pulse Handling Capability**  
 Duty cycle  $D =$  parameter,  $T_A = 85\text{ °C}$   
**amber (1Chip on)**

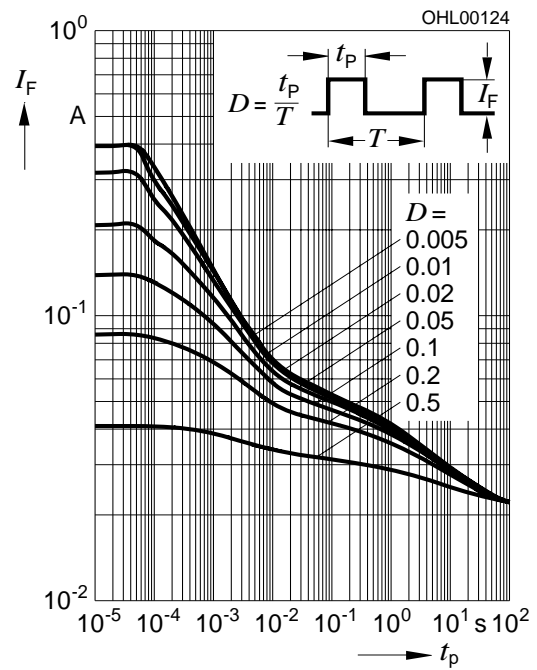

**Zulässige Impulsbelastbarkeit  $I_F = f(t_p)$**   
**Permissible Pulse Handling Capability**  
 Duty cycle  $D =$  parameter,  $T_A = 25\text{ °C}$   
**amber (3 Chips on)**

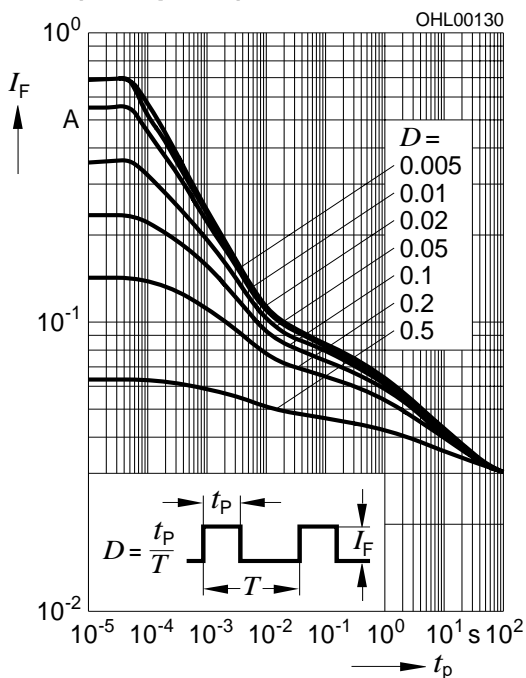

**Zulässige Impulsbelastbarkeit  $I_F = f(t_p)$**   
**Permissible Pulse Handling Capability**  
 Duty cycle  $D =$  parameter,  $T_A = 85\text{ °C}$   
**amber (3 Chips on)**

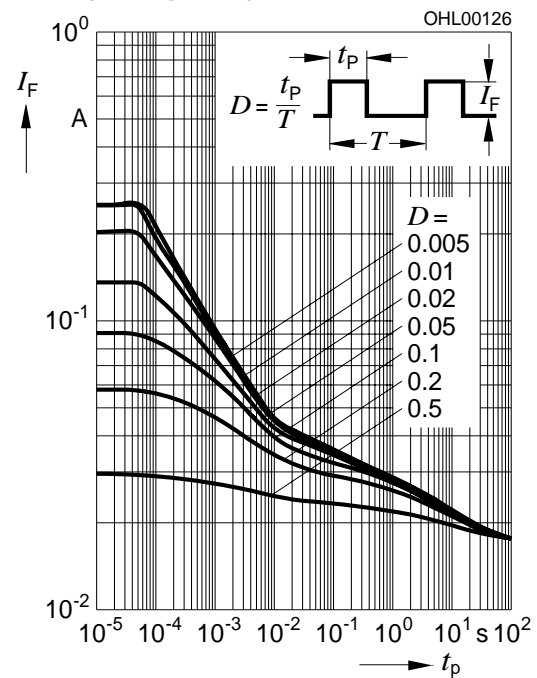



**Zulässige Impulsbelastbarkeit  $I_F = f(t_p)$**   
**Permissible Pulse Handling Capability**  
 Duty cycle  $D =$  parameter,  $T_A = 25\text{ °C}$   
 true green (1 Chip on)

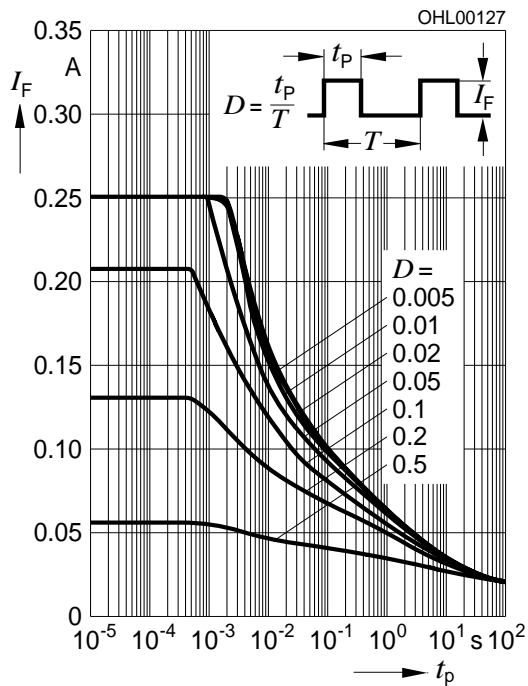

**Zulässige Impulsbelastbarkeit  $I_F = f(t_p)$**   
**Permissible Pulse Handling Capability**  
 Duty cycle  $D =$  parameter,  $T_A = 85\text{ °C}$   
 true green (1 Chip on)

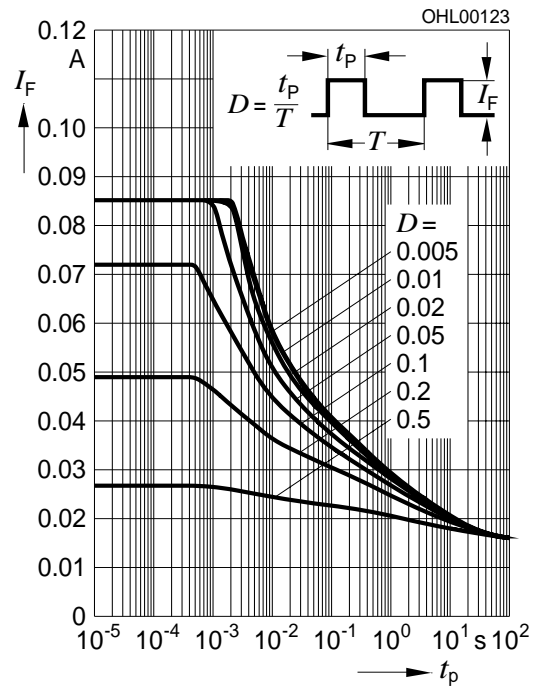

**Zulässige Impulsbelastbarkeit  $I_F = f(t_p)$**   
**Permissible Pulse Handling Capability**  
 Duty cycle  $D =$  parameter,  $T_A = 25\text{ °C}$   
 true green (3 Chips on)

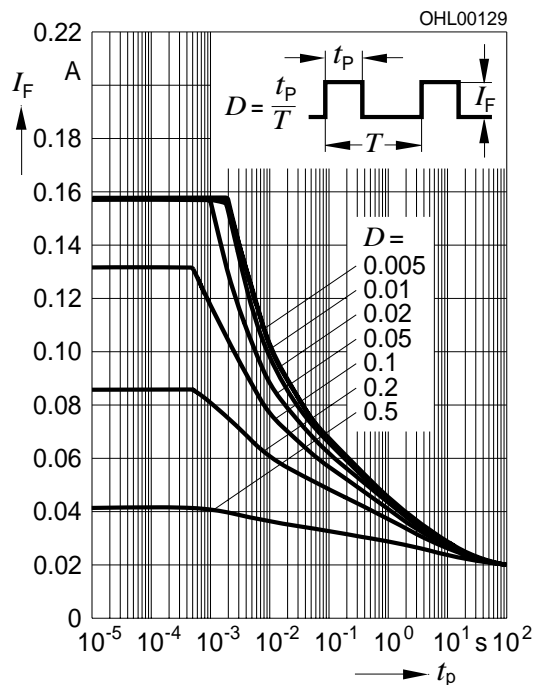

**Zulässige Impulsbelastbarkeit  $I_F = f(t_p)$**   
**Permissible Pulse Handling Capability**  
 Duty cycle  $D =$  parameter,  $T_A = 85\text{ °C}$   
 true green (3 Chips on)

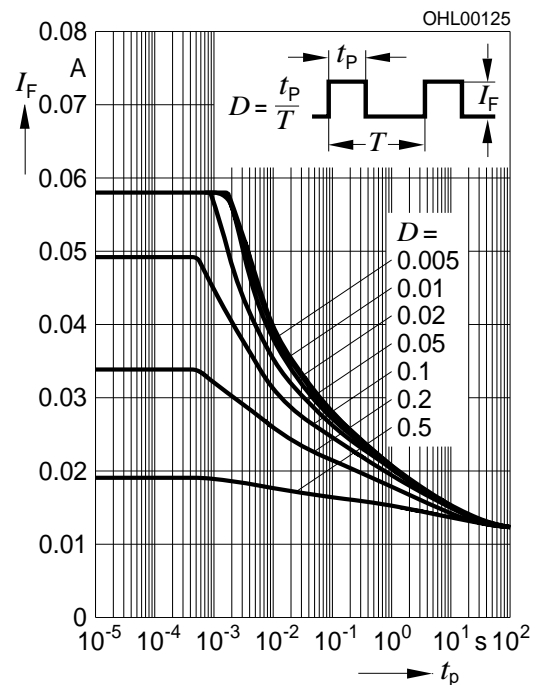

**Zulässige Impulsbelastbarkeit  $I_F = f(t_p)$**   
**Permissible Pulse Handling Capability**  
 Duty cycle  $D =$  parameter,  $T_A = 25\text{ °C}$   
 blue (1 Chip on)

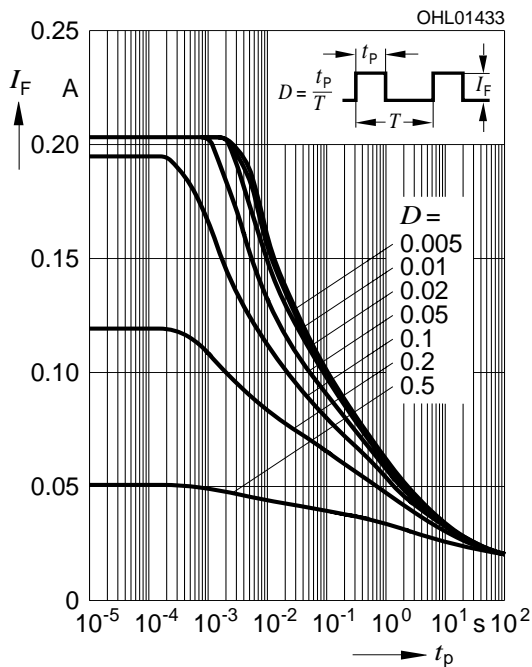

**Zulässige Impulsbelastbarkeit  $I_F = f(t_p)$**   
**Permissible Pulse Handling Capability**  
 Duty cycle  $D =$  parameter,  $T_A = 85\text{ °C}$   
 blue (1 Chip on)

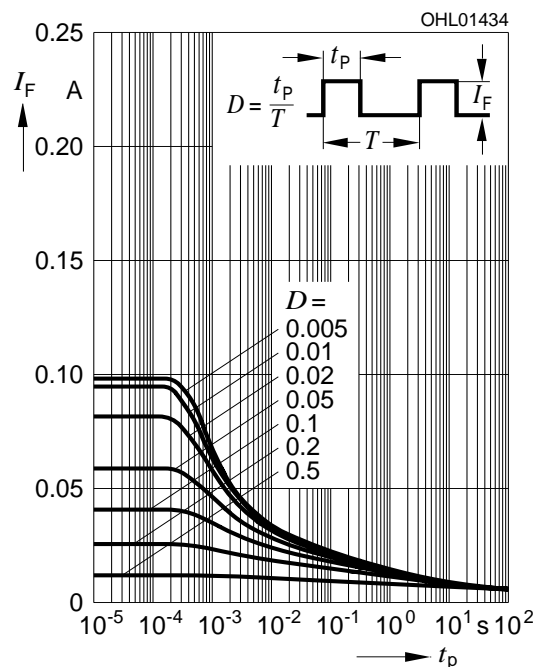

**Zulässige Impulsbelastbarkeit  $I_F = f(t_p)$**   
**Permissible Pulse Handling Capability**  
 Duty cycle  $D =$  parameter,  $T_A = 25\text{ °C}$   
 blue (3 Chips on)

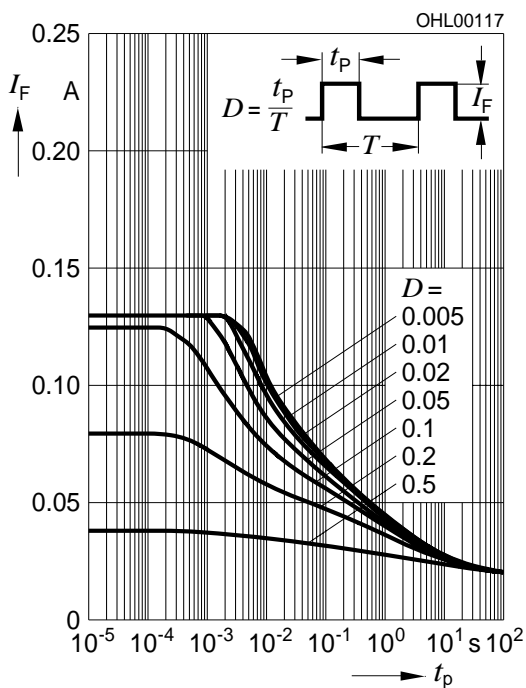

**Zulässige Impulsbelastbarkeit  $I_F = f(t_p)$**   
**Permissible Pulse Handling Capability**  
 Duty cycle  $D =$  parameter,  $T_A = 85\text{ °C}$   
 blue (3 Chips on)

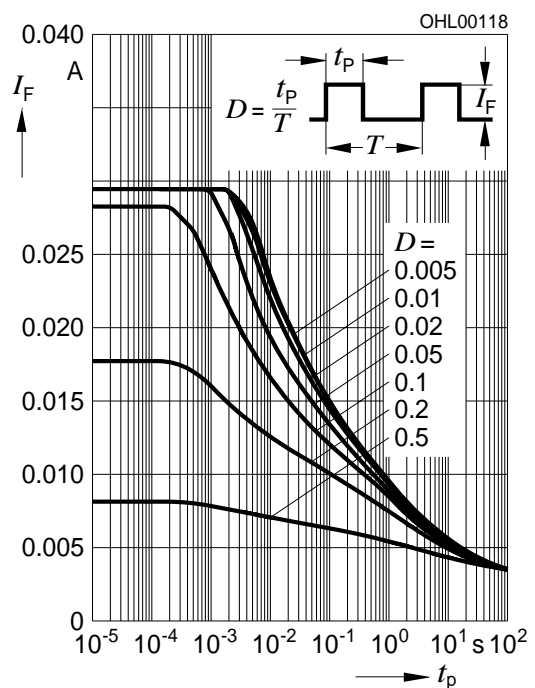

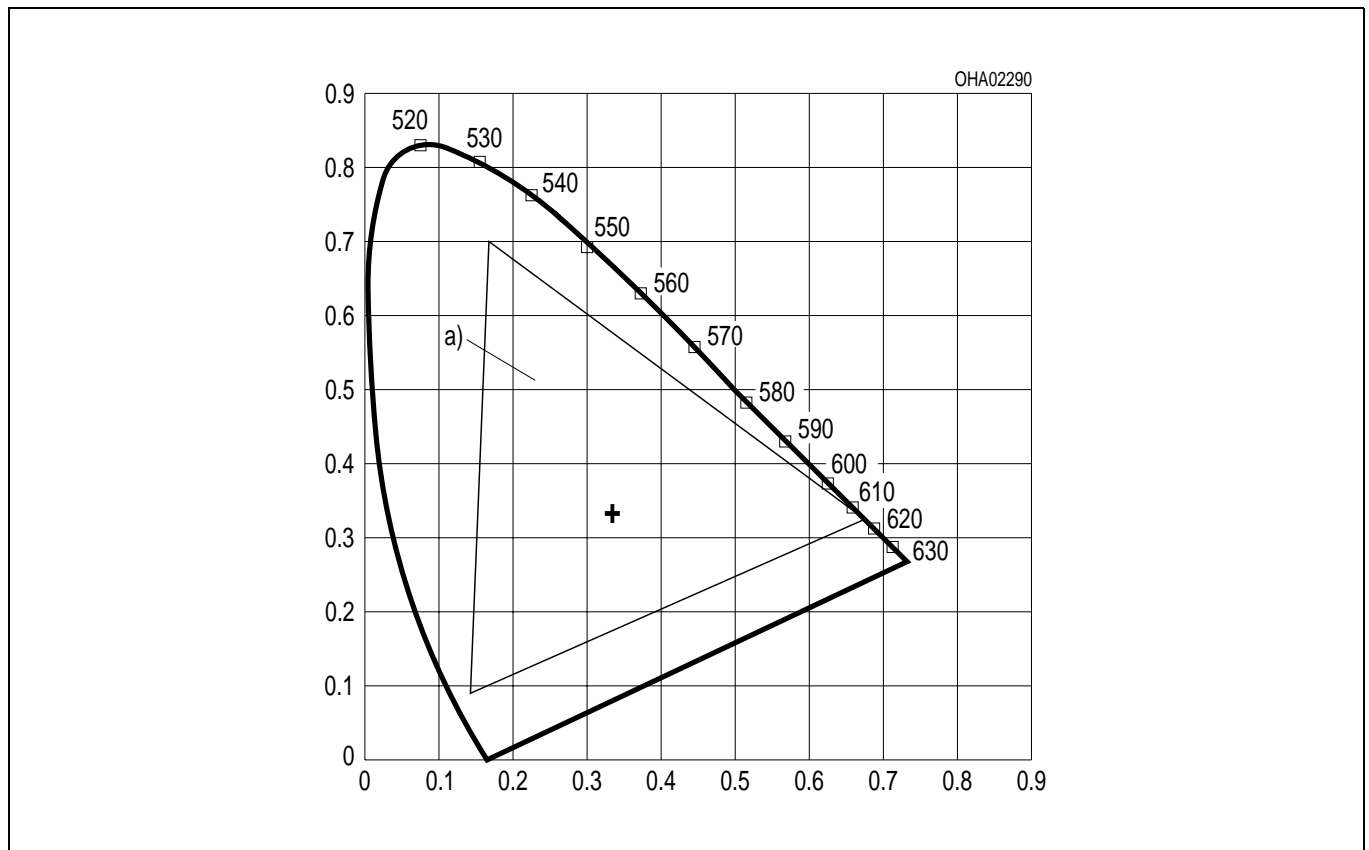

Die Farbkoordinaten des Mischlichtes können innerhalb des mit a) gekennzeichneten Bereichs des Farbdreiecks erwartet werden.

Der Unbuntpunkt ( $x = 0,33$ ,  $y = 0,33$ ) ist mit „+“ gekennzeichnet.

The color coordinates of the mixed light can be expected within the area of the color triangle marked a).

The achromatic point ( $x = 0.33$ ,  $y = 0.33$ ) is marked „+“.

## Maßzeichnung Package Outlines

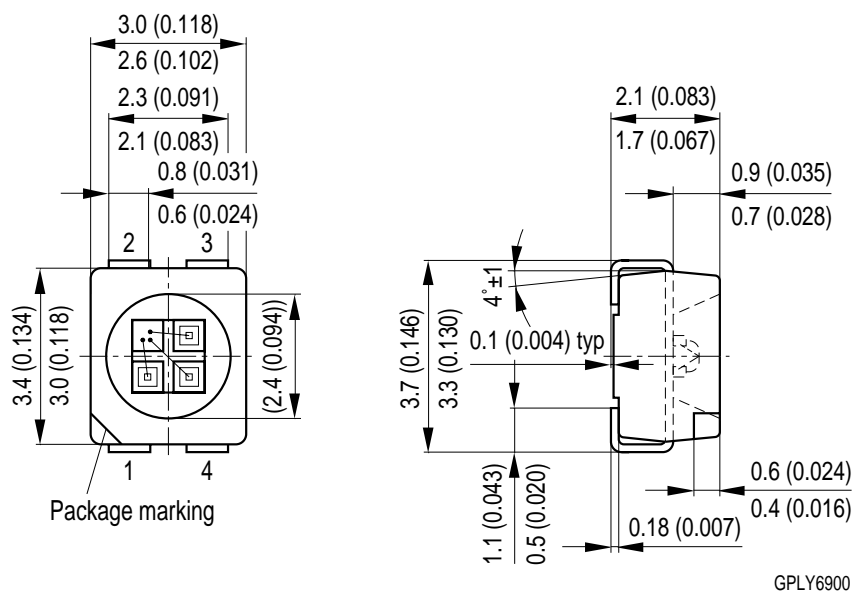

1	Cathode	Amber (A)
2	Anode	A, T, B
3	Cathode	Blue (B)
4	Cathode	True Green (T)

Maße werden wie folgt angegeben: mm (inch) / Dimensions are specified as follows: mm (inch).

**Gewicht / Approx. weight:** 34 mg

**Lötbedingungen** Vorbehandlung nach JEDEC Level 2  
**Soldering Conditions** Preconditioning acc. to JEDEC Level 2

**IR-Reflow Lötprofil** (nach IPC 9501)  
**IR Reflow Soldering Profile** (acc. to IPC 9501)

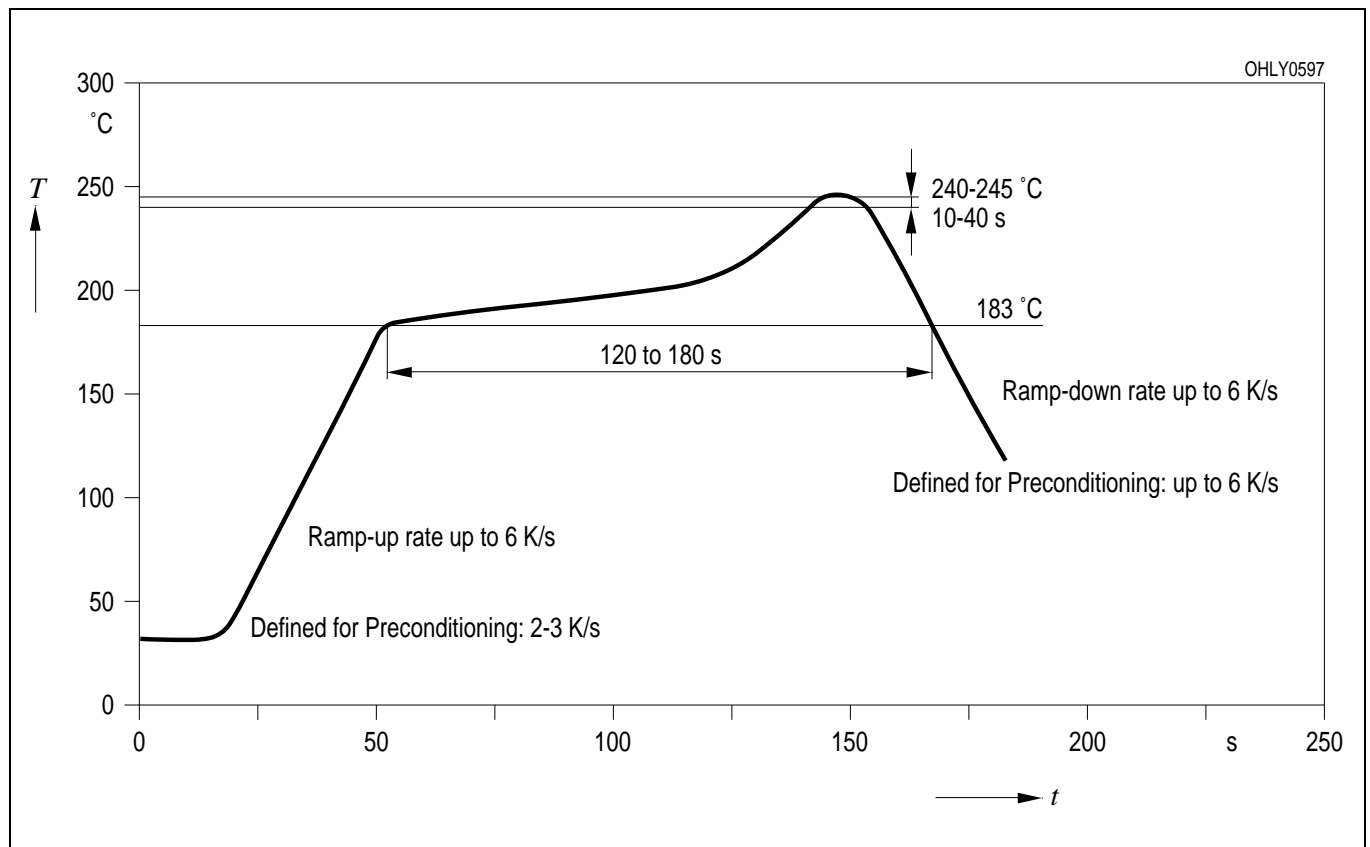

**Wellenlöten (TTW)** (nach CECC 00802)  
**TTW Soldering** (acc. to CECC 00802)

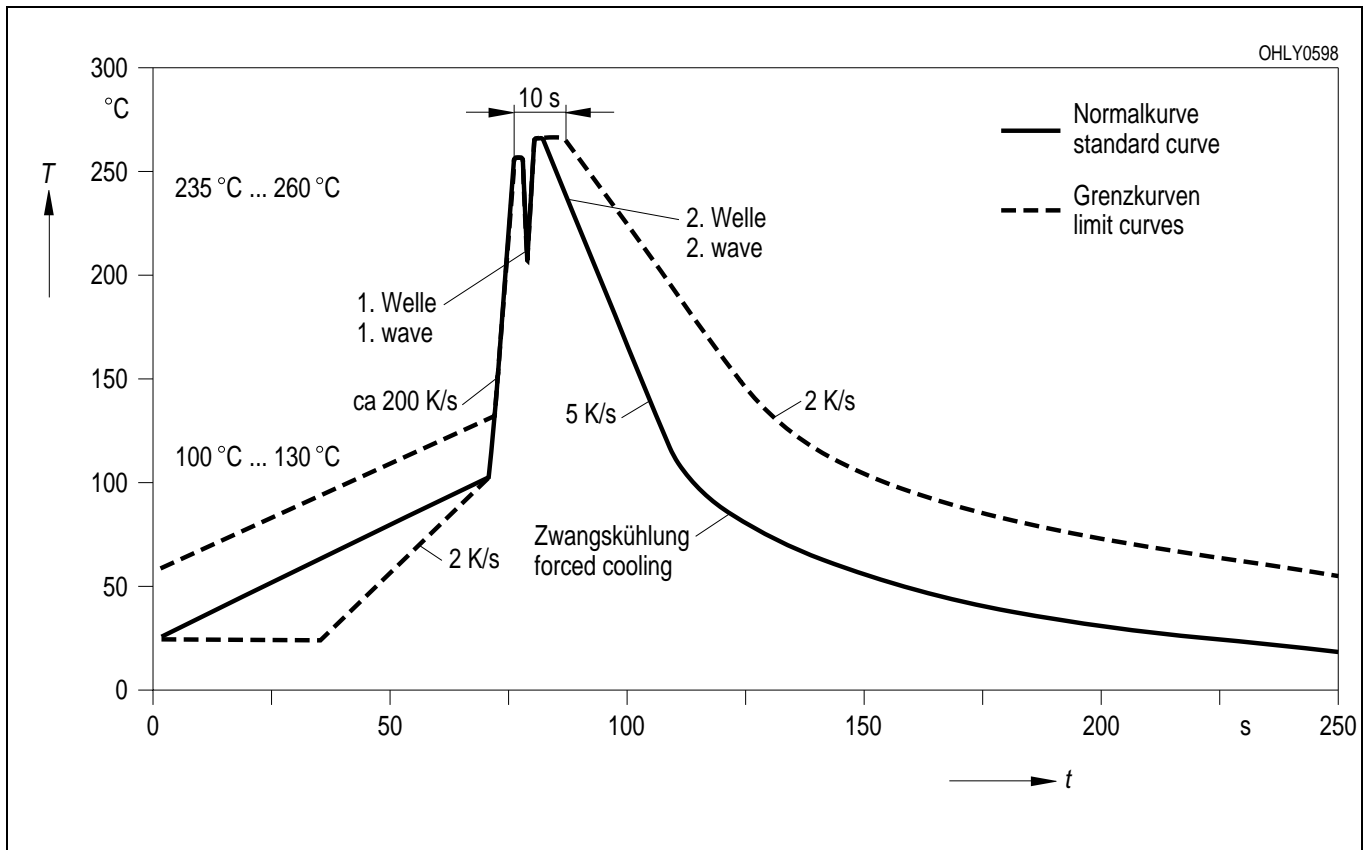

**Empfohlenes Lötpad Design** IR Reflow Lötten  
**Recommended Solder Pad** IR Reflow Soldering

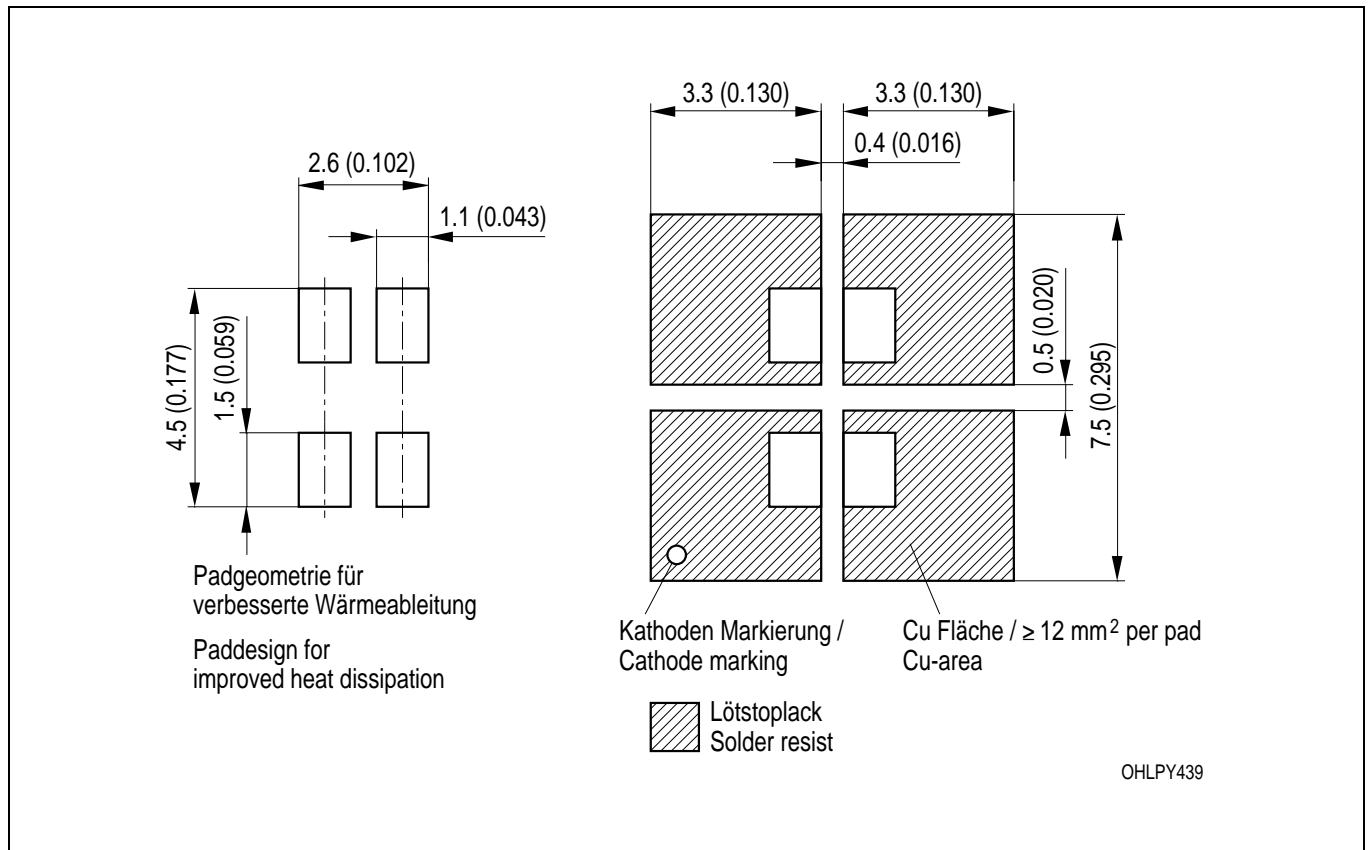

Maße werden wie folgt angegeben: mm (inch) / Dimensions are specified as follows: mm (inch).

**Empfohlenes Lötpad-Design** Wellenlöten (TTW)  
**Recommended Solder Pad** TTW Soldering

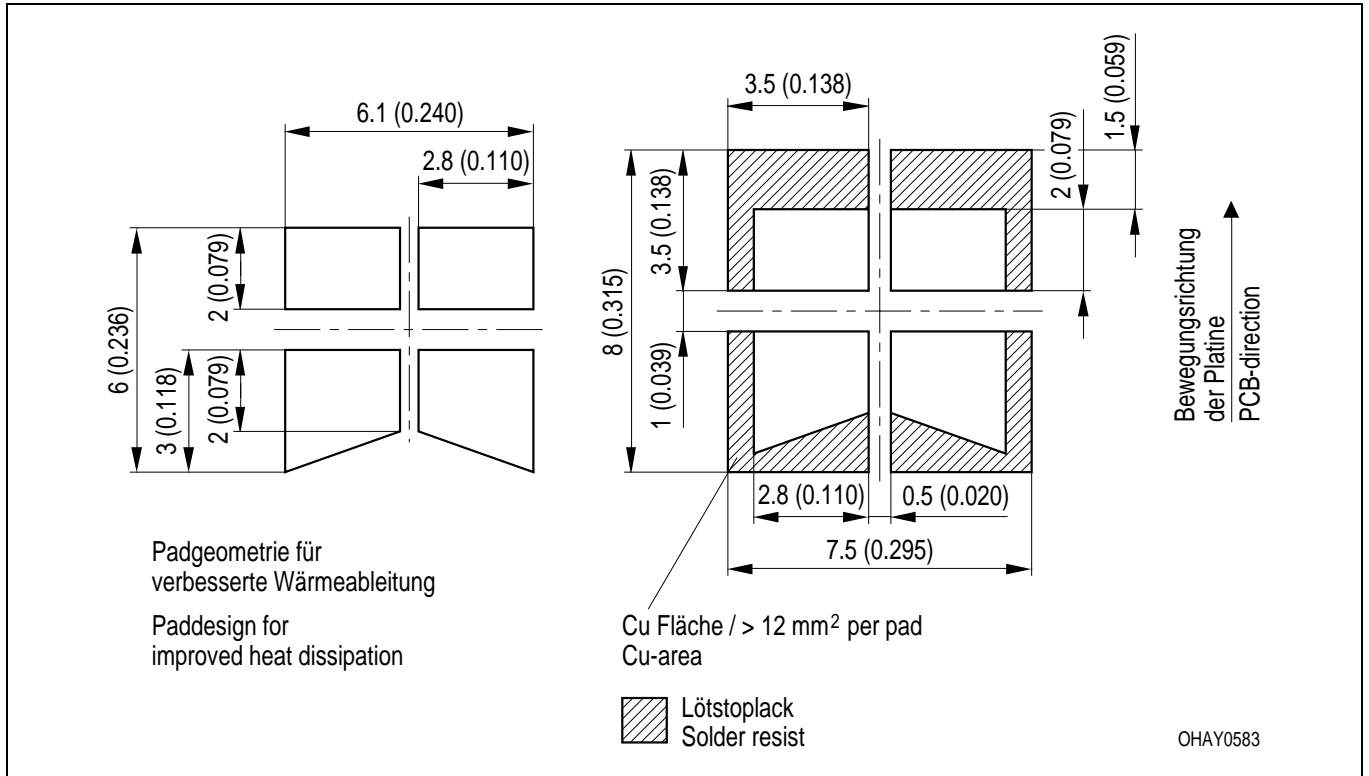

Maße werden wie folgt angegeben: mm (inch) / Dimensions are specified as follows: mm (inch).

**Gurtung / Polarität und Lage**

Verpackungseinheit 2000/Rolle, ø180 mm  
 oder 8000/Rolle, ø330 mm

**Method of Taping / Polarity and Orientation**

Packing unit 2000/reel, ø180 mm  
 or 8000/reel, ø330 mm

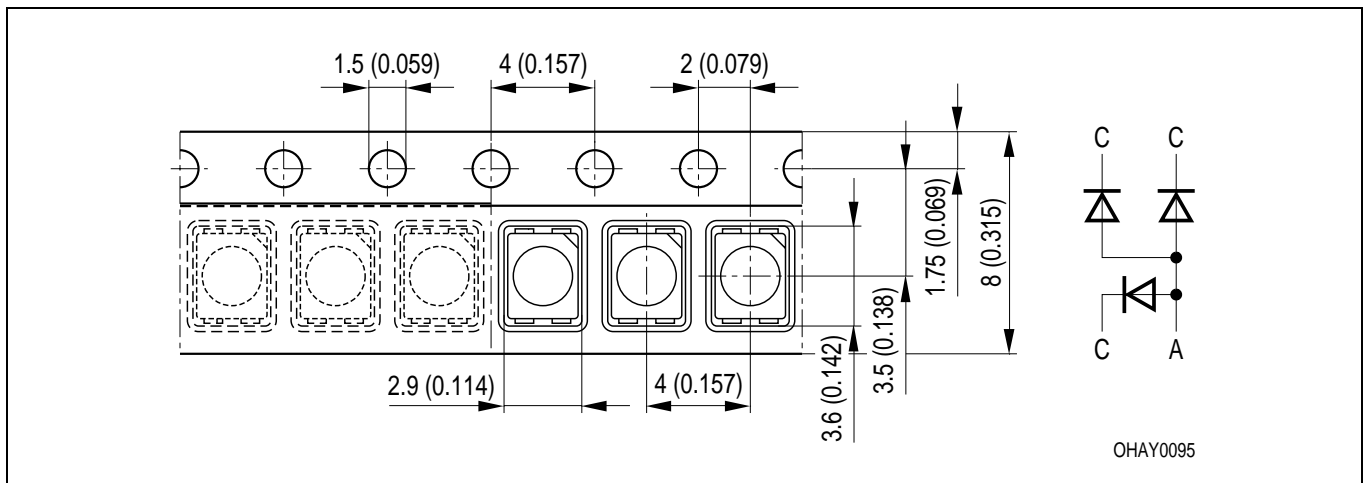

Maße werden wie folgt angegeben: mm (inch) / Dimensions are specified as follows: mm (inch).



---

**Revision History: 2001-06-22**

Previous Version: 2001-05-21

Page	Subjects (major changes since last revision)

**Published by OSRAM Opto Semiconductors GmbH & Co. OHG**  
**Wernerwerkstrasse 2, D-93049 Regensburg**

**© All Rights Reserved.**

**Attention please!**

The information describes the type of component and shall not be considered as assured characteristics. Terms of delivery and rights to change design reserved. Due to technical requirements components may contain dangerous substances. For information on the types in question please contact our Sales Organization.

**Packing**

Please use the recycling operators known to you. We can also help you – get in touch with your nearest sales office. By agreement we will take packing material back, if it is sorted. You must bear the costs of transport. For packing material that is returned to us unsorted or which we are not obliged to accept, we shall have to invoice you for any costs incurred.

**Components used in life-support devices or systems must be expressly authorized for such purpose!** Critical components <sup>1</sup> may only be used in life-support devices or systems <sup>2</sup> with the express written approval of OSRAM OS.

<sup>1</sup> A critical component is a component used in a life-support device or system whose failure can reasonably be expected to cause the failure of that life-support device or system, or to affect its safety or the effectiveness of that device or system.

<sup>2</sup> Life support devices or systems are intended (a) to be implanted in the human body, or (b) to support and/or maintain and sustain human life. If they fail, it is reasonable to assume that the health of the user may be endangered.