

### MEDIUM POWER THYRISTORS

### Stud Version

#### Features

- Improved glass passivation for high reliability and exceptional stability at high temperature
- High di/dt and dv/dt capabilities
- Standard package
- Low thermal resistance
- Metric threads version available
- Types up to 1200V  $V_{DRM}/V_{RRM}$

10A

#### Typical Applications

- Medium power switching
- Phase control applications
- Can be supplied to meet stringent military, aerospace and other high-reliability requirements

#### Major Ratings and Characteristics

Parameters	10RIA	Unit	
$I_{T(AV)}$	10	A	
@ $T_C$	85	°C	
$I_{T(RMS)}$	25	A	
$I_{TSM}$	@50Hz	225	A
	@60Hz	240	A
$I^2t$	@50Hz	255	A <sup>2</sup> s
	@60Hz	233	A <sup>2</sup> s
$V_{DRM}/V_{RRM}$	100 to 1200	V	
$t_q$ typical	110	μs	
$T_J$	- 65 to 125	°C	



**ELECTRICAL SPECIFICATIONS****Voltage Ratings**

Type number	Voltage Code	$V_{DRM}/V_{RRM}$ , max. repetitive peak and off-state voltage (1) V	$V_{RSM}$ , maximum non-repetitive peak voltage (2) V	$I_{DRM}/I_{RRM}$ max. @ $T_J = T_J$ max. mA
10RIA	10	100	150	20
	20	200	300	10
	40	400	500	
	60	600	700	
	80	800	900	
	100	1000	1100	
	120	1200	1300	

(1) Units may be broken over non-repetitively in the off-state direction without damage, if  $di/dt$  does not exceed 20A/ $\mu$ s

(2) For voltage pulses with  $t_p \leq 5$ ms

**On-state Conduction**

Parameter	10RIA	Units	Conditions
$I_{T(AV)}$ Max. average on-state current @ Case temperature	10	A	180° conduction, half sine wave
	85	°C	
$I_{T(RMS)}$ Max. RMS on-state current	25	A	
$I_{TSM}$ Max. peak, one-cycle non-repetitive surge current	225	A	t = 10ms No voltage
	240		t = 8.3ms reapplied
	190		t = 10ms 100% $V_{RRM}$
	200		t = 8.3ms reapplied
$I^2t$ Maximum $I^2t$ for fusing	255	$A^2s$	t = 10ms No voltage
	233		t = 8.3ms reapplied
	180		t = 10ms 100% $V_{RRM}$
	165		t = 8.3ms reapplied
$I^2\sqrt{t}$ Maximum $I^2\sqrt{t}$ for fusing	2550	$A^2\sqrt{s}$	t = 0.1 to 10ms, no voltage reapplied
$V_{T(TO)1}$ Low level value of threshold voltage	1.10	V	$(16.7\% \times \pi \times I_{T(AV)} < I < \pi \times I_{T(AV)})$ , $T_J = T_J$ max.
$V_{T(TO)2}$ High level value of threshold voltage	1.39		$(I > \pi \times I_{T(AV)})$ , $T_J = T_J$ max.
$r_{T1}$ Low level value of on-state slope resistance	24.3	m $\Omega$	$(16.7\% \times \pi \times I_{T(AV)} < I < \pi \times I_{T(AV)})$ , $T_J = T_J$ max.
$r_{T2}$ High level value of on-state slope resistance	16.7		$(I > \pi \times I_{T(AV)})$ , $T_J = T_J$ max.
$V_{TM}$ Max. on-state voltage	1.75	V	$I_{pk} = 32A$ , $T_J = 25^\circ C$ $t_p = 10$ ms sine pulse
$I_H$ Maximum holding current	130	mA	$T_J = 25^\circ C$ , anode supply 12V resistive load
$I_L$ Typical latching current	200		

### Switching

Parameter	10RIA	Units	Conditions
di/dt Max. rate of rise of turned-on current	$V_{DRM} \leq 600V$ 200 $V_{DRM} \leq 800V$ 180 $V_{DRM} \leq 1000V$ 160 $V_{DRM} \leq 1600V$ 150	A/ $\mu s$	$T_J = T_J \text{ max.}$ , $V_{DRM} = \text{rated } V_{DRM}$ Gate pulse = 20V, 15 $\Omega$ , $t_p = 6\mu s$ , $t_r = 0.1\mu s \text{ max.}$ $I_{TM} = (2x \text{ rated } di/dt) A$
$t_{gt}$ Typical turn-on time	0.9	$\mu s$	$T_J = 25^\circ C$ , at = rated $V_{DRM}/V_{RRM}$ , $T_J = 125^\circ C$
$t_{rr}$ Typical reverse recovery time	4		$T_J = T_J \text{ max.}$ , $I_{TM} = I_{T(AV)}$ , $t_p > 200\mu s$ , $di/dt = -10A/\mu s$
$t_q$ Typical turn-off time	110		$T_J = T_J \text{ max.}$ , $I_{TM} = I_{T(AV)}$ , $t_p > 200\mu s$ , $V_R = 100V$ , $di/dt = -10A/\mu s$ , $dv/dt = 20V/\mu s$ linear to 67% $V_{DRM}$ , gate bias 0V-100V

(\*)  $t_q = 10\mu s$  up to 600V,  $t_q = 30\mu s$  up to 1600V available on special request.

### Blocking

Parameter	10RIA	Units	Conditions
dv/dt Max. critical rate of rise of off-state voltage	100 300 (*)	V/ $\mu s$	$T_J = T_J \text{ max.}$ linear to 100% rated $V_{DRM}$ $T_J = T_J \text{ max.}$ linear to 67% rated $V_{DRM}$

(\*\*) Available with:  $dv/dt = 1000V/\mu s$ , to complete code add S90 i.e. 10RIA120S90.

### Triggering

Parameter	10RIA	Units	Conditions
$P_{GM}$ Maximum peak gate power	8.0	W	$T_J = T_J \text{ max.}$
$P_{G(AV)}$ Maximum average gate power	2.0		
$I_{GM}$ Max. peak positive gate current	1.5	A	$T_J = T_J \text{ max.}$
$-V_{GM}$ Maximum peak negative gate voltage	10	V	$T_J = T_J \text{ max.}$
$I_{GT}$ DC gate current required to trigger	90	mA	$T_J = -65^\circ C$
	60		$T_J = 25^\circ C$
	35		$T_J = 125^\circ C$
$V_{GT}$ DC gate voltage required to trigger	3.0	V	$T_J = -65^\circ C$
	2.0		$T_J = 25^\circ C$
	1.0		$T_J = 125^\circ C$
$I_{GD}$ DC gate current not to trigger	2.0	mA	$T_J = T_J \text{ max.}$ , $V_{DRM} = \text{rated value}$
$V_{GD}$ DC gate voltage not to trigger	0.2	V	$T_J = T_J \text{ max.}$ $V_{DRM} = \text{rated value}$ Max. gate current/ voltage not to trigger is the max. value which will not trigger any unit with rated $V_{DRM}$ anode-to-cathode applied

## 10RIA Series

Bulletin I2405 rev. A 07/00

International  
**IR** Rectifier

### Thermal and Mechanical Specification

Parameter	10RIA	Units	Conditions
T <sub>J</sub> Max. operating temperature range	- 65 to 125	°C	
T <sub>stg</sub> Max. storage temperature range	- 65 to 125	°C	
R <sub>thJC</sub> Max. thermal resistance, junction to case	1.85	K/W	DC operation
R <sub>thCS</sub> Max. thermal resistance, case to heatsink	0.35	K/W	Mounting surface, smooth, flat and greased
T Mounting torque	to nut	to device	
	20(27.5)	25	lbf-in
	0.23(0.32)	0.29	kgf.m
	2.3(3.1)	2.8	Nm
wt Approximate weight	14 (0.49)	g (oz)	
Case style	TO-208AA (TO-48)		See Outline Table

### $\Delta R_{thJC}$ Conduction

(The following table shows the increment of thermal resistance R<sub>thJC</sub> when devices operate at different conduction angles than DC)

Conduction angle	Sinusoidal conduction	Rectangular conduction	Units	Conditions
180°	0.44	0.32	K/W	T <sub>J</sub> = T <sub>J</sub> max.
120°	0.53	0.56		
90°	0.68	0.75		
60°	1.01	1.05		
30°	1.71	1.73		

### Ordering Information Table

Device Code
<div style="display: flex; justify-content: center; gap: 10px;"> <div style="border: 1px solid black; padding: 2px 5px; background-color: black; color: white;">10</div> <div style="border: 1px solid black; padding: 2px 5px; background-color: black; color: white;">RIA</div> <div style="border: 1px solid black; padding: 2px 5px; background-color: black; color: white;">120</div> <div style="border: 1px solid black; padding: 2px 5px; background-color: black; color: white;">M</div> <div style="border: 1px solid black; padding: 2px 5px; background-color: black; color: white;">S90</div> </div> <div style="display: flex; justify-content: center; gap: 10px; margin-top: 5px;"> <span>①</span> <span>②</span> <span>③</span> <span>④</span> <span>⑤</span> </div>
<p><b>1</b> - Current code</p> <p><b>2</b> - Essential part number</p> <p><b>3</b> - Voltage code: Code x 10 = V<sub>RRM</sub> (See Voltage Rating Table)</p> <p><b>4</b> - None = Stud base TO-208AA (TO-48) 1/4" 28UNF-2A M = Stud base TO-208AA (TO-48) M6 X 1</p> <p><b>5</b> - Critical dv/dt: None = 300V/μs (Standard value) S90 = 1000V/μs (Special selection)</p>

Outline Table

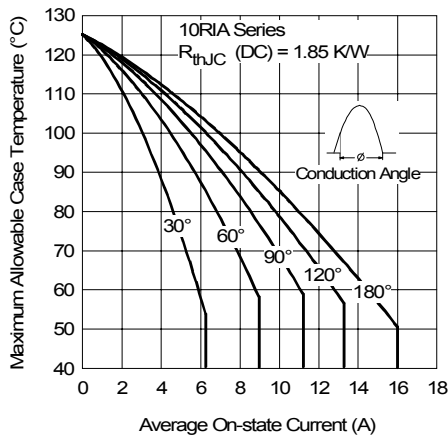
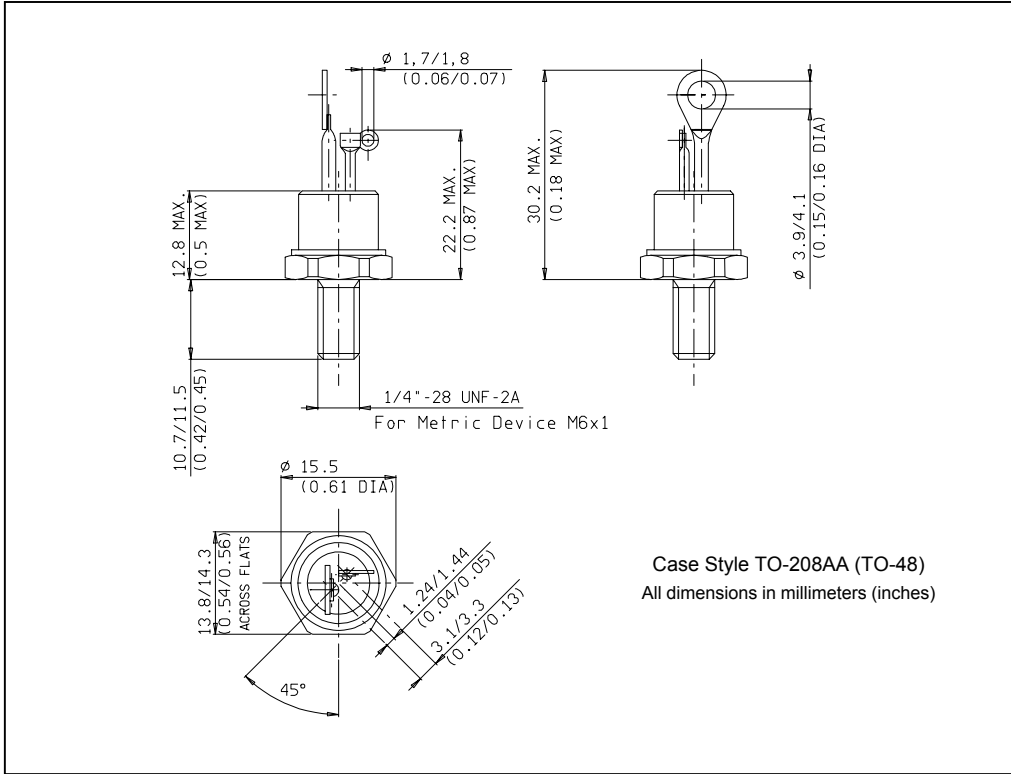

Fig. 1 - Current Ratings Characteristic

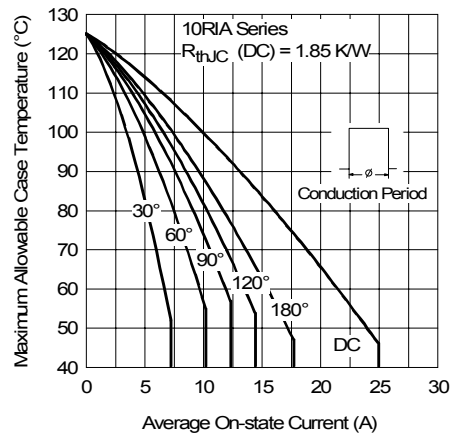

Fig. 2 - Current Ratings Characteristic

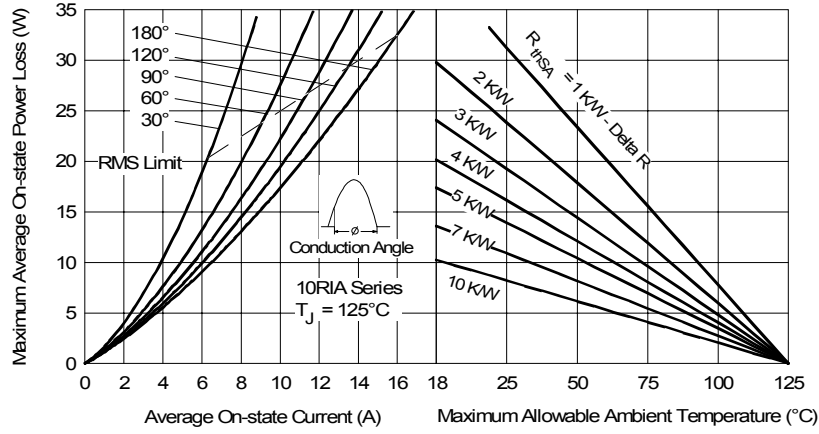

Fig. 3 - On-state Power Loss Characteristics

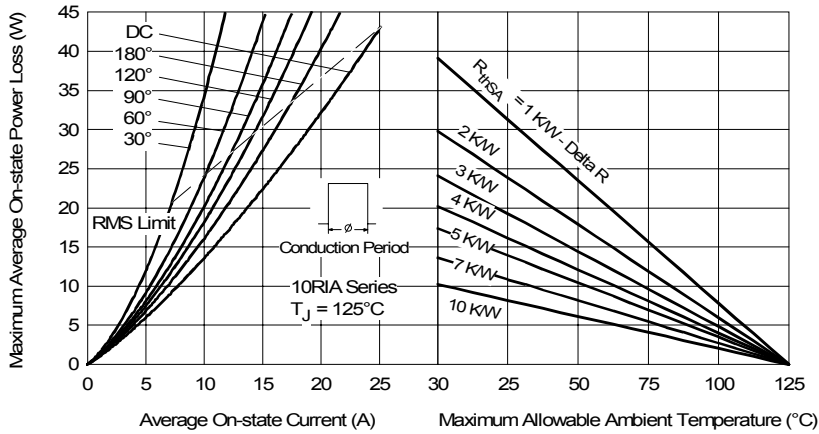

Fig. 4 - On-state Power Loss Characteristics

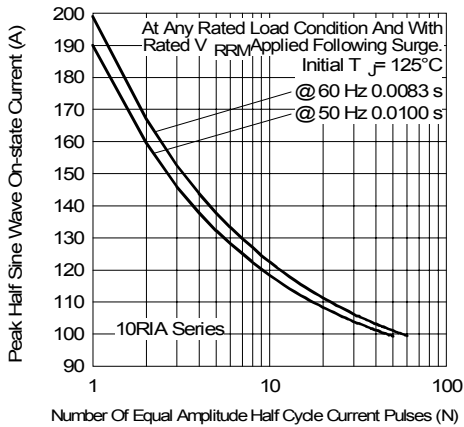

Fig. 5 - Maximum Non-Repetitive Surge Current

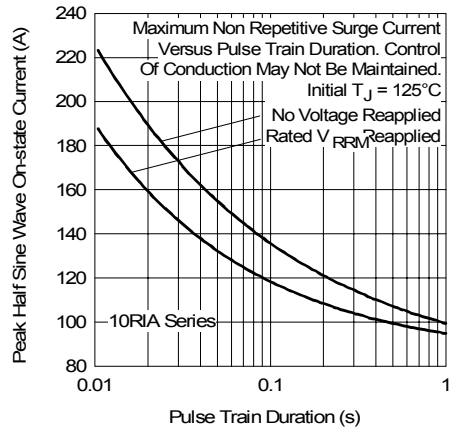

Fig. 6 - Maximum Non-Repetitive Surge Current

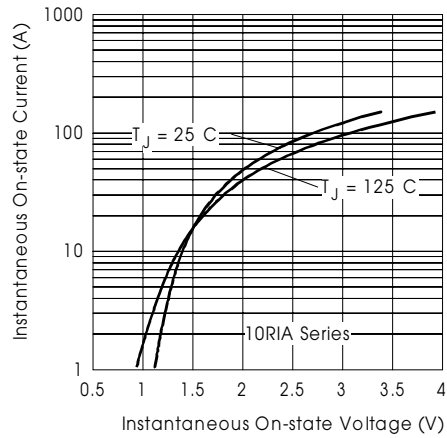

Fig. 7 - Forward Voltage Drop Characteristics

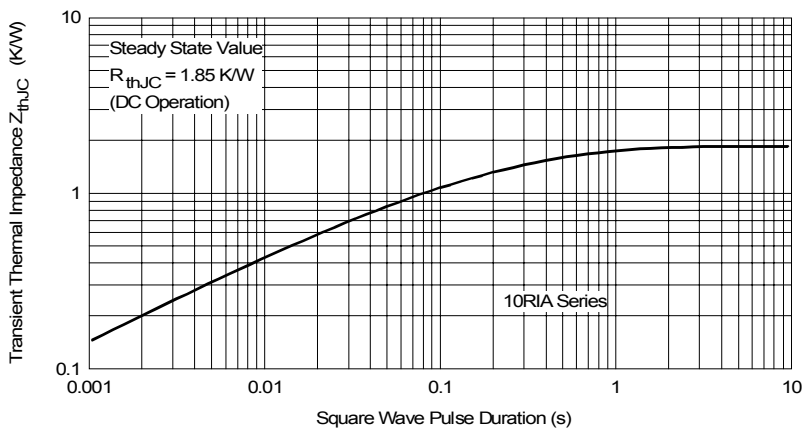

Fig. 8 - Thermal Impedance  $Z_{thJC}$  Characteristics

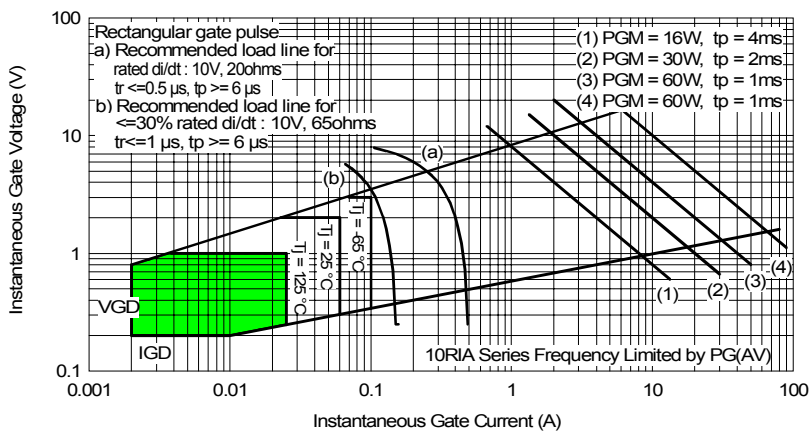

Fig. 9 - Gate Characteristics

**WORLD HEADQUARTERS:** 233 Kansas St., El Segundo, California 90245 U.S.A. Tel: (310) 322 3331. Fax: (310) 322 3332.  
**EUROPEAN HEADQUARTERS:** Hurst Green, Oxted, Surrey RH8 9BB, U.K. Tel: ++ 44 1883 732020. Fax: ++ 44 1883 733408.  
**IR CANADA:** 15 Lincoln Court, Brampton, Markham, Ontario L6T3Z2. Tel: (905) 453 2200. Fax: (905) 475 8801.  
**IR GERMANY:** Saalburgstrasse 157, 61350 Bad Homburg. Tel: ++ 49 6172 96590. Fax: ++ 49 6172 965933.  
**IR ITALY:** Via Liguria 49, 10071 Borgaro, Torino. Tel: ++ 39 11 4510111. Fax: ++ 39 11 4510220.  
**IR FAR EAST:** K&H Bldg., 2F, 30-4 Nishi-Ikebukuro 3-Chome, Toshima-Ku, Tokyo, Japan 171. Tel: 81 3 3983 0086.  
**IR SOUTHEAST ASIA:** 1 Kim Seng Promenade, Great World City West Tower, 13-11, Singapore 237994. Tel: ++ 65 838 4630.  
**IR TAIWAN:** 16 Fl. Suite D.207, Sec. 2, Tun Haw South Road, Taipei, 10673, Taiwan. Tel: 886 2 2377 9936.



This datasheet has been download from:

[www.datasheetcatalog.com](http://www.datasheetcatalog.com)

Datasheets for electronics components.