

InGaAs PIN photodiode G8421/G8371/G5851 series

Long wavelength type

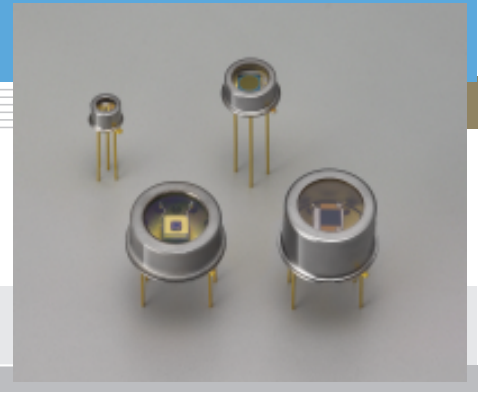

Features

- Long cut-off wavelength: 1.9 μm
- 3-pin TO-18 package: low price
- Thermoelectrically cooled TO-18 package: low dark current
- Active area: $\phi 0.3$ to $\phi 3$ mm

Applications

- Optical power meter
- Gas analyzer
- NIR (near infrared) photometry

Specifications / Absolute maximum ratings

Type No.	Dimensional outline/ Window material	Package	Cooling	Active area (mm)	Absolute maximum ratings				
					Thermistor power dissipation (mW)	TE-cooler allowable current (A)	Reverse voltage V_R (V)	Operating temperature T_{opr} ($^{\circ}\text{C}$)	Storage temperature T_{stg} ($^{\circ}\text{C}$)
G8421-03	①	TO-18	Non-cooled	$\phi 0.3$	-	-	2	-40 to +85	-55 to +125
G8421-05				$\phi 0.5$					
G8371-01				$\phi 1$					
G8371-03				$\phi 3$					
G5851-103	③	TO-8	One-stage TE-cooled	$\phi 0.3$	0.2	1.5	2	-40 to +70	-55 to +85
G5851-11				$\phi 1$					
G5851-13				$\phi 3$					
G5851-203	④	TO-8	Two-stage TE-cooled	$\phi 0.3$	0.2	1.0	2	-40 to +70	-55 to +85
G5851-21				$\phi 1$					
G5851-23				$\phi 3$					

Electrical and optical characteristics (Typ. unless otherwise noted)

Type No.	Measurement Condition	Spectral response range λ (μm)	Peak sensitivity wavelength λ_p (μm)	Photo sensitivity S $\lambda = \lambda_p$ (A/W)	Dark current I_D $V_R = 1$ V		Cut-off frequency f_c $V_R = 1$ V $R_L = 50 \Omega$ -3 dB (MHz)	Terminal capacitance C_t $V_R = 1$ V $f = 1$ MHz (pF)	Shunt resistance R_{sh} $V_R = 10$ mV (M Ω)	D^* $\lambda = \lambda_p$ ($\text{cm} \cdot \text{Hz}^{1/2}/\text{W}$)	NEP $\lambda = \lambda_p$ ($\text{W}/\text{Hz}^{1/2}$)
	Element temperature ($^{\circ}\text{C}$)				Typ. (nA)	Max. (nA)					
G8421-03	25	0.9 to 1.9	1.75	1.1	30	300	100	8	1.5	5×10^{11}	9×10^{-14}
G8421-05					50	500	80	20	1		1.5×10^{-13}
G8371-01					100	1000	40	80	0.5		2×10^{-13}
G8371-03					2000	20000	3	800	0.05		8×10^{-13}
G5851-103	-10	0.9 to 1.87	1.75	1.1	3	30	100	8	15	1.5×10^{12}	3×10^{-14}
G5851-11					10	100	40	80	5		6×10^{-14}
G5851-13					200	2000	3	800	0.5		2×10^{-13}
G5851-203	-20	0.9 to 1.85	1.75	1.1	1.5	15	100	8	35	2.5×10^{12}	2×10^{-14}
G5851-21					5	50	40	80	10		4×10^{-14}
G5851-23					100	1000	3	800	1		1.5×10^{-13}

■ Spectral response

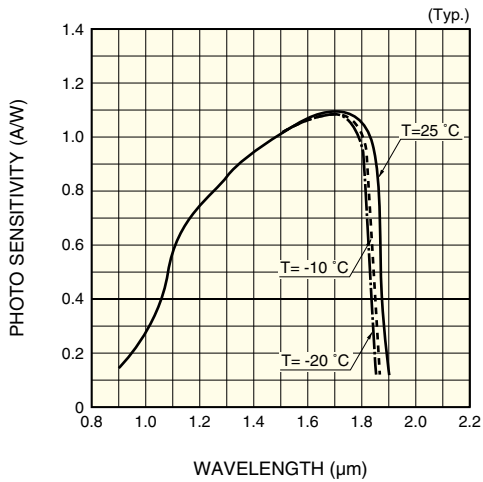

KIRDB0221EA

■ Photo sensitivity temperature characteristic

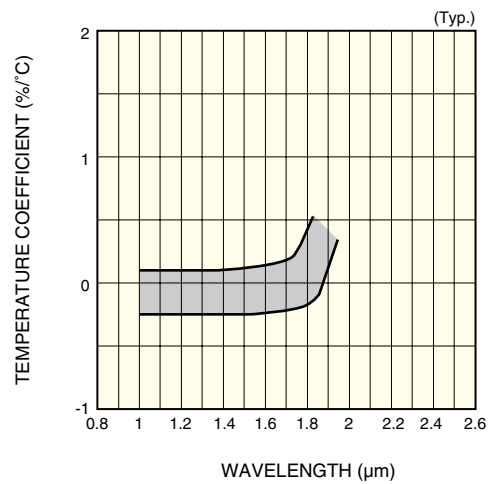

KIRDB0208EA

■ Dark current vs. reverse voltage

Non-cooled type

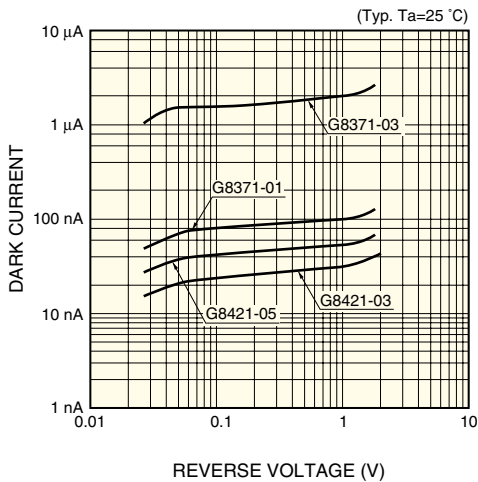

KIRDB0232EB

TE-cooled type

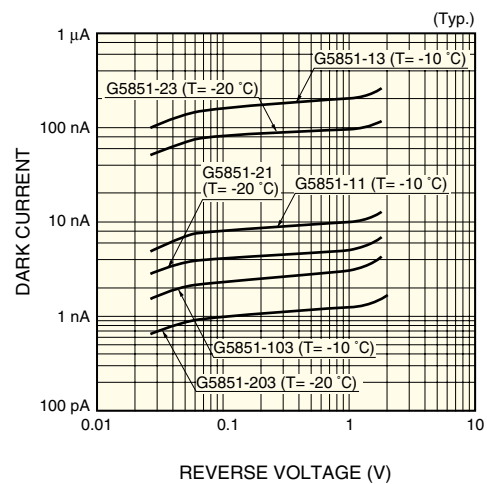

KIRDB0233EA

■ Terminal capacitance vs. reverse voltage

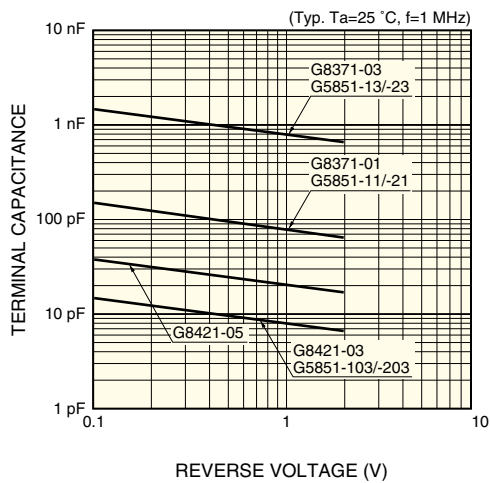

KIRDB0233EA

■ Shunt resistance vs. element temperature

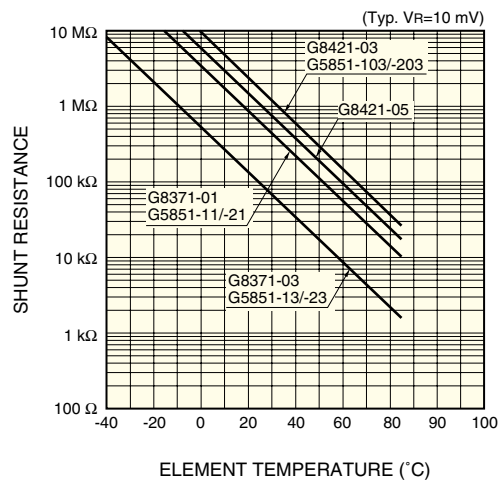

KIRDB0234EA

■ Thermistor temperature characteristic

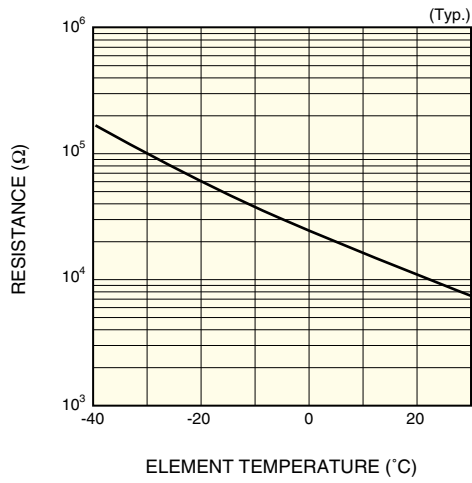

KIRDB0116EA

■ Cooling characteristics of TE-cooler

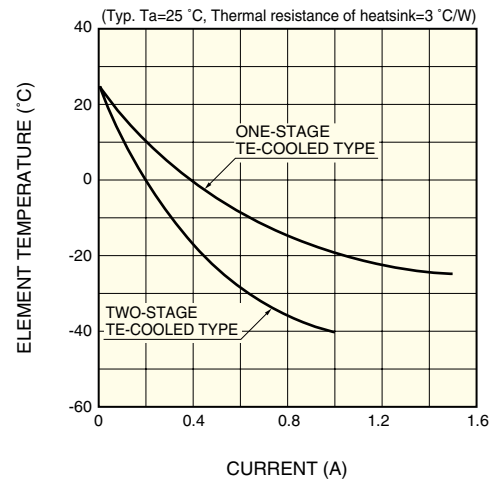

KIRDB0231EA

■ Current vs. voltage characteristics of TE-cooler

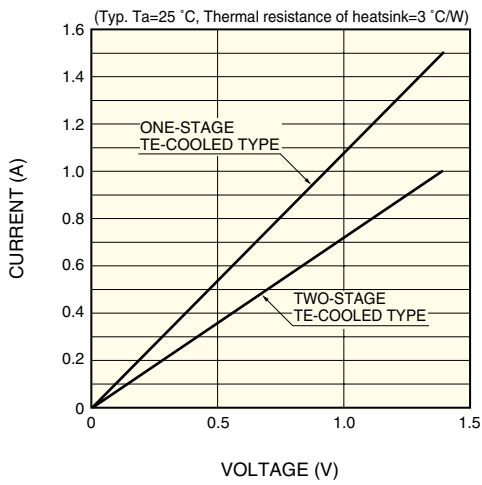

KIRDB0115EA

■ Dimensional outlines (unit: mm)

① G8421-03/-05, G8371-01

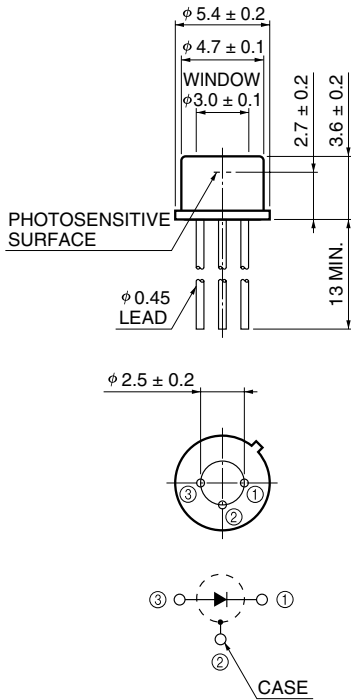

KIRDA0150EA

② G8371-03

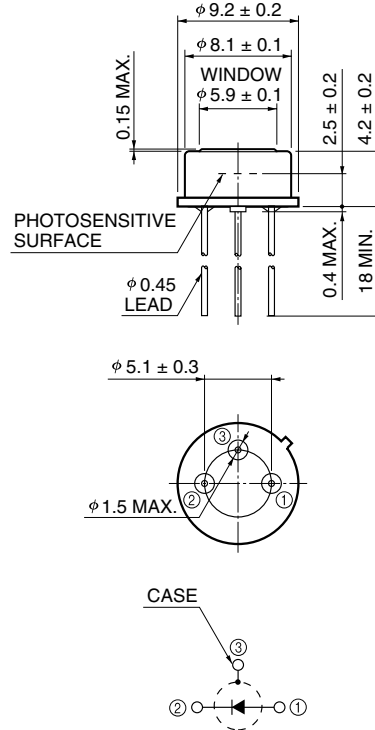

KIRDA0151EA

③ G5851-103/-11/-13

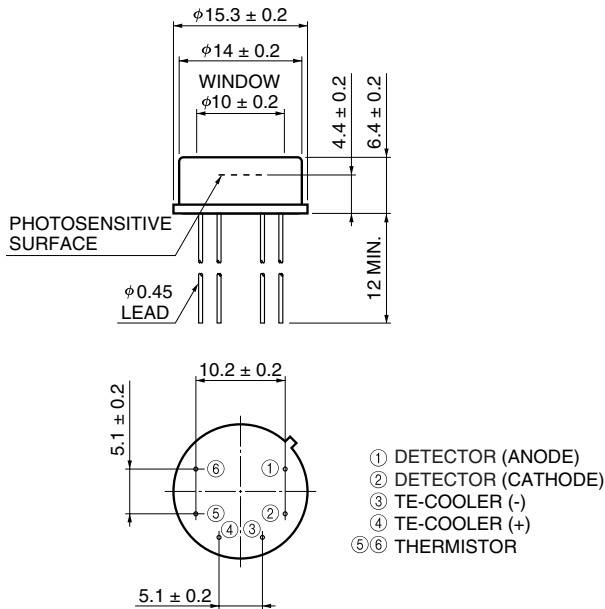

KIRDA0029EB

④ G5851-203/-21/-23

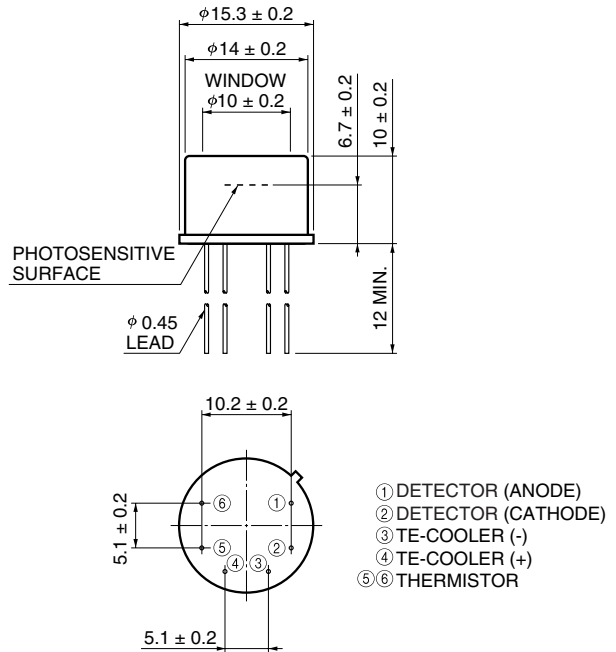

KIRDA0031EB

HAMAMATSU

Information furnished by HAMAMATSU is believed to be reliable. However, no responsibility is assumed for possible inaccuracies or omissions. Specifications are subject to change without notice. No patent rights are granted to any of the circuits described herein. ©2003 Hamamatsu Photonics K.K.

HAMAMATSU PHOTONICS K.K., Solid State Division

1126-1 Ichino-cho, Hamamatsu City, 435-8558 Japan, Telephone: (81) 053-434-3311, Fax: (81) 053-434-5184, <http://www.hamamatsu.com>

U.S.A.: Hamamatsu Corporation: 360 Foothill Road, P.O.Box 6910, Bridgewater, N.J. 08807-0910, U.S.A., Telephone: (1) 908-231-0960, Fax: (1) 908-231-1218

Germany: Hamamatsu Photonics Deutschland GmbH: Arzbergerstr. 10, D-82211 Herrsching am Ammersee, Germany, Telephone: (49) 08152-3750, Fax: (49) 08152-2658

France: Hamamatsu Photonics France S.A.R.L.: 8, Rue du Saule Trapu, Parc du Moulin de Massy, 91882 Massy Cedex, France, Telephone: 33-(1) 69 53 71 00, Fax: 33-(1) 69 53 71 10

United Kingdom: Hamamatsu Photonics UK Limited: 2 Howard Court, 10 Tewin Road, Welwyn Garden City, Hertfordshire AL7 1BW, United Kingdom, Telephone: (44) 1707-294888, Fax: (44) 1707-325777

North Europe: Hamamatsu Photonics Norden AB: Smidesvägen 12, SE-171 41 Solna, Sweden, Telephone: (46) 8-509-031-00, Fax: (46) 8-509-031-01

Italy: Hamamatsu Photonics Italia S.R.L.: Strada della Moia, 1/E, 20020 Arese, (Milano), Italy, Telephone: (39) 02-935-81-733, Fax: (39) 02-935-81-741