



## MIC5335

Dual, High Performance 300mA  $\mu$ Cap  
ULDO™

### General Description

The MIC5335 is a high current density, dual Ultra Low Dropout (ULDO™) linear regulator. The MIC5335 is ideally suited for portable electronics which demand overall high performance in a very small form factor. The MIC5335 is offered in the ultra small 1.6mm x 1.6mm 6-ld Thin MLF® package which is only 2.56mm<sup>2</sup> in area of the SOT-23, TSOP and the 3mm x 3mm MLF® package. The MIC5335 delivers exceptional thermal performances for those applications that demand higher power dissipation requirements in a very small foot print. In addition, the MIC5335 integrates two high performance 300mA LDOs with independent enable functions and offers high PSRR eliminating the need for a bypass capacitor.

The MIC5335 is a  $\mu$ Cap design which enables operation with very small output capacitors for stability, thereby reducing required board space and component cost.

The MIC5335 is available in fixed-output voltages. Additional voltages are available. For more information, contact Micrel's Marketing department.

Data sheets and support documentation can be found on Micrel's web site at: [www.micrel.com](http://www.micrel.com).

### Features

- 2.3V to 5.5V input voltage range
- Ultra-low dropout voltage: 75mV at 300mA
- Ultra Thin 1.6mm x 1.6mm 6 lead MLF® package
- Independent enable pins
- High PSRR - >65dB
- 300mA output current per LDO
- $\mu$ Cap Stable with 1 $\mu$ F ceramic capacitor
- Low quiescent current: 90 $\mu$ A/LDO
- Fast turn-on time: 30 $\mu$ s
- Thermal Shutdown Protection
- Current Limit Protection

### Applications

- Mobile Phones
- PDAs
- GPS Receivers

### Typical Application

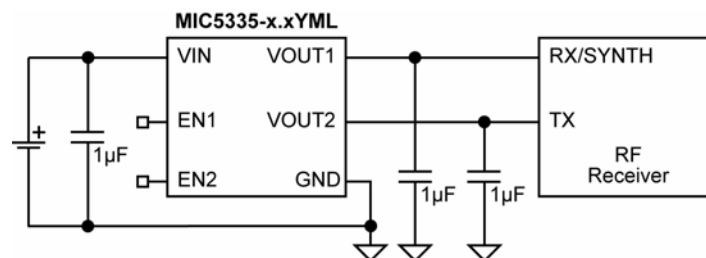

MicroLead Frame and MLF are registered trademarks of Amkor Technologies. ULDO is a trademark of Micrel, Inc.

Micrel Inc. • 2180 Fortune Drive • San Jose, CA 95131 • USA • tel +1 (408) 944-0800 • fax + 1 (408) 474-1000 • <http://www.micrel.com>

### MIC5335 Block Diagram

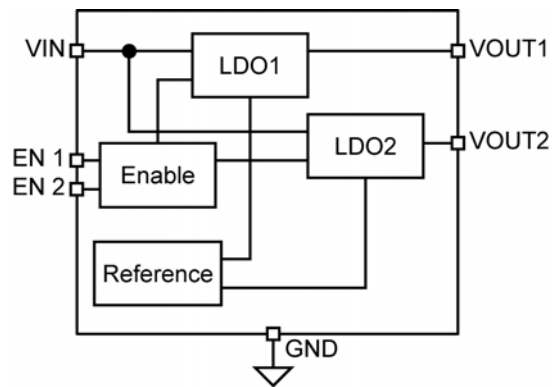

## Ordering Information

Part number	Manufacturing Part Number	Marking*	Voltage**	Junction Temp. Range	Package
MIC5335-1.8/1.5YMT	MIC5335-GFYMT	$\overline{\text{AGF}}$	1.8V/1.5V	-40°C to +125°C	6-Pin 1.6x1.6 Thin MLF <sup>®</sup>
MIC5335-1.8/1.6YMT	MIC5335-GWYMT	$\overline{\text{AGW}}$	1.8V/1.6V	-40°C to +125°C	6-Pin 1.6x1.6 Thin MLF <sup>®</sup>
MIC5335-2.5/1.8YMT	MIC5335-JGYMT	$\overline{\text{AJG}}$	2.5V/1.8V	-40°C to +125°C	6-Pin 1.6x1.6 Thin MLF <sup>®</sup>
MIC5335-2.5/2.5YMT	MIC5335-JJYMT	$\overline{\text{AJJ}}$	2.5V/2.5V	-40°C to +125°C	6-Pin 1.6x1.6 Thin MLF <sup>®</sup>
MIC5335-2.6/1.85YMT	MIC5335-KDYMT	$\overline{\text{AKD}}$	2.6V/1.85V	-40°C to +125°C	6-Pin 1.6x1.6 Thin MLF <sup>®</sup>
MIC5335-2.6/1.8YMT	MIC5335-KGYMT	$\overline{\text{AKG}}$	2.6V/1.8V	-40°C to +125°C	6-Pin 1.6x1.6 Thin MLF <sup>®</sup>
MIC5335-2.7/2.7YMT	MIC5335-LLYMT	$\overline{\text{ALL}}$	2.7V/2.7V	-40°C to +125°C	6-Pin 1.6x1.6 Thin MLF <sup>®</sup>
MIC5335-2.8/1.5YMT	MIC5335-MFYMT	$\overline{\text{AMF}}$	2.8V/1.5V	-40°C to +125°C	6-Pin 1.6x1.6 Thin MLF <sup>®</sup>
MIC5335-2.8/1.8YMT	MIC5335-MGYMT	$\overline{\text{AMG}}$	2.8V/1.8V	-40°C to +125°C	6-Pin 1.6x1.6 Thin MLF <sup>®</sup>
MIC5335-2.8/2.6YMT	MIC5335-MKYMT	$\overline{\text{AMK}}$	2.8V/2.6V	-40°C to +125°C	6-Pin 1.6x1.6 Thin MLF <sup>®</sup>
MIC5335-2.8/2.8YMT	MIC5335-MMYMT	$\overline{\text{AMM}}$	2.8V/2.8V	-40°C to +125°C	6-Pin 1.6x1.6 Thin MLF <sup>®</sup>
MIC5335-2.8/2.85YMT	MIC5335-MNYMT	$\overline{\text{AMN}}$	2.8V/2.85V	-40°C to +125°C	6-Pin 1.6x1.6 Thin MLF <sup>®</sup>
MIC5335-2.85/1.85YMT	MIC5335-NDYMT	$\overline{\text{AND}}$	2.85V/1.85V	-40°C to +125°C	6-Pin 1.6x1.6 Thin MLF <sup>®</sup>
MIC5335-2.85/2.6YMT	MIC5335-NKYMT	$\overline{\text{ANK}}$	2.85V/2.6V	-40°C to +125°C	6-Pin 1.6x1.6 Thin MLF <sup>®</sup>
MIC5335-2.85/2.85YMT	MIC5335-NNYMT	$\overline{\text{ANN}}$	2.85V/2.85V	-40°C to +125°C	6-Pin 1.6x1.6 Thin MLF <sup>®</sup>
MIC5335-2.9/1.5YMT	MIC5335-OFYMT	$\overline{\text{AOF}}$	2.9V/1.5V	-40°C to +125°C	6-Pin 1.6x1.6 Thin MLF <sup>®</sup>
MIC5335-2.9/1.8YMT	MIC5335-OGYMT	$\overline{\text{AOG}}$	2.9V/1.8V	-40°C to +125°C	6-Pin 1.6x1.6 Thin MLF <sup>®</sup>
MIC5335-2.9/2.9YMT	MIC5335-OOYMT	$\overline{\text{AOO}}$	2.9V/2.9V	-40°C to +125°C	6-Pin 1.6x1.6 Thin MLF <sup>®</sup>
MIC5335-3.0/1.8YMT	MIC5335-PGYMT	$\overline{\text{APG}}$	3.0V/1.8V	-40°C to +125°C	6-Pin 1.6x1.6 Thin MLF <sup>®</sup>
MIC5335-3.0/2.5YMT	MIC5335-PJYMT	$\overline{\text{APJ}}$	3.0V/2.5V	-40°C to +125°C	6-Pin 1.6x1.6 Thin MLF <sup>®</sup>
MIC5335-3.0/2.6YMT	MIC5335-PKYMT	$\overline{\text{APK}}$	3.0V/2.6V	-40°C to +125°C	6-Pin 1.6x1.6 Thin MLF <sup>®</sup>
MIC5335-3.0/2.8YMT	MIC5335-PMYMT	$\overline{\text{APM}}$	3.0V/2.8V	-40°C to +125°C	6-Pin 1.6x1.6 Thin MLF <sup>®</sup>
MIC5335-3.0/2.85YMT	MIC5335-PNYMT	$\overline{\text{APN}}$	3.0V/2.85V	-40°C to +125°C	6-Pin 1.6x1.6 Thin MLF <sup>®</sup>
MIC5335-3.0/3.0YMT	MIC5335-PPYMT	$\overline{\text{APP}}$	3.0V/3.0V	-40°C to +125°C	6-Pin 1.6x1.6 Thin MLF <sup>®</sup>
MIC5335-3.3/1.5YMT	MIC5335-SFYMT	$\overline{\text{ASF}}$	3.3V/1.5V	-40°C to +125°C	6-Pin 1.6x1.6 Thin MLF <sup>®</sup>
MIC5335-3.3/1.8YMT	MIC5335-SGYMT	$\overline{\text{ASG}}$	3.3V/1.8V	-40°C to +125°C	6-Pin 1.6x1.6 Thin MLF <sup>®</sup>
MIC5335-3.3/2.5YMT	MIC5335-SJYMT	$\overline{\text{ASJ}}$	3.3V/2.5V	-40°C to +125°C	6-Pin 1.6x1.6 Thin MLF <sup>®</sup>
MIC5335-3.3/2.6YMT	MIC5335-SKYMT	$\overline{\text{ASK}}$	3.3V/2.6V	-40°C to +125°C	6-Pin 1.6x1.6 Thin MLF <sup>®</sup>
MIC5335-3.3/2.7YMT	MIC5335-SLYMT	$\overline{\text{ASL}}$	3.3V/2.7V	-40°C to +125°C	6-Pin 1.6x1.6 Thin MLF <sup>®</sup>
MIC5335-3.3/2.8YMT	MIC5335-SMYMT	$\overline{\text{ASM}}$	3.3V/2.8V	-40°C to +125°C	6-Pin 1.6x1.6 Thin MLF <sup>®</sup>
MIC5335-3.3/2.85YMT	MIC5335-SNYMT	$\overline{\text{ASN}}$	3.3V/2.85V	-40°C to +125°C	6-Pin 1.6x1.6 Thin MLF <sup>®</sup>
MIC5335-3.3/2.9YMT	MIC5335-SOYMT	$\overline{\text{ASO}}$	3.3V/2.9V	-40°C to +125°C	6-Pin 1.6x1.6 Thin MLF <sup>®</sup>
MIC5335-3.3/3.0YMT	MIC5335-SPYMT	$\overline{\text{ASP}}$	3.3V/3.0V	-40°C to +125°C	6-Pin 1.6x1.6 Thin MLF <sup>®</sup>
MIC5335-3.3/3.2YMT	MIC5335-SRYMT	$\overline{\text{ASR}}$	3.3V/3.2V	-40°C to +125°C	6-Pin 1.6x1.6 Thin MLF <sup>®</sup>
MIC5335-3.3/3.3YMT	MIC5335-SSYMT	$\overline{\text{ASS}}$	3.3V/3.3V	-40°C to +125°C	6-Pin 1.6x1.6 Thin MLF <sup>®</sup>

**Note:**

- \* Under bar/Over bar symbol may not be to scale.
- \*\* For other voltages available. Contact Micrel Marketing for details.

## Pin Configuration

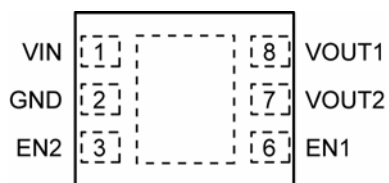

6-pin 1.6mm x 1.6mm Thin MLF<sup>®</sup>  
Top View

## Pin Description

Pin Number Thin MLF-6	Pin Name	Pin Function
1	VIN	Supply Input.
2	GND	Ground
3	EN2	Enable Input (regulator 2). Active High Input. Logic High = On; Logic Low = Off; Do not leave floating.
4	EN1	Enable Input (regulator 1). Active High Input. Logic High = On; Logic Low = Off; Do not leave floating.
5	VOUT2	Regulator Output – LDO2
6	VOUT1	Regulator Output – LDO1

**Absolute Maximum Ratings<sup>(1)</sup>**

Supply Voltage ( $V_{IN}$ ).....	0V to +6V
Enable Input Voltage ( $V_{EN}$ ).....	0V to +6V
Power Dissipation.....	Internally Limited <sup>(3)</sup>
Lead Temperature (soldering, 3sec.....)	260°C
Storage Temperature ( $T_S$ ).....	-65°C to +150°C
ESD Rating <sup>(4)</sup> .....	2kV

**Operating Ratings<sup>(2)</sup>**

Supply voltage ( $V_{IN}$ ).....	+2.3V to +5.5V
Enable Input Voltage ( $V_{EN}$ ).....	0V to $V_{IN}$
Junction Temperature .....	-40°C to +125°C
Junction Thermal Resistance	
Thin MLF <sup>®</sup> -6 ( $\theta_{JA}$ ) .....	100°C/W

**Electrical Characteristics<sup>(5)</sup>**

$V_{IN} = EN1 = EN2 = V_{OUT} + 1.0V$ ; higher of the two regulator outputs,  $I_{OUTLDO1} = I_{OUTLDO2} = 100\mu A$ ;  $C_{OUT1} = C_{OUT2} = 1\mu F$ ;  $T_J = 25^\circ C$ , **bold** values indicate  $-40^\circ C \leq T_J \leq +125^\circ C$ , unless noted.

Parameter	Conditions	Min	Typ	Max	Units
Output Voltage Accuracy	Variation from nominal $V_{OUT}$	-2.0		+2.0	%
	Variation from nominal $V_{OUT}$ ; $-40^\circ C$ to $+125^\circ C$	<b>-3.0</b>		<b>+3.0</b>	%
Line Regulation	$V_{IN} = V_{OUT} + 1V$ to 5.5V; $I_{OUT} = 100\mu A$		0.02	0.3 <b>0.6</b>	%/V %/V
Load Regulation	$I_{OUT} = 100\mu A$ to 300mA		0.3	<b>2.0</b>	%
Dropout Voltage ( <b>Note 6</b> )	$I_{OUT} = 100\mu A$		0.1		mV
	$I_{OUT} = 100mA$		25	<b>75</b>	mV
	$I_{OUT} = 150mA$		35	<b>100</b>	mV
	$I_{OUT} = 300mA$		75	<b>200</b>	mV
Ground Current	EN1 = High; EN2 = Low; $I_{OUT} = 100\mu A$ to 300mA		90	<b>120</b>	$\mu A$
	EN1 = Low; EN2 = High; $I_{OUT} = 100\mu A$ to 300mA		90	<b>120</b>	$\mu A$
	EN1 = EN2 = High; $I_{OUT1} = 300mA$ , $I_{OUT2} = 300mA$		150	<b>190</b>	$\mu A$
Ground Current in Shutdown	EN1 = EN2 = 0V		0.01	2	$\mu A$
Ripple Rejection	$f = 1kHz$ ; $C_{OUT} = 1.0\mu F$		65		dB
Current Limit	$V_{OUT} = 0V$	<b>350</b>	550	<b>950</b>	mA
Output Voltage Noise	$C_{OUT} = 1.0\mu F$ ; 10Hz to 10MHz		90		$\mu V_{RMS}$
<b>Enable Inputs (EN1 / EN2)</b>					
Enable Input Voltage	Logic Low			<b>0.2</b>	V
	Logic High	<b>1.1</b>			V
Enable Input Current	$V_{IL} \leq 0.2V$		0.01	1	$\mu A$
	$V_{IH} \geq 1.0V$		0.01	1	$\mu A$
<b>Turn-on Time (See Timing Diagram)</b>					
Turn-on Time (LDO1 and 2)	$C_{OUT} = 1.0\mu F$		30	<b>100</b>	$\mu s$

**Notes:**

- Exceeding the absolute maximum rating may damage the device.
- The device is not guaranteed to function outside its operating rating.
- The maximum allowable power dissipation of any  $T_A$  (ambient temperature) is  $P_{D(max)} = (T_{J(max)} - T_A) / \theta_{JA}$ . Exceeding the maximum allowable power dissipation will result in excessive die temperature, and the regulator will go into thermal shutdown.
- Devices are ESD sensitive. Handling precautions recommended. Human body model, 1.5k in series with 100pF.
- Specification for packaged product only.
- Dropout voltage is defined as the input-to-output differential at which the output voltage drops 2% below its nominal  $V_{OUT}$ . For outputs below 2.3V, the dropout voltage is the input-to-output differential with the minimum input voltage 2.3V.

# Typical Characteristics

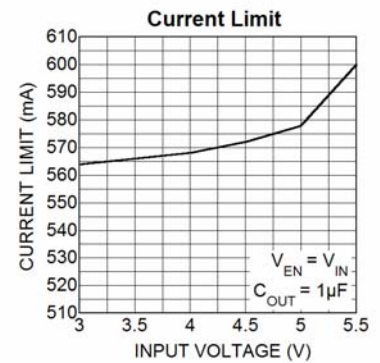
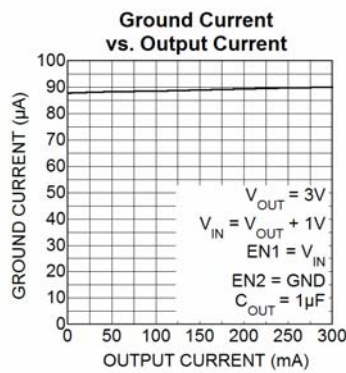
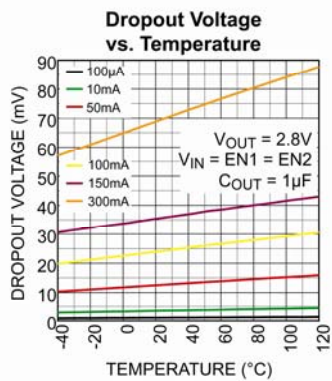
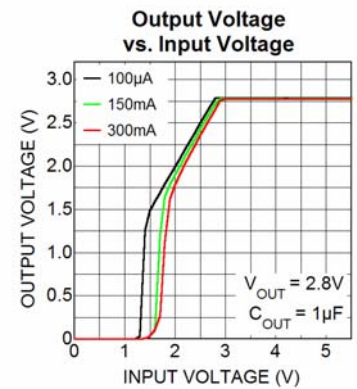
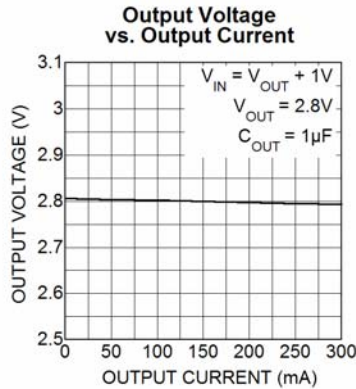
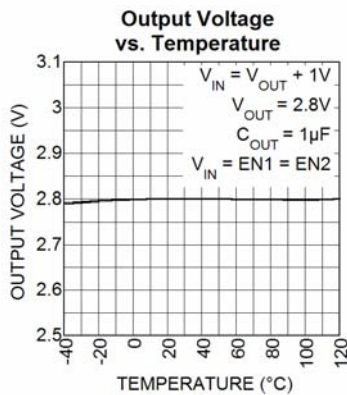
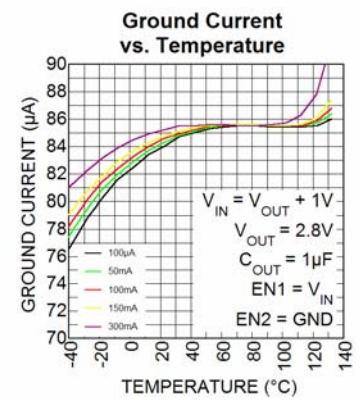
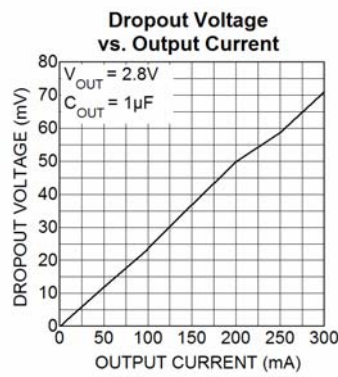
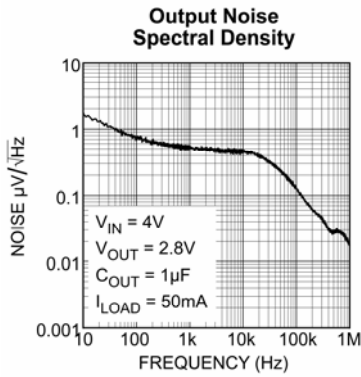

### Functional Characteristics

Line Transient

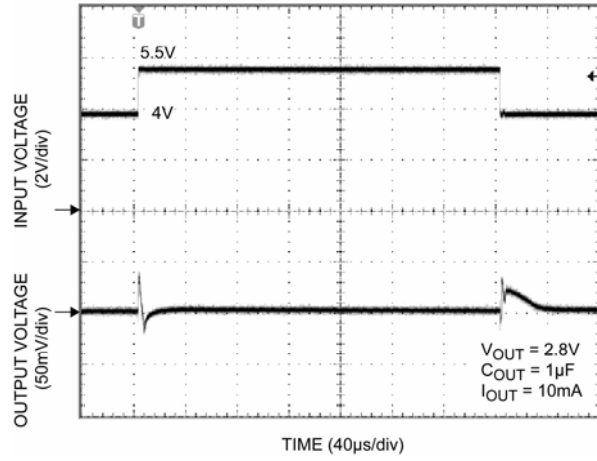

Load Transient

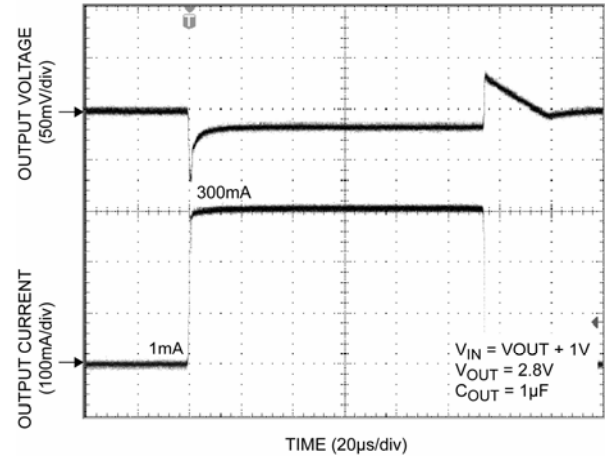

Enable Turn-On

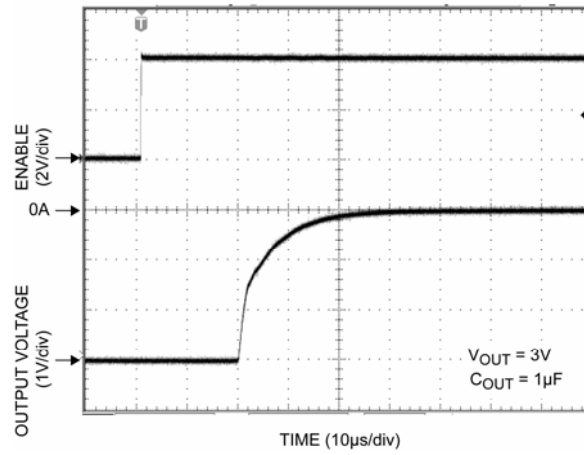

## Applications Information

### Enable/Shutdown

The MIC5335 comes with dual active-high enable pins that allow each regulator to be disabled independently. Forcing the enable pin low disables the regulator and sends it into a “zero” off-mode-current state. In this state, current consumed by the regulator goes nearly to zero. Forcing the enable pin high enables the output voltage. The active-high enable pin uses CMOS technology and the enable pin cannot be left floating; a floating enable pin may cause an indeterminate state on the output.

### Input Capacitor

The MIC5335 is a high-performance, high bandwidth device. Therefore, it requires a well-bypassed input supply for optimal performance. A 1 $\mu$ F capacitor is required from the input-to-ground to provide stability. Low-ESR ceramic capacitors provide optimal performance at a minimum of space. Additional high-frequency capacitors, such as small-valued NPO dielectric-type capacitors, help filter out high-frequency noise and are good practice in any RF-based circuit.

### Output Capacitor

The MIC5335 requires an output capacitor of 1 $\mu$ F or greater to maintain stability. The design is optimized for use with low-ESR ceramic chip capacitors. High ESR capacitors may cause high frequency oscillation. The output capacitor can be increased, but performance has been optimized for a 1 $\mu$ F ceramic output capacitor and does not improve significantly with larger capacitance.

X7R/X5R dielectric-type ceramic capacitors are recommended because of their temperature performance. X7R-type capacitors change capacitance by 15% over their operating temperature range and are the most stable type of ceramic capacitors on the market. Z5U and Y5V dielectric capacitors change value by as much as 50% and 60%, respectively, over their operating temperature ranges. To use a ceramic chip capacitor with Y5V dielectric, the value must be much higher than an X7R ceramic capacitor to ensure the same minimum capacitance over the equivalent operating temperature range.

### No-Load Stability

Unlike many other voltage regulators, the MIC5335 will remain stable and in regulation with no load. This is especially important in CMOS RAM keep-alive applications.

## Thermal Considerations

The MIC5335 is designed to provide 300mA of continuous current for both outputs in a very small package. Maximum ambient operating temperature can be calculated based upon the output current and the voltage drop across the part. Given that the input voltage is 3.3V, the output voltage is 2.8V for  $V_{OUT1}$ , 2.5V for  $V_{OUT2}$  and the output current = 300mA. The actual power dissipation of the regulator circuit can be determined using the equation:

$$P_D = (V_{IN} - V_{OUT1}) I_{OUT1} + (V_{IN} - V_{OUT2}) I_{OUT2} + V_{IN} I_{GND}$$

Because this device is CMOS and the ground current is typically <100 $\mu$ A over the load range, the power dissipation contributed by the ground current is < 1% and can be ignored for this calculation.

$$P_D = (3.3V - 2.8V) \times 300mA + (3.3V - 2.5V) \times 300mA$$

$$P_D = 0.39W$$

To determine the maximum ambient operating temperature of the package, use the junction-to-ambient thermal resistance of the device and the following basic equation:

$$P_{D(max)} = \left( \frac{T_{J(max)} - T_A}{\theta_{JA}} \right)$$

$T_{J(max)} = 125^\circ\text{C}$ , the maximum junction temperature of the die  $\theta_{JA}$  thermal resistance = 100 $^\circ\text{C/W}$ .

The table that follows shows junction-to-ambient thermal resistance for the MIC5335 in the Thin MLF<sup>®</sup> package.

Package	$\theta_{JA}$ Recommended Minimum Footprint	$\theta_{JC}$
6-Pin 1.6 X1.6 Thin MLF <sup>™</sup>	100 $^\circ\text{C/W}$	2 $^\circ\text{C/W}$

### Thermal Resistance

Substituting  $P_D$  for  $P_{D(max)}$  and solving for the ambient operating temperature will give the maximum operating conditions for the regulator circuit. The junction-to-ambient thermal resistance for the minimum footprint is 100 $^\circ\text{C/W}$ .

The maximum power dissipation must not be exceeded for proper operation.

For example, when operating the MIC5335-MFYML at an input voltage of 3.3V and 300mA loads at each



output with a minimum footprint layout, the maximum ambient operating temperature  $T_A$  can be determined as follows:

$$0.39W = (125^{\circ}C - T_A)/(100^{\circ}C/W)$$

$$T_A = 86^{\circ}C$$

Therefore, a 2.8V/2.5V application with 300mA at each output current can accept an ambient operating

temperature of 86°C in a 1.6mm x 1.6mm Thin MLF<sup>®</sup> package. For a full discussion of heat sinking and thermal effects on voltage regulators, refer to the "Regulator Thermals" subsection of *Micrel's Designing with Low-Dropout Voltage Regulators* handbook. This information can be found on Micrel's website at:

[http://www.micrel.com/\\_PDF/other/LDOBk\\_ds.pdf](http://www.micrel.com/_PDF/other/LDOBk_ds.pdf)

**Package Information**

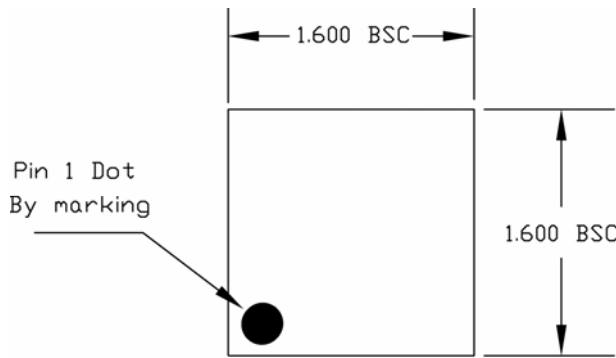

TOP VIEW

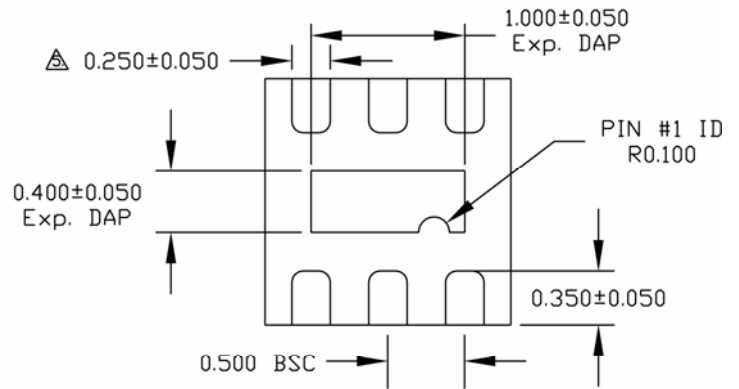

BOTTOM VIEW

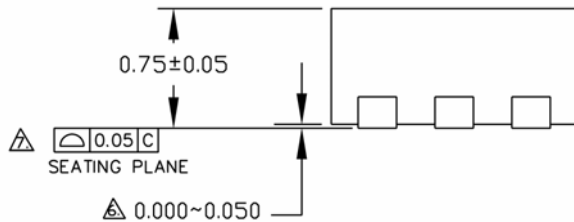

SIDE VIEW

NOTE:

1. ALL DIMENSIONS ARE IN MILLIMETERS.
  2. MAX. PACKAGE WARPAGE IS 0.05 mm.
  3. MAXIMUM ALLOWABLE BURRS IS 0.076 mm IN ALL DIRECTIONS.
  4. PIN #1 ID ON TOP WILL BE LASER/INK MARKED.
- $\Delta$  DIMENSION APPLIES TO METALIZED TERMINAL AND IS MEASURED BETWEEN 0.20 AND 0.25 mm FROM TERMINAL TIP.
- $\Delta$  APPLIED ONLY FOR TERMINALS.
- $\Delta$  APPLIED FOR EXPOSED PAD AND TERMINALS.

**6-Pin 1.6mm x 1.6mm Thin MLF<sup>®</sup> (MT)**

**MICREL, INC. 2180 FORTUNE DRIVE SAN JOSE, CA 95131 USA**  
 TEL +1 (408) 944-0800 FAX +1 (408) 474-1000 WEB <http://www.micrel.com>

The information furnished by Micrel in this data sheet is believed to be accurate and reliable. However, no responsibility is assumed by Micrel for its use. Micrel reserves the right to change circuitry and specifications at any time without notification to the customer.

Micrel Products are not designed or authorized for use as components in life support appliances, devices or systems where malfunction of a product can reasonably be expected to result in personal injury. Life support devices or systems are devices or systems that (a) are intended for surgical implant into the body or (b) support or sustain life, and whose failure to perform can be reasonably expected to result in a significant injury to the user. A Purchaser's use or sale of Micrel Products for use in life support appliances, devices or systems is a Purchaser's own risk and Purchaser agrees to fully indemnify Micrel for any damages resulting from such use or sale.

© 2006 Micrel, Inc.