



STD35NF3LL

N-channel 30V - 0.014 Ω - 35A - DPAK
STripFET™ II Power MOSFET

General features

Type	V _{DSS}	R _{DS(on)}	I _D
STD35NF3LL	30V	<0.0195 Ω	35A

- Optimal R_{DS(on)} x Q_g trade-off @ 4.5V
- Conduction losses reduced
- Switching losses reduced
- Low threshold drive

Description

This application specific Power MOSFET is the third generation of STMicroelectronics unique "single feature size™" strip-based process. The resulting transistor shows the best trade-off between on-resistance and gate charge. When used as high and low side in buck regulators, it gives the best performance in terms of both conduction and switching losses. This is extremely important for motherboards where fast switching and high efficiency are of paramount importance. remarkable manufacturing reproducibility.

Applications

- Switching application

Order codes

Part number	Marking	Package	Packaging
STD35NF3LLT4	D35NF3LL	DPAK	Tape & reel

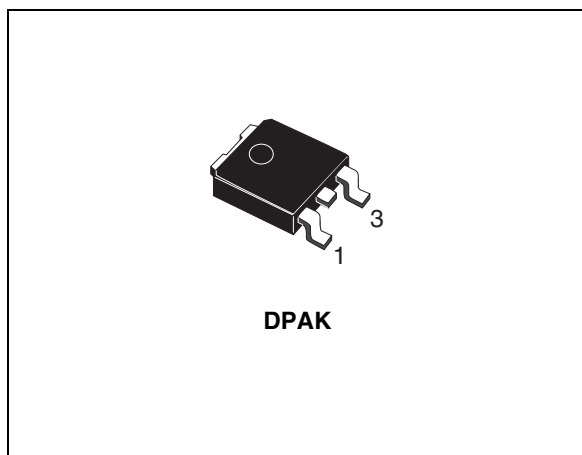

Internal schematic diagram

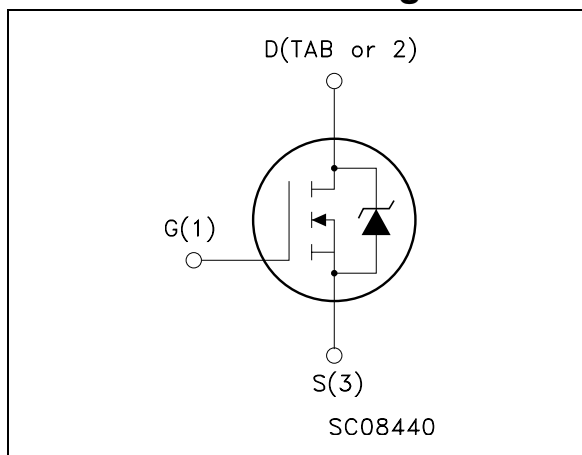

Contents

1	Electrical ratings	3
2	Electrical characteristics	4
	2.1 Electrical characteristics (curves)	6
3	Test circuit	8
4	Package mechanical data	9
5	Packing mechanical data	12
6	Revision history	13

1 Electrical ratings

Table 1. Absolute maximum ratings

Symbol	Parameter	Value	Unit
V_{DS}	Drain-source voltage ($V_{GS} = 0$)	30	V
V_{GS}	Gate- source voltage	± 16	V
I_D	Drain current (continuous) at $T_C = 25^\circ\text{C}$	35	A
I_D	Drain current (continuous) at $T_C = 100^\circ\text{C}$	25	A
$I_{DM}^{(1)}$	Drain current (pulsed)	140	A
P_{tot}	Total dissipation at $T_C = 25^\circ\text{C}$	50	W
	Derating factor	0.33	W/°C
$E_{AS}^{(2)}$	Single pulse avalanche energy	300	mJ
T_{stg}	Storage temperature	-55 to 175	°C
T_j	Max. operating junction temperature		

1. Pulse width limited by safe operating area.

2. Starting $T_j = 25^\circ\text{C}$, $I_D = 17.5\text{A}$, $V_{DD} = 24\text{V}$

Table 2. Thermal data

$R_{thj-case}$	Thermal resistance junction-case max	3	°C/W
$R_{thj-amb}$	Thermal resistance junction-to ambient max	100	°C/W
T_J	Maximum lead temperature for soldering purpose	300	°C

2 Electrical characteristics

($T_{CASE}=25^{\circ}\text{C}$ unless otherwise specified)

Table 3. On/off states

Symbol	Parameter	Test conditions	Min.	Typ.	Max.	Unit
$V_{(BR)DSS}$	Drain-source breakdown voltage	$I_D = 250\mu\text{A}$, $V_{GS} = 0$	30			V
I_{DSS}	Zero gate voltage drain current ($V_{GS} = 0$)	$V_{DS} = \text{Max rating}$ $V_{DS} = \text{Max rating @ } 125^{\circ}\text{C}$			1 10	μA μA
I_{GSS}	Gate-body leakage current ($V_{DS} = 0$)	$V_{GS} = \pm 16\text{V}$			± 100	nA
$V_{GS(th)}$	Gate threshold voltage	$V_{DS} = V_{GS}$, $I_D = 250\mu\text{A}$	1		2.5	V
$R_{DS(on)}$	Static drain-source on resistance	$V_{GS} = 10\text{V}$, $I_D = 17.5\text{A}$ $V_{GS} = 4.5\text{V}$, $I_D = 17.5\text{A}$		0.014 0.016	0.0195 0.0215	Ω Ω

Table 4. Dynamic

Symbol	Parameter	Test conditions	Min.	Typ.	Max.	Unit
$g_{fs}^{(1)}$	Forward transconductance	$V_{DS} = 15\text{V}$, $I_D = 17.5\text{A}$		19		S
C_{iss} C_{oss} C_{rss}	Input capacitance Output capacitance Reverse transfer capacitance	$V_{DS} = 25\text{V}$, $f = 1\text{MHz}$, $V_{GS} = 0$		800 250 60		pF pF pF
$t_{d(on)}$ t_r $t_{d(off)}$ t_f	Turn-on delay time Rise time Turn-off delay time Fall time	$V_{DD} = 15\text{V}$, $I_D = 17.5\text{A}$ $R_G = 4.7\Omega$, $V_{GS} = 4.5\text{V}$ (see Figure 12)		17 100 20 21		ns ns ns ns
Q_g Q_{gs} Q_{gd}	Total gate charge Gate-source charge Gate-drain charge	$V_{DD} = 24\text{V}$, $I_D = 35\text{A}$, $V_{GS} = 5\text{V}$, $R_G = 4.7\Omega$ (see Figure 13)		12.5 42 5.2	17	nC nC nC

1. Pulsed: Pulse duration = 300 μs , duty cycle 1.5%.

Table 5. Source drain diode

Symbol	Parameter	Test conditions	Min.	Typ.	Max.	Unit
I_{SD} $I_{SDM}^{(1)}$	Source-drain current Source-drain current (pulsed)				35 140	A A
$V_{SD}^{(2)}$	Forward on voltage	$I_{SD} = 35A, V_{GS} = 0$			1.3	V
t_{rr} Q_{rr} I_{RRM}	Reverse recovery time Reverse recovery charge Reverse recovery current	$I_{SD} = 35A, di/dt = 100A/\mu s,$ $V_{DD} = 15V, T_j = 150^\circ C$ (see Figure 17)		35 44 2.5		ns nC A

1. Pulse width limited by safe operating area.
2. Pulsed: Pulse duration = 300 μs , duty cycle 1.5%

2.1 Electrical characteristics (curves)

Figure 1. Safe operating area

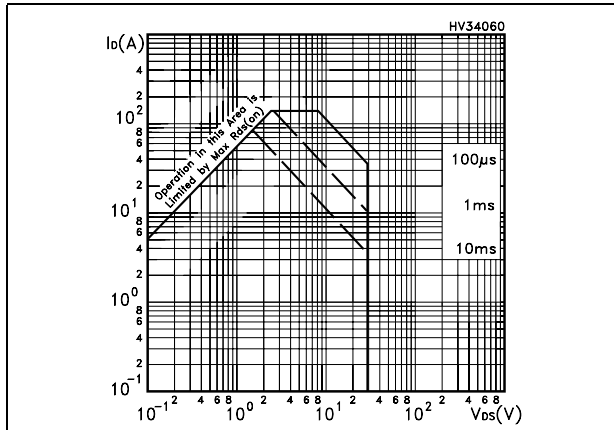

Figure 2. Thermal impedance

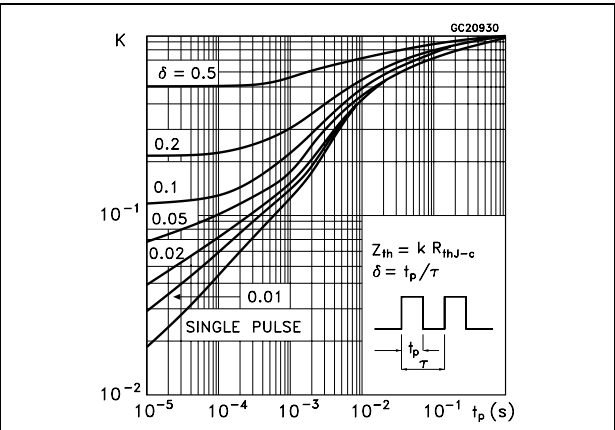

Figure 3. Output characteristics

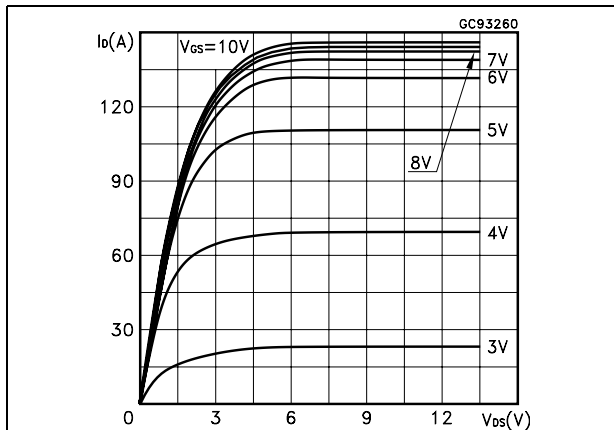

Figure 4. Transfer characteristics

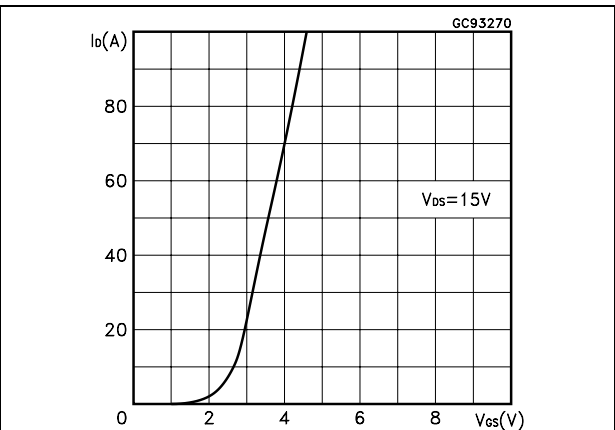

Figure 5. Transconductance

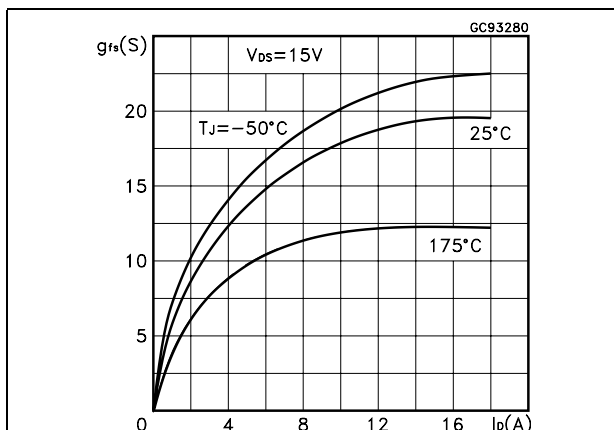

Figure 6. Static drain-source on resistance

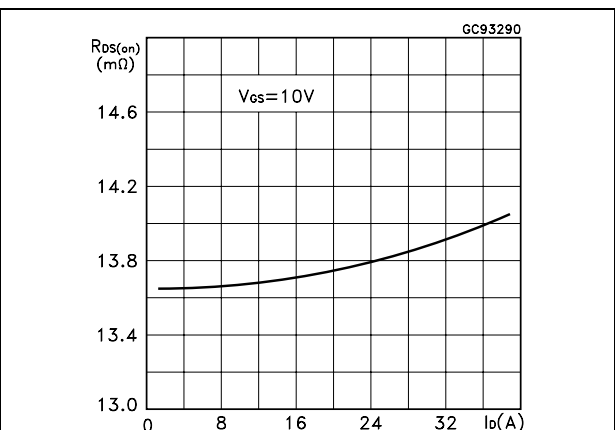

Figure 7. Gate charge vs. gate-source voltage Figure 8. Capacitance variations

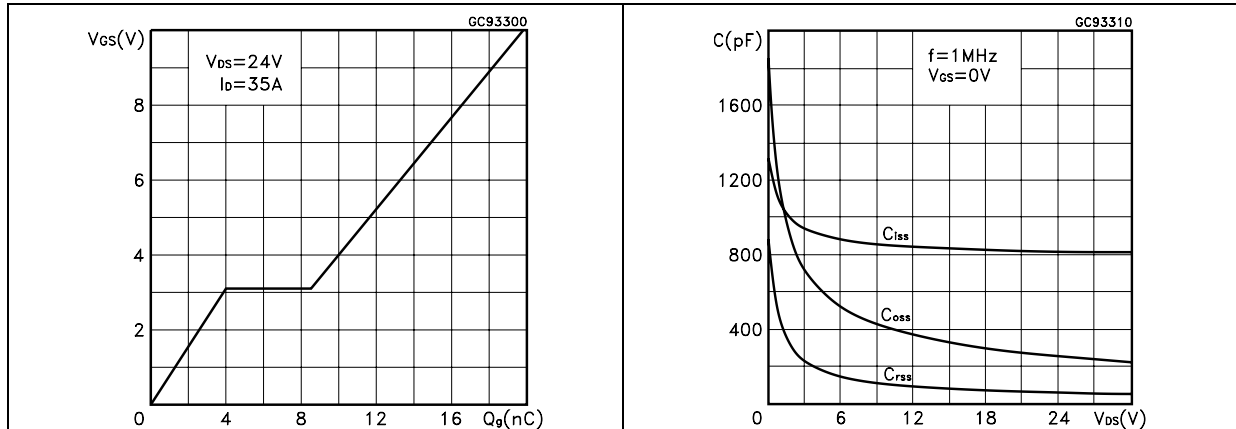

Figure 9. Normalized gate threshold voltage vs. temperature Figure 10. Normalized on resistance vs. temperature

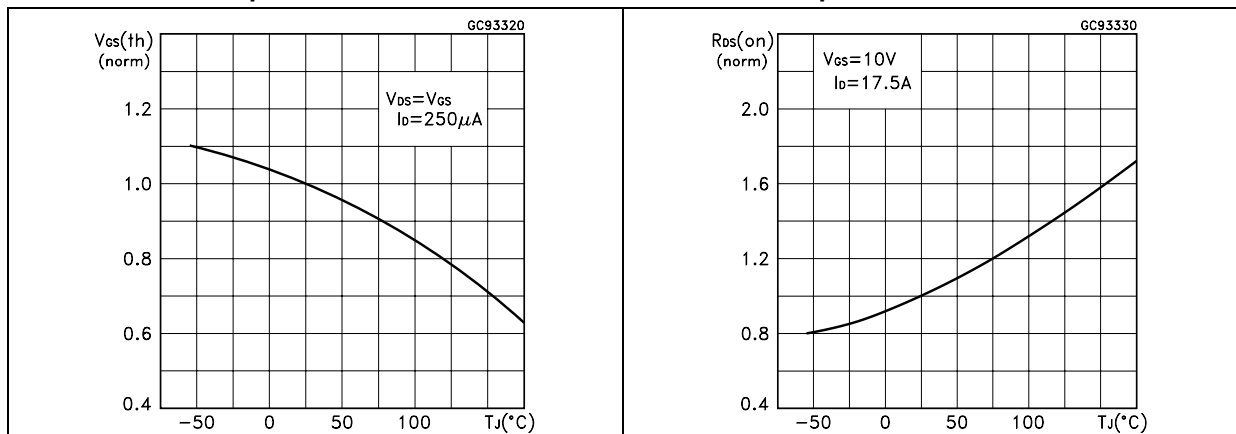
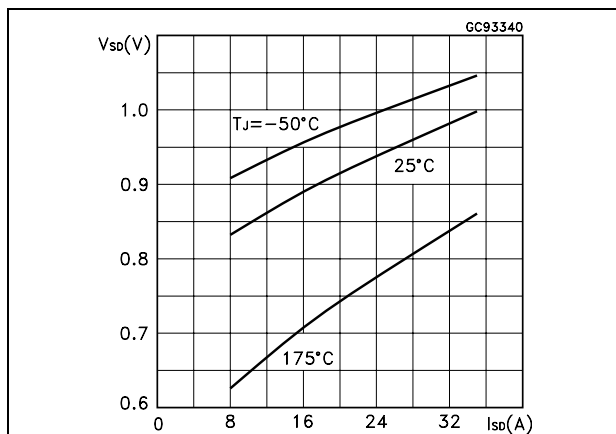

Figure 11. Source-drain diode forward characteristics



3 Test circuit

Figure 12. Switching times test circuit for resistive load



Figure 13. Gate charge test circuit



Figure 14. Test circuit for inductive load switching and diode recovery times

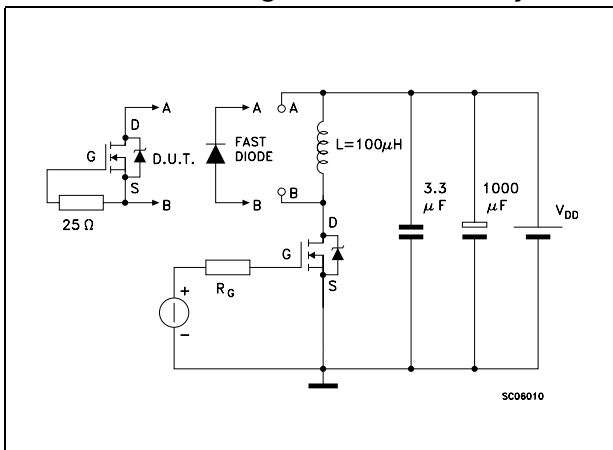

Figure 15. Unclamped Inductive load test circuit

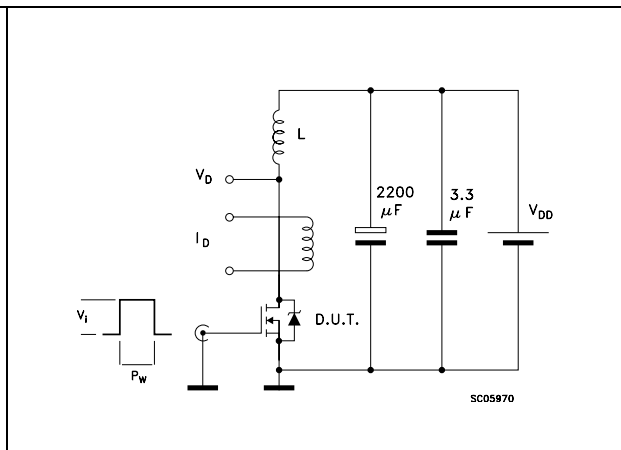
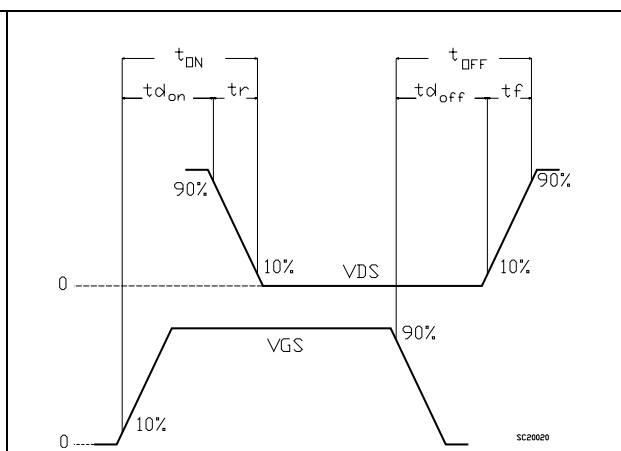

Figure 16. Unclamped inductive waveform



Figure 17. Switching time waveform



4 Package mechanical data

In order to meet environmental requirements, ST offers these devices in ECOPACK® packages. These packages have a Lead-free second level interconnect. The category of second level interconnect is marked on the package and on the inner box label, in compliance with JEDEC Standard JESD97. The maximum ratings related to soldering conditions are also marked on the inner box label. ECOPACK is an ST trademark. ECOPACK specifications are available at: www.st.com

DPAK MECHANICAL DATA

DIM.	mm.			inch		
	MIN.	TYP.	MAX.	MIN.	TYP.	MAX.
A	2.2		2.4	0.086		0.094
A1	0.9		1.1	0.035		0.043
A2	0.03		0.23	0.001		0.009
B	0.64		0.9	0.025		0.035
b4	5.2		5.4	0.204		0.212
C	0.45		0.6	0.017		0.023
C2	0.48		0.6	0.019		0.023
D	6		6.2	0.236		0.244
D1		5.1			0.200	
E	6.4		6.6	0.252		0.260
E1		4.7			0.185	
e		2.28			0.090	
e1	4.4		4.6	0.173		0.181
H	9.35		10.1	0.368		0.397
L	1			0.039		
(L1)		2.8			0.110	
L2		0.8			0.031	
L4	0.6		1	0.023		0.039
R		0.2			0.008	
V2	0°		8°	0°		8°

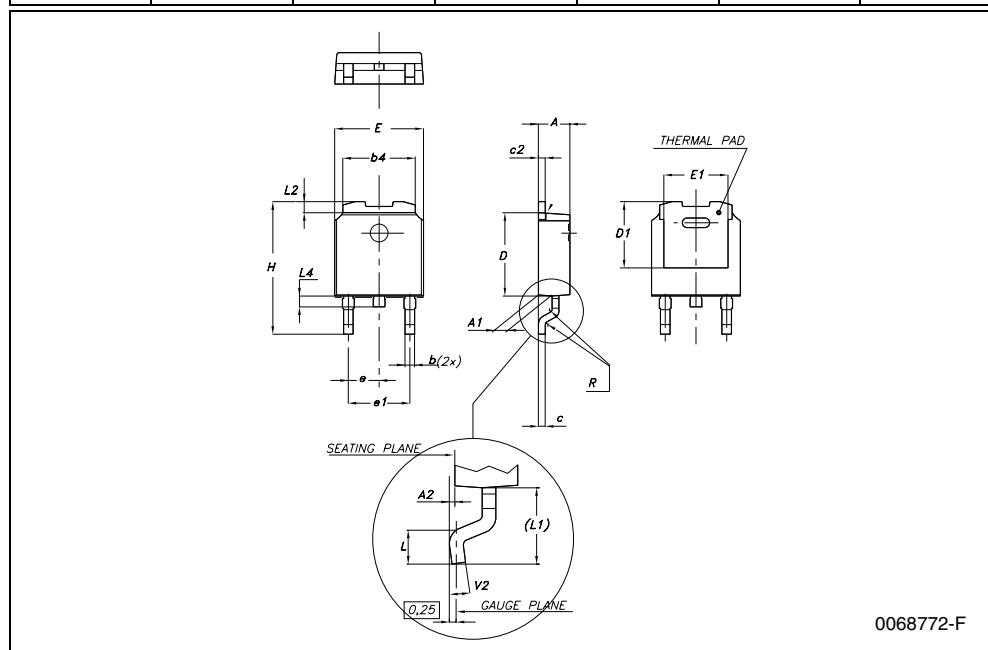

5 Packing mechanical data

DPAK FOOTPRINT

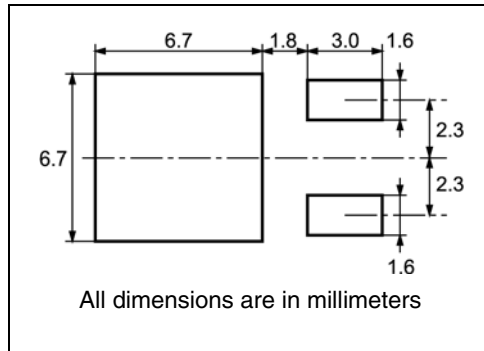

TAPE AND REEL SHIPMENT

40 mm min. Access hole at slot location

Full radius

Tape slot in core for tape start 2.5mm min. width

G measured at hub

REEL MECHANICAL DATA

DIM.	mm		inch	
	MIN.	MAX.	MIN.	MAX.
A		330		12.992
B	1.5		0.059	
C	12.8	13.2	0.504	0.520
D	20.2		0.795	
G	16.4	18.4	0.645	0.724
N	50		1.968	
T		22.4		0.881

TAPE MECHANICAL DATA

DIM.	mm		inch	
	MIN.	MAX.	MIN.	MAX.
A0	6.8	7	0.267	0.275
B0	10.4	10.6	0.409	0.417
B1		12.1		0.476
D	1.5	1.6	0.059	0.063
D1	1.5		0.059	
E	1.65	1.85	0.065	0.073
F	7.4	7.6	0.291	0.299
K0	2.55	2.75	0.100	0.108
P0	3.9	4.1	0.153	0.161
P1	7.9	8.1	0.311	0.319
P2	1.9	2.1	0.075	0.082
R	40		1.574	
W	15.7	16.3	0.618	0.641

10 pitches cumulative tolerance on tape ± 0.2 mm

Center line of cavity

FEED DIRECTION

Bending radius R min.

6 Revision history

Table 6. Revision history

Date	Revision	Changes
21-Jun-2004	2	Preliminary version
06-Jul-2006	3	New template, no content change
14-sep-2006	4	Removed IPAK
20-Feb-2007	5	Typo mistake on page 1

Please Read Carefully:

Information in this document is provided solely in connection with ST products. STMicroelectronics NV and its subsidiaries ("ST") reserve the right to make changes, corrections, modifications or improvements, to this document, and the products and services described herein at any time, without notice.

All ST products are sold pursuant to ST's terms and conditions of sale.

Purchasers are solely responsible for the choice, selection and use of the ST products and services described herein, and ST assumes no liability whatsoever relating to the choice, selection or use of the ST products and services described herein.

No license, express or implied, by estoppel or otherwise, to any intellectual property rights is granted under this document. If any part of this document refers to any third party products or services it shall not be deemed a license grant by ST for the use of such third party products or services, or any intellectual property contained therein or considered as a warranty covering the use in any manner whatsoever of such third party products or services or any intellectual property contained therein.

UNLESS OTHERWISE SET FORTH IN ST'S TERMS AND CONDITIONS OF SALE ST DISCLAIMS ANY EXPRESS OR IMPLIED WARRANTY WITH RESPECT TO THE USE AND/OR SALE OF ST PRODUCTS INCLUDING WITHOUT LIMITATION IMPLIED WARRANTIES OF MERCHANTABILITY, FITNESS FOR A PARTICULAR PURPOSE (AND THEIR EQUIVALENTS UNDER THE LAWS OF ANY JURISDICTION), OR INFRINGEMENT OF ANY PATENT, COPYRIGHT OR OTHER INTELLECTUAL PROPERTY RIGHT.

UNLESS EXPRESSLY APPROVED IN WRITING BY AN AUTHORIZED ST REPRESENTATIVE, ST PRODUCTS ARE NOT RECOMMENDED, AUTHORIZED OR WARRANTED FOR USE IN MILITARY, AIR CRAFT, SPACE, LIFE SAVING, OR LIFE SUSTAINING APPLICATIONS, NOR IN PRODUCTS OR SYSTEMS WHERE FAILURE OR MALFUNCTION MAY RESULT IN PERSONAL INJURY, DEATH, OR SEVERE PROPERTY OR ENVIRONMENTAL DAMAGE. ST PRODUCTS WHICH ARE NOT SPECIFIED AS "AUTOMOTIVE GRADE" MAY ONLY BE USED IN AUTOMOTIVE APPLICATIONS AT USER'S OWN RISK.

Resale of ST products with provisions different from the statements and/or technical features set forth in this document shall immediately void any warranty granted by ST for the ST product or service described herein and shall not create or extend in any manner whatsoever, any liability of ST.

ST and the ST logo are trademarks or registered trademarks of ST in various countries.

Information in this document supersedes and replaces all information previously supplied.

The ST logo is a registered trademark of STMicroelectronics. All other names are the property of their respective owners.

© 2007 STMicroelectronics - All rights reserved

STMicroelectronics group of companies

Australia - Belgium - Brazil - Canada - China - Czech Republic - Finland - France - Germany - Hong Kong - India - Israel - Italy - Japan - Malaysia - Malta - Morocco - Singapore - Spain - Sweden - Switzerland - United Kingdom - United States of America

www.st.com