



TS925

Rail-to-Rail High Output Current Quad Operational Amplifiers With Standby Mode and Adjustable Phantom Ground

- Rail-to-rail input and output
- Low noise: 9nV/ $\sqrt{\text{Hz}}$
- Low distortion
- High output current: 80mA (able to drive 32 Ω loads)
- High-speed: 4MHz, 1.3V/ μs
- Operating from 2.7V to 12V
- Low input offset voltage: 900 μV max. (TS925A)
- Adjustable phantom ground ($V_{CC}/2$)
- Standby mode
- ESD internal protection: 2kV
- Latch-up immunity

Description

The TS925 is a rail-to-rail quad BiCMOS operational amplifier optimized and fully specified for 3V and 5V operation.

High output current allows low load impedances to be driven. An internal low impedance **phantom ground** eliminates the need for an external reference voltage or biasing arrangement.

The TS925 exhibits very low noise, low distortion and high output current making this device an excellent choice for high quality, low voltage or battery operated audio/telecom systems.

The device is stable for capacitive loads up to 500pF. When the STANDBY mode is enabled, the total consumption drops to 6 μA ($V_{CC} = 3\text{V}$).

Applications

- Headphone amplifier
- Soundcard amplifier, piezoelectric speaker
- MPEG boards, multimedia systems...
- Cordless telephones and portable communication equipment
- Line driver, buffer
- Instrumentation with low noise as key factor



N
DIP16
(Plastic Package)

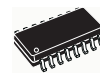

D
SO-16
(Plastic Micropackage)



P
TSSOP16
(Thin Shrink Small Outline Package)

Pin connections (top view)

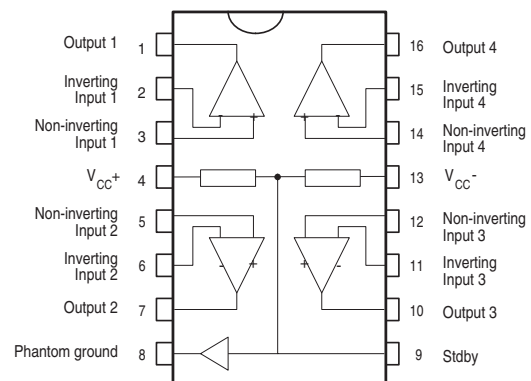

Order Codes

Part Number	Temperature Range	Package	Packing	Marking
TS925IN	-40°C to +125°C	DIP16	DIP16	TS925IN
TS925ID/IDT		SO-16	SO-16	925I
TS925IPT		TSSOP16	TSSOP16	
TS925AIN		DIP16	DIP16	TS925AIN
TS925AID		SO-16	SO-16	925AI
TS925AIPT		TSSOP16	TSSOP16	

1 Absolute Maximum Ratings

Table 1. Key parameters and their absolute maximum ratings

Symbol	Parameter	Condition	Value	Unit
V _{CC}	Supply voltage ⁽¹⁾		14	V
V _{id}	Differential Input Voltage ⁽²⁾		±1	V
V _i	Input Voltage		V _{DD} -0.3 to V _{CC} +0.3	V
T _J	Maximum Junction Temperature		150	°C
R _{thja}	Thermal Resistance Junction to Ambient	SO-16 TSSOP16 DIP16	95 95 63	°C/W
R _{thjc}	Thermal Resistance Junction to Case	SO-16 TSSOP16 DIP16	30 25 33	°C/W
ESD	Electro-Static Discharge	HBM Human Body Model ⁽³⁾	2	kV
		MM Machine Model ⁽⁴⁾	200	V
		CDM Charged Device Model	1	kV
	Output Short Circuit Duration		see note ⁽⁵⁾	
	Latch-up Immunity		200	mA
	Soldering Temperature	10sec, Pb-free package	260	°C

- All voltage values, except differential voltage are with respect to network ground terminal.
- Differential voltages are the non-inverting input terminal with respect to the inverting input terminal. If V_{id} > ±1V, the maximum input current must not exceed ±1mA. In this case (V_{id} > ±1V) an input series resistor must be added to limit input current.
- Human body model, 100pF discharged through a 1.5kΩ resistor into pin of device.
- Machine model ESD, a 200pF cap is charged to the specified voltage, then discharged directly into the IC with no external series resistor (internal resistor < 5Ω), into pin to pin of device.
- There is no short-circuit protection inside the device: short-circuits from the output to V_{CC} can cause excessive heating. The maximum output current is approximately 80mA, independent of the magnitude of V_{CC}. Destructive dissipation can result from simultaneous short-circuits on all amplifiers.

Table 2. Operating conditions

Symbol	Parameter	Value	Unit
V _{CC}	Supply Voltage	2.7 to 12	V
V _{icm}	Common Mode Input Voltage Range	V _{DD} -0.2 to V _{CC} +0.2	V
T _{oper}	Operating Free Air Temperature Range	-40 to +125	°C

2 Electrical Characteristics

Table 3. Electrical characteristics for $V_{CC} = 3V$, $V_{DD} = 0V$, $V_{icm} = V_{CC}/2$, R_L connected to $V_{CC}/2$, $T_{amb} = 25^\circ C$ (unless otherwise specified)

Symbol	Parameter	Conditions	Min.	Typ.	Max.	Unit
V_{io}	Input Offset Voltage	at $T_{amb} = +25^\circ C$ TS925 TS925A at $T_{min.} \leq T_{amb} \leq T_{max.}$ TS925 TS925A			3 0.9 5 1.8	mV
DV_{io}	Input Offset Voltage Drift			2		$\mu V/^\circ C$
I_{io}	Input Offset Current	$V_{out} = 1.5V$		1	30	nA
I_{ib}	Input Bias Current	$V_{out} = 2.5V$		15	100	nA
V_{OH}	High Level Output Voltage	$R_L = 10k\Omega$ $R_L = 600\Omega$ $R_L = 32\Omega$	2.90 2.87	2.63		V
V_{OL}	Low Level Output Voltage	$R_L = 10k\Omega$ $R_L = 600\Omega$ $R_L = 32\Omega$		180	50 100	mV
A_{vd}	Large Signal Voltage Gain	$V_{out} = 2V_{pk-pk}$ $R_L = 10k\Omega$ $R_L = 600\Omega$ $R_L = 32\Omega$		200 35 16		V/mV
GBP	Gain Bandwidth Product	$R_L = 600\Omega$		4		MHz
CMR	Common Mode Rejection Ratio		60	80		dB
SVR	Supply Voltage Rejection Ratio	$V_{CC} = 2.7$ to $3.3V$	60	85		dB
I_o	Output Short-Circuit Current		50	80		mA
SR	Slew Rate		0.7	1.3		V/ μs
Pm	Phase Margin at Unit Gain	$R_L = 600\Omega$, $C_L = 100pF$		68		Degrees
GM	Gain Margin	$R_L = 600\Omega$, $C_L = 100pF$		12		dB
e_n	Equivalent Input Noise Voltage	$f = 1kHz$		9		$\frac{nV}{\sqrt{Hz}}$
THD	Total Harmonic Distortion	$V_{out} = 2V_{pk-pk}$, $f = 1kHz$, $A_v = 1$, $R_L = 600\Omega$		0.01		%
C_s	Channel Separation			120		dB

Table 4. Global circuit

Symbol	Parameter	Conditions	Min.	Typ	Max.	Unit
I_{CC}	Total Supply Current	No load, $V_{out} = V_{cc}/2$		5	7	mA
I_{stby}	Total Supply Current in STANDBY	Pin 9 connected to V_{cc-}		6		μ A
V_{enstby}	Pin 9 Voltage to enable the STANDBY mode ⁽¹⁾	at $T_{amb} = +25^{\circ}C$ at $T_{min} \leq T_{amb} \leq T_{max}$			0.3 0.4	V
V_{distby}	Pin 9 Voltage to disable the STANDBY mode ⁽¹⁾	at $T_{amb} = +25^{\circ}C$ at $T_{min} \leq T_{amb} \leq T_{max}$	1.1 1			V

1. The STANDBY mode is currently enabled when Pin 9 is GROUNDED and disabled when Pin 9 is left OPEN.

Table 5. Phantom ground

Symbol	Parameter	Conditions	Min.	Typ	Max.	Unit
V_{pg}	Phantom Ground Output Voltage	No Output Current	$V_{cc}/2$ -5%	$V_{cc}/2$	$V_{cc}/2$ +5%	V
I_{pgsc}	Phantom Ground Output Short Circuit Current - Sourced		12	18		mA
Z_{pg}	Phantom Ground Impedance	DC to 20kHz		3		Ω
E_{npg}	Phantom Ground Output Voltage Noise	$f = 1kHz$ $C_{dec} = 100pF$ $C_{dec} = 1nF$ $C_{dec} = 10nF^{(1)}$		200 40 17		$\frac{nV}{\sqrt{Hz}}$
I_{pgsk}	Phantom Ground Output Short Circuit Current - Sunked		12	18		mA

1. C_{dec} is the decoupling capacitor on Pin9.

Table 6. Electrical characteristics for $V_{CC} = 5V$, $V_{DD} = 0V$, $V_{icm} = V_{CC}/2$, R_L connected to $V_{CC}/2$, $T_{amb} = 25^\circ C$ (unless otherwise specified)

Symbol	Parameter	Conditions	Min.	Typ.	Max.	Unit
V_{io}	Input Offset Voltage	at $T_{amb} = +25^\circ C$: TS925 TS925A at $T_{min.} \leq T_{amb} \leq T_{max.}$: TS925 TS925A			3 0.9 5 1.8	mV
DV_{io}	Input Offset Voltage Drift			2		$\mu V/^\circ C$
I_{io}	Input Offset Current	$V_{out} = 2.5V$		1	30	nA
I_{ib}	Input Bias Current	$V_{out} = 2.5V$		15	100	nA
V_{OH}	High Level Output Voltage	$R_L = 10k\Omega$ $R_L = 600\Omega$ $R_L = 32\Omega$	4.90 4.85	4.4		V
V_{OL}	Low Level Output Voltage	$R_L = 10k\Omega$ $R_L = 600\Omega$ $R_L = 32\Omega$		300	50 120	mV
A_{vd}	Large Signal Voltage Gain	$V_{out} = 2V_{pk-pk}$ $R_L = 10k$ $R_L = 600\Omega$ $R_L = 32\Omega$		200 40 17		V/mV
GBP	Gain Bandwidth Product	$R_L = 600\Omega$		4		MHz
CMR	Common Mode Rejection Ratio		60	80		dB
SVR	Supply Voltage Rejection Ratio	$V_{CC} = 3$ to $5V$	60	85		dB
I_o	Output Short-Circuit Current		50	80		mA
SR	Slew Rate		0.7	1.3		V/ μs
Pm	Phase Margin at Unit Gain	$R_L = 600\Omega$, $C_L = 100pF$		68		Degrees
GM	Gain Margin	$R_L = 600\Omega$, $C_L = 100pF$		12		dB
e_n	Equivalent Input Noise Voltage	$f = 1kHz$		9		$\frac{nV}{\sqrt{Hz}}$
THD	Total Harmonic Distortion	$V_{out} = 2V_{pk-pk}$, $f = 1kHz$, $A_v = 1$, $R_L = 600\Omega$		0.01		%
C_s	Channel Separation			120		dB

Table 7. Global circuit

Symbol	Parameter	Conditions	Min.	Typ	Max.	Unit
I_{CC}	Total Supply Current	No load, $V_{out} = V_{cc}/2$		6	8	mA
I_{stby}	Total Supply Current in STANDBY	Pin 9 connected to V_{cc}		6		μ A
V_{enstby}	Pin 9 Voltage to enable the STANDBY mode ⁽¹⁾	at $T_{amb} = +25^{\circ}\text{C}$ at $T_{min} \leq T_{amb} \leq T_{max}$			0.3 0.4	V
V_{distby}	Pin 9 Voltage to disable the STANDBY mode ⁽¹⁾	at $T_{amb} = +25^{\circ}\text{C}$ at $T_{min} \leq T_{amb} \leq T_{max}$	1.1 1			V

1. the STANDBY mode is currently enabled when Pin 9 is GROUNDED and disabled when Pin 9 is left OPEN.

Table 8. Phantom ground

Symbol	Parameter	Conditions	Min.	Typ	Max.	Unit
V_{pg}	Phantom Ground Output Voltage	No Output Current	$V_{cc}/2$ -5%	$V_{cc}/2$	$V_{cc}/2$ +5%	V
I_{pgsc}	Phantom Ground Output Short Circuit Current - Sourced		12	18		mA
Z_{pg}	Phantom Ground Impedance	DC to 20kHz		3		Ω
E_{npg}	Phantom Ground Output Voltage Noise	$f = 1\text{kHz}$ $C_{dec} = 100\text{pF}$ $C_{dec} = 1\text{nF}$ $C_{dec} = 10\text{nF}^{(1)}$		200 40 17		$\frac{\text{nV}}{\sqrt{\text{Hz}}}$
I_{pgsk}	Phantom Ground Output Short Circuit Current - Sunked		12	18		mA

1. C_{dec} is the decoupling capacitor on Pin9.

Figure 1. Input offset voltage distribution

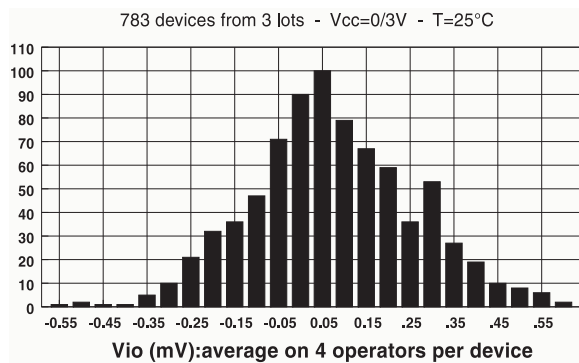

Figure 2. Total supply current vs. supply voltage with no load

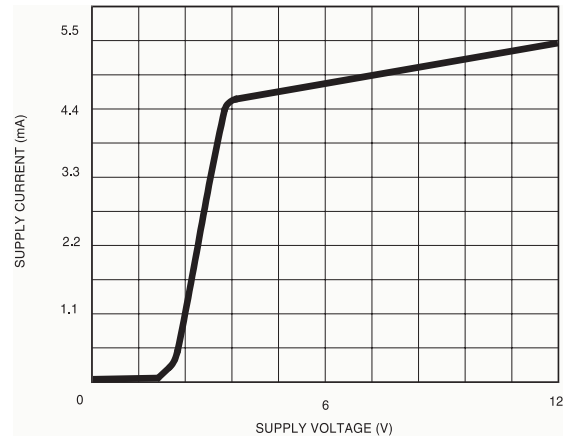

Figure 3. Supply current/amplifier vs. temperature

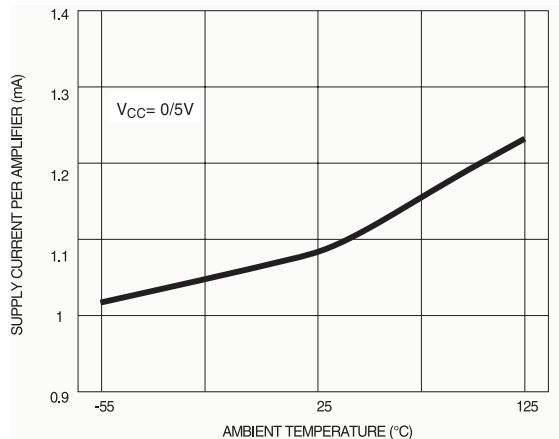

Figure 4. Output short circuit current vs. output voltage

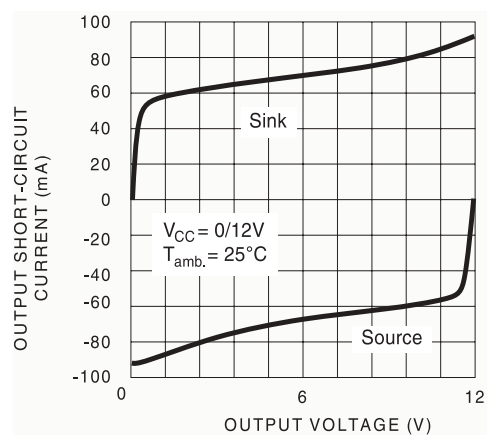

Figure 5. Output short circuit current vs. output voltage

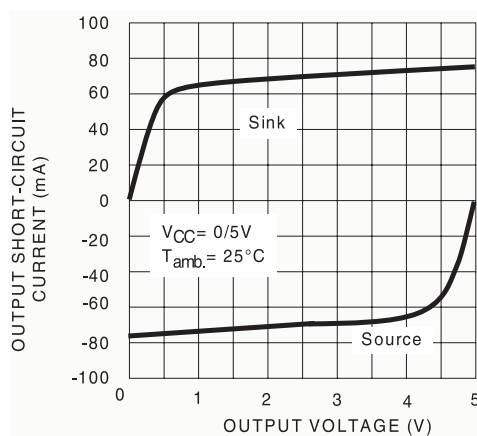

Figure 6. Output short circuit current vs. output voltage

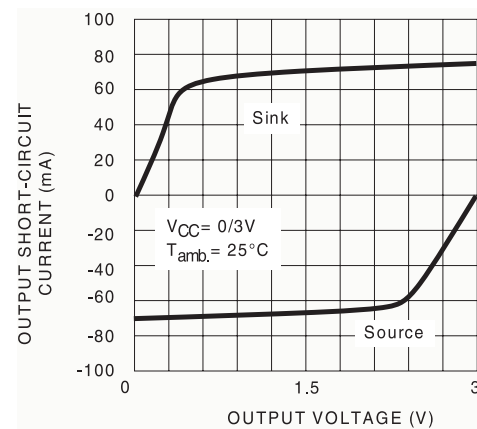

Figure 7. Output short circuit current vs. temperature

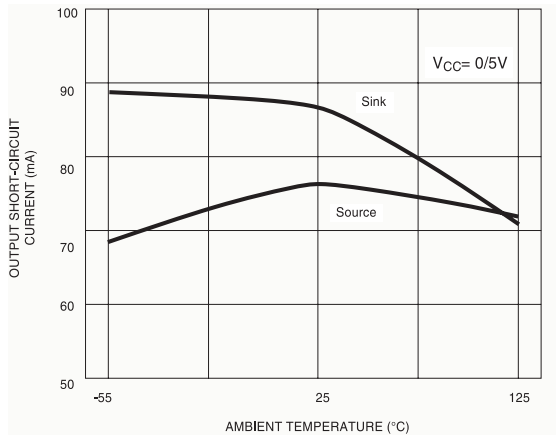

Figure 8. Voltage gain and phase vs. frequency

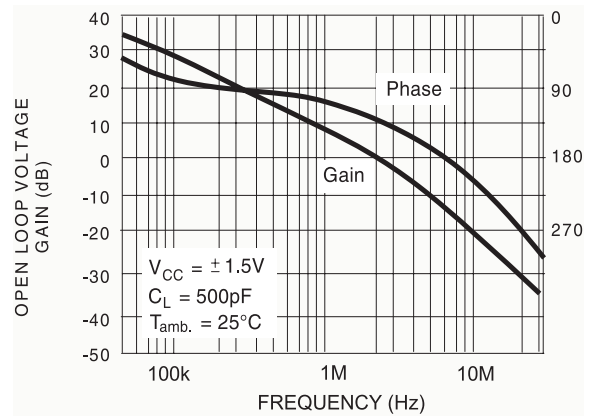

Figure 9. Distortion + noise vs. frequency

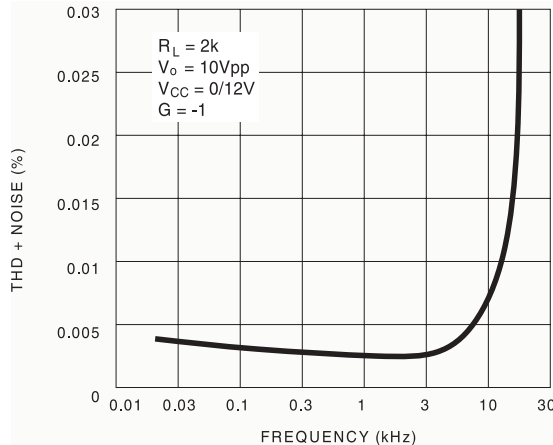

Figure 10. THD + noise vs. frequency

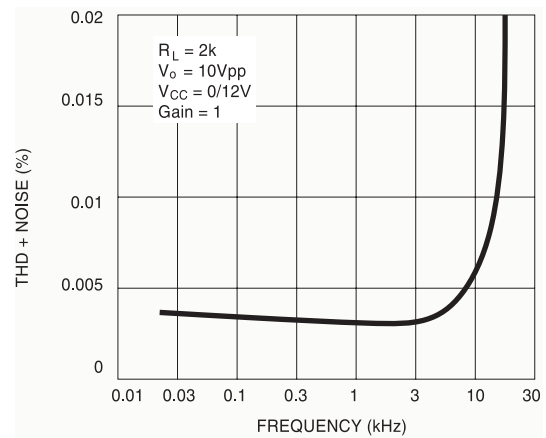

Figure 11. THD + noise vs. frequency

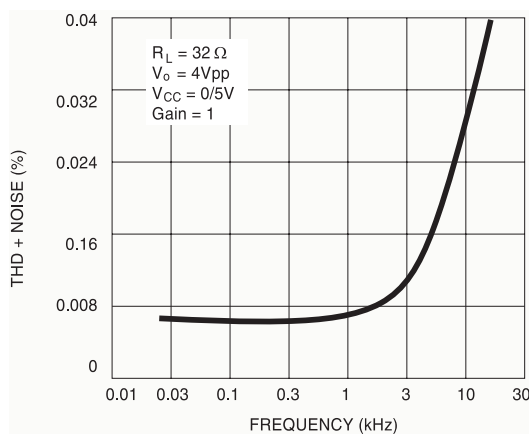

Figure 12. THD + noise vs. frequency

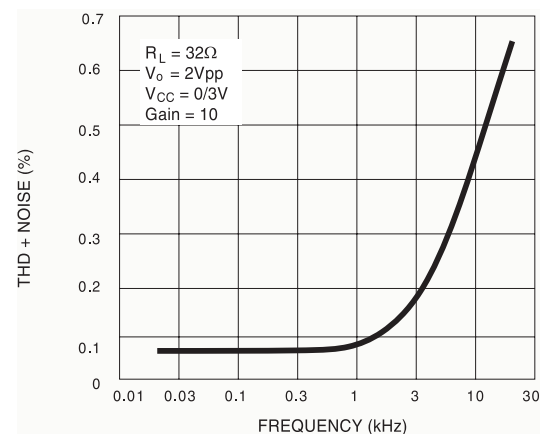

Figure 13. Equivalent input noise vs. frequency

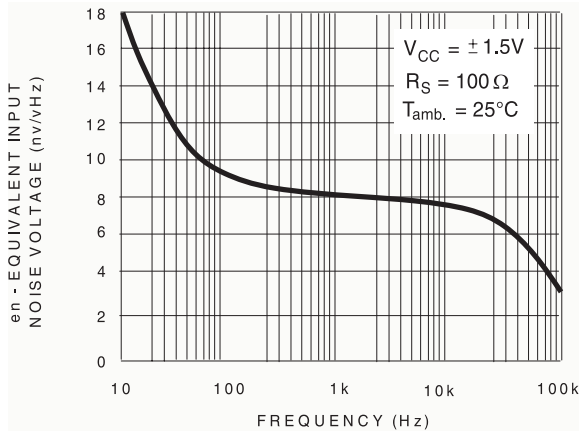

Figure 14. Total supply current vs. standby input voltage

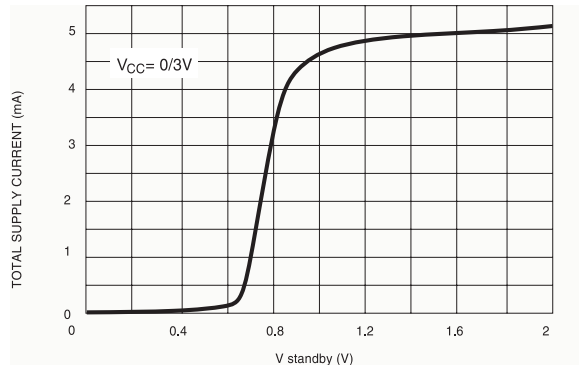
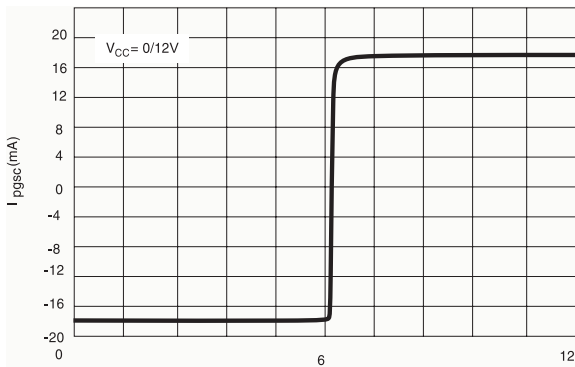

Figure 15. Phantom ground short circuit output current vs. phantom ground output voltage



3 Using the TS925 as a preamplifier and speaker driver

The TS925 is an input/output rail-to-rail quad BiCMOS operational amplifier. It is able to operate with low supply voltages (2.7V) and to drive low output loads such as 32Ω.

As an illustration of these features, the following technical note highlights many of the advantages of the device in a global audio application.

3.1 Application circuit

Figure 16 shows two operators (A1, A4) used in a preamplifier configuration, and the two others in a push-pull configuration driving a headset. The phantom ground is used as a common reference level ($V_{CC}/2$).

The power supply is delivered from two LR6 batteries (2 x 1.5V nominal).

Preamplifier

The operators A1 and A4 are wired with a non-inverting gain of respectively:

- A1# ($R4/(R3+R17)$)
- A4# $R6/R5$

With the following values chosen:

- $R4 = 22k\Omega$ - $R3 = 50\Omega$ - $R17 = 1.2k\Omega$
- $R6 = 47k\Omega$ - $R5 = 1.2k\Omega$,

The gain of the preamplifier chain is therefore equal to 58dB.

Alternatively, the gain of A1 can be adjusted by choosing a JFET transistor Q1 instead of R17.

This JFET voltage controlled resistor arrangement forms an automatic level control (ALC) circuit, useful in many microphone preamplifier applications. The mean rectified peak level of the output signal envelope is used to control the preamplifier gain.

Figure 16. Electrical schematic

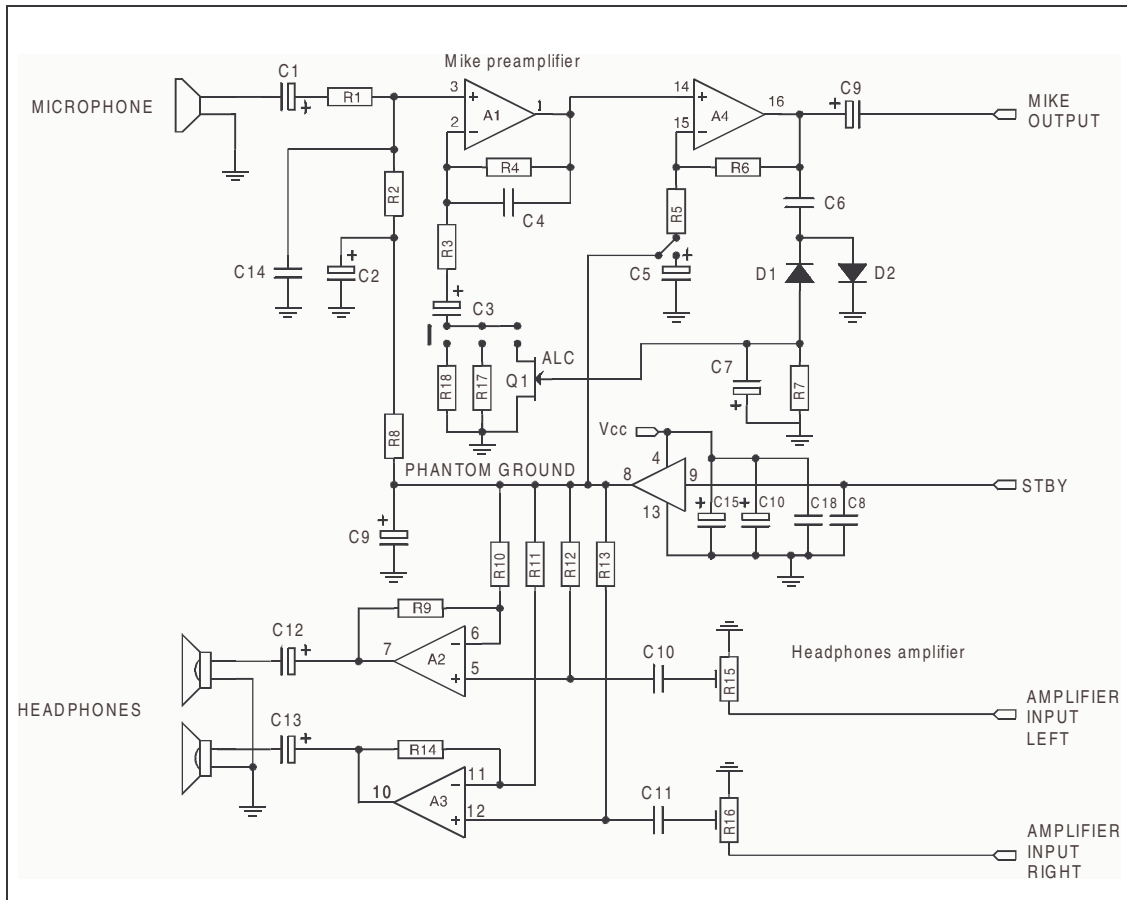

Headphone amplifier

The operators A2 and A3 are organized in a push-pull configuration with a gain of 5. The stereo inputs can be connected to a CD-player and the TS925 can directly drive the head-phone speakers. This configuration shows the ability of the circuit to drive 32Ω load with a maximum output swing and high fidelity suitable for sound and music.

Figure 19 shows the available signal swing at the headset outputs: two other rail-to-rail competitor parts are employed in the same circuit for comparison (note the much reduced clipping level and crossover distortion).

Figure 17. Frequency response of the global preamplifier chain

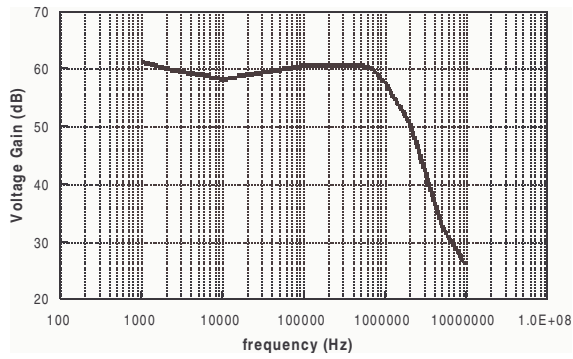

Figure 18. Voltage noise density vs. frequency at preamplifier output

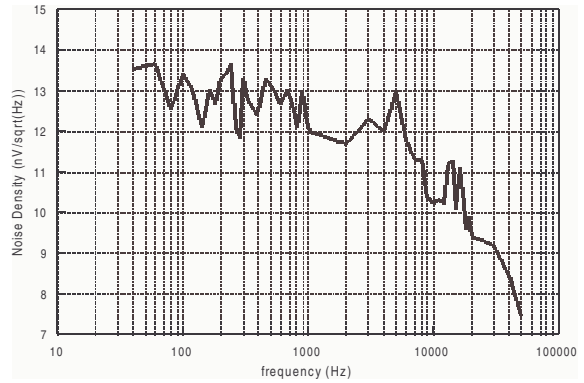

Figure 19. Maximum voltage swing at headphone outputs ($R_L = 32\Omega$)

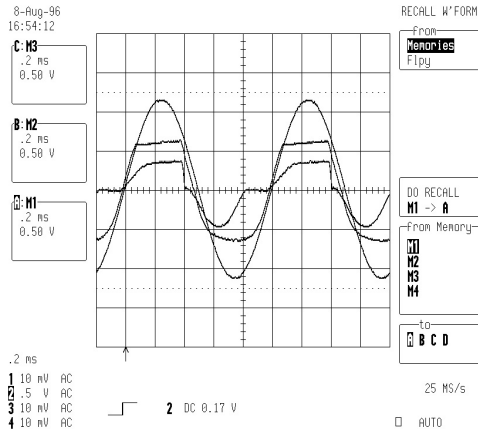
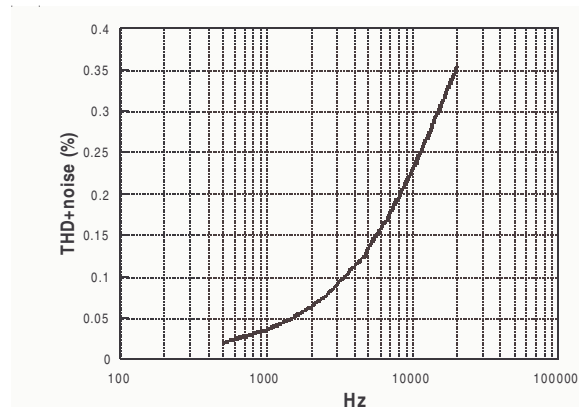

Figure 20. THD + noise vs. frequency (headphone outputs)



4 Package Mechanical Data

In order to meet environmental requirements, ST offers these devices in ECOPACK® packages. These packages have a Lead-free second level interconnect. The category of second level interconnect is marked on the package and on the inner box label, in compliance with JEDEC Standard JESD97. The maximum ratings related to soldering conditions are also marked on the inner box label. ECOPACK is an ST trademark. ECOPACK specifications are available at: www.st.com.

4.1 DIP16 Package

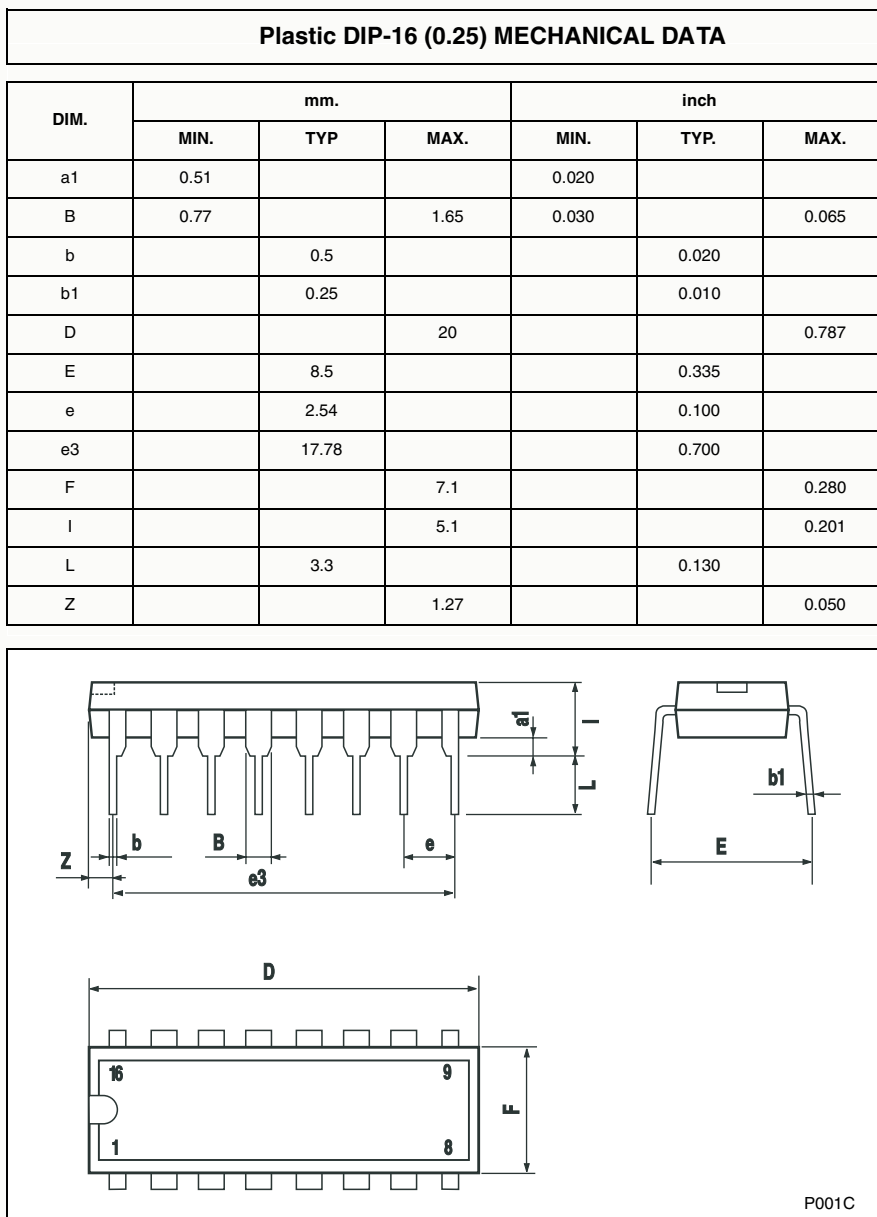

4.2 SO-16 Package

SO-16 MECHANICAL DATA						
DIM.	mm.			inch		
	MIN.	TYP.	MAX.	MIN.	TYP.	MAX.
A			1.75			0.068
a1	0.1		0.2	0.004		0.008
a2			1.65			0.064
b	0.35		0.46	0.013		0.018
b1	0.19		0.25	0.007		0.010
C		0.5			0.019	
c1	45° (typ.)					
D	9.8		10	0.385		0.393
E	5.8		6.2	0.228		0.244
e		1.27			0.050	
e3		8.89			0.350	
F	3.8		4.0	0.149		0.157
G	4.6		5.3	0.181		0.208
L	0.5		1.27	0.019		0.050
M			0.62			0.024
S	8			° (max.)		

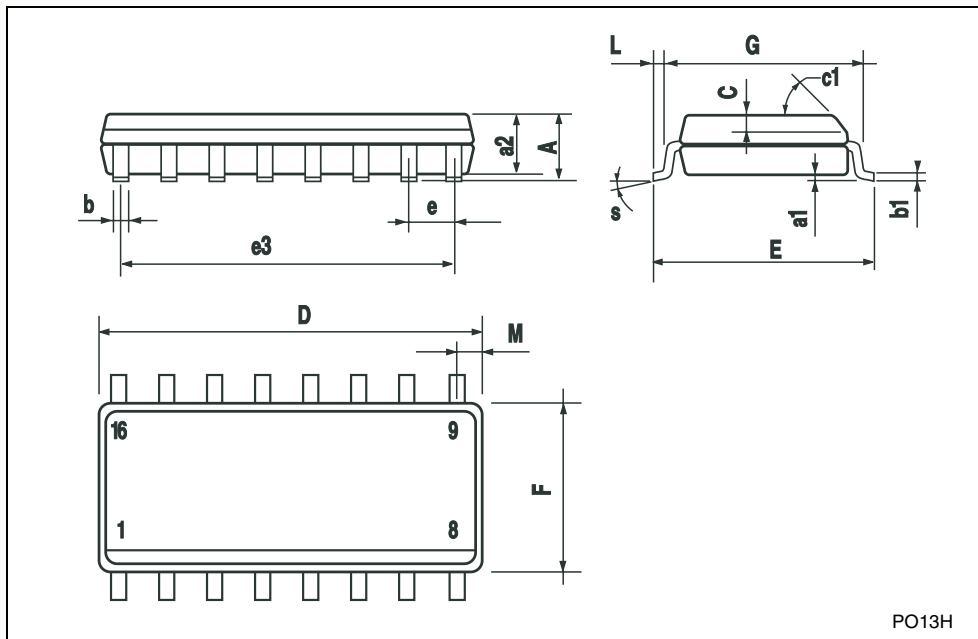

PO13H

4.3 TSSOP16 Package

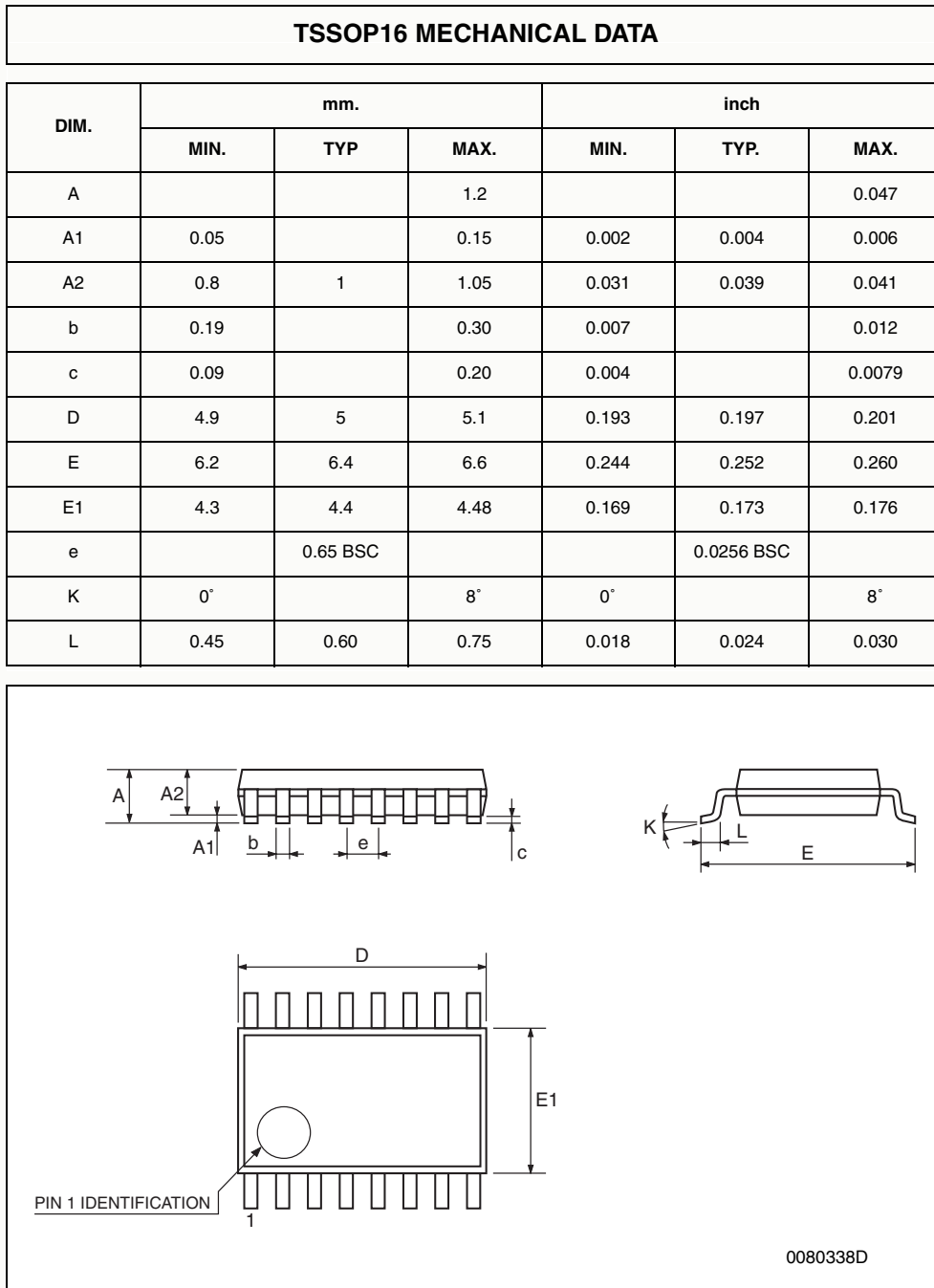

5 Revision History

Date	Revision	Changes
Feb. 2001	1	Initial release - Product in full production.
Nov. 2005	2	<p>The following changes were made in this revision:</p> <ul style="list-style-type: none"> – Chapter on Macromodels removed from the datasheet. – Data updated in <i>Table 3. on page 4.</i> – Data in tables in <i>Electrical Characteristics on page 4</i> reformatted for easier use. – Minor grammatical and formatting changes throughout.

Information furnished is believed to be accurate and reliable. However, STMicroelectronics assumes no responsibility for the consequences of use of such information nor for any infringement of patents or other rights of third parties which may result from its use. No license is granted by implication or otherwise under any patent or patent rights of STMicroelectronics. Specifications mentioned in this publication are subject to change without notice. This publication supersedes and replaces all information previously supplied. STMicroelectronics products are not authorized for use as critical components in life support devices or systems without express written approval of STMicroelectronics.

The ST logo is a registered trademark of STMicroelectronics.
All other names are the property of their respective owners

© 2005 STMicroelectronics - All rights reserved

STMicroelectronics group of companies

Australia - Belgium - Brazil - Canada - China - Czech Republic - Finland - France - Germany - Hong Kong - India - Israel - Italy - Japan - Malaysia - Malta - Morocco - Singapore - Spain - Sweden - Switzerland - United Kingdom - United States of America

www.st.com